

Hamilton Reference Guide

Syringes & Needles





Syringes

Introduction 4

- I have a syringe, what's the part number?6
- I know my dispense volume, which syringe is right?8
- I have a syringe, which needle do I need?9
- Syringe 101: Definitions and Terminology 10

General Syringes 14

- Microliter Syringes 16
 - 600 Series Syringes 17
 - 700 Series Syringes 17
 - 800 Series Syringes 18
 - 7000 Series Syringes 19
- Gastight Syringes 20
 - 1700 Series Syringes 21
 - 1800 Series Syringes 23
 - 1000 Series Syringes 24
 - Super Syringes 25
- Calibrated Syringes 26
- Digital Syringes 27

Chromatography and Analysis Syringes 28

- Manual HPLC Syringes 30
 - Rheodyne, Valco, Beckman, and SSI Valves 31
 - Constant Rate Syringes 31
 - Valco VISF-1 Injection Valves 32
 - Waters Manual Syringes 32

- HPLC Autosampler Syringes 33
 - CTC LEAP Syringes 34
 - CTC PAL Syringes 34
 - Dionex Gina Syringes 35
 - Hitachi LaChrom Syringes 35
 - Kontron HPLC Syringes 36
 - Perkin Elmer Syringes 36
 - Shimadzu Syringes 36
 - Spark Holland Syringes 37
 - Thermo Finnigan Syringes 37
 - Varian Syringes 38
 - Waters Syringes 38
- Manual GC Syringes 39
 - Standard Injection 40
 - Purge and Trap Syringes 42
 - SampleLock Syringes 42
 - On-Column Injection Syringes 43
- GC Autosampler Syringes 44
 - Agilent Syringes 45
 - Bruker Varian Syringes 49
 - CTC / LEAP PAL GC Syringes 50
 - CTC / LEAP CombiPAL (Headspace) Syringes 51
 - Perkin Elmer AutoSystem and Clarus Syringes 52
 - Shimadzu Syringes 52
 - Thermo Finnigan Syringes 53
- Thin-Layer Chromatography (TLC) Syringes 54
- Carbon Analyzer Syringes 55





Life Science Syringes 56

Neuros Syringes..... 58

Syringes Connected to:..... 60

 Small Gauge Needles62

 Glass Micro Pipettes62

 PE Tubing62

 PEEK Tubing 63

 Priming Kit 63

Specialty Syringes..... 64

 Threaded Plunger Syringes..... 64

 Gel-Loading Syringes 64

 Adjustable Gel-Loading Syringes 65

 Micro Syringe Pipette..... 65

Syringe and Cleaning Accessories 66

Plunger Support Accessories..... 68

 Reproducibility (Chaney) Adapters 69

 Syringe Guides70

Syringe Storage and Cleaning.....71

 Syringe Rack.....71

 Needle Cleaning.....72

Syringe Termination Adapters73

 Removable Needle to Luer Adapters73

 Inert Sampling Valve74

 Septum Adapter.....74

PB-600 Repeating Dispenser.....75

Syringe Technical Reference 76

Syringe Care and Use77

 Daily Use Protocol.....77

 Plunger Care.....79

 Needle Care.....79

Syringe Specifications 80

 Operating Parameters..... 80

 Syringe Dimensions 80

 Graduations81

Syringe Replacement Parts.....82

 800 Series Syringe Replacement Parts.....82

 1000 Series Syringe Replacement Parts..... 83

 1700 Series Syringe Replacement Parts..... 83

 1800 Series Syringe Replacement Parts..... 83

 7000 Series Syringe Replacement Parts..... 84

 Super Syringe Replacement Parts 84

Sterilization and Disinfection..... 85

Frequently Asked Questions..... 86

Syringe Calibration 89

 Equipment and Materials 89

 Calibration Procedure 90

 Calculating Accuracy and Precision91

Needles 94

Index 120





Syringes

Hamilton syringes are the finest precision fluid measuring devices available. Top quality materials and skilled workmanship ensure Hamilton syringes consistently deliver the highest possible performance for reliable analyses. With proper care and handling, Hamilton syringes provide unsurpassed performance for many years.

For manual dispenses, our syringes are accurate to within $\pm 1\%$ of nominal volume with a precision of 1% at 80% of the total volume. The fluid path of a Hamilton syringe is chemically inert with stainless steel, borosilicate glass, and PTFE used for most syringes. N.I.S.T. traceable certification is available as an additional service for the majority of the syringes in our product line.

Hamilton continuously researches new materials and methods to improve the form, fit, and function of our syringes. You can be confident that when you buy from Hamilton you are receiving a top-quality instrument. For the latest information on new products please visit www.hamiltoncompany.com.

Hamilton's broad product offering includes more than 2000 syringe and accessory part numbers. This reference guide organizes these parts into logical groupings and provides supporting technical information for the most commonly asked questions.



Introduction

Product finder tutorials simplify the process of finding the right syringe. Not familiar with the terminology? Visit the Syringe 101 section for definitions and terminology.



Introduction

P. 6

General Syringes

Syringes for general use that are grouped based on their syringe type, series, termination, and needle, if applicable.



General Syringes

P. 14

Chromatography and Analysis Syringes

These syringes are organized by their intended application and instrument compatibility. Write down the make and model of your equipment and turn to this section to find a compatible syringe.



Chromatography and Analysis Syringes

P. 28

Life Science Syringes

This section contains syringes designed for animal injections and accessories that adapt standard syringes for use with tubing, infusion pumps, stereotaxic frames, and other specialty applications.



Life Science Syringes

P. 56

Syringe and Cleaning Accessories

These syringe accessories are designed to increase dispense reproducibility, prevent syringe damage, and increase syringe longevity through proper maintenance.



Syringe and Cleaning Accessories

P. 66

Syringe Technical Reference

This section contains the most frequently requested syringe reference information including: care and use, calibration, operating parameters, and more.



Syringe Technical Reference

P. 76





Find Your Product

I have a syringe, what's the part number?

If you need to reorder a syringe but cannot find the part number, this tutorial will help guide you to the most likely syringe part number. Use the five steps below to fill in information about your syringe and then turn to the series page to see the possible part numbers.

Use the steps below to fill in these syringe details:

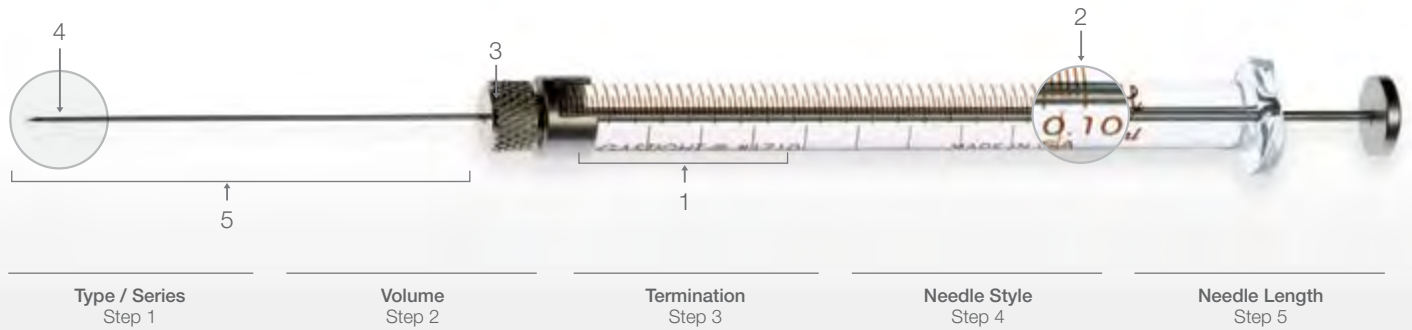

Step 1

Type / Series

The silk screen tells you the Syringe Type and Syringe Model number. Record the Type in the space provided above and then use the chart below to determine the Syringe Series. Using the Syringe Series, find the page in this guide where the part numbers for that series are displayed.

Microliter

600 Series
Model Numbers 62 – 65 P. 17

700 Series
Model Numbers 75 – 750 P. 17

800 Series
Model Numbers 85 – 825 P. 18

7000 Series
Model Numbers 7000.5 – 7105 P. 19

Gastight

1000 Series
Model Numbers 1001 – 1100 P. 24

1700 Series
Model Numbers 1701 – 1750 P. 21

1800 Series
Model Numbers 1801 – 1825 P. 23

Super Syringe
Model Numbers S0500 – S2000 P. 25



Step 2





Volume

The Syringe Model gives an indication of the syringe volume but it is easiest to read and record the volume by looking at the maximum volume silk screened onto the barrel.



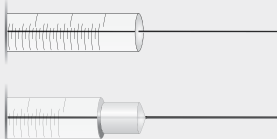

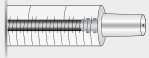

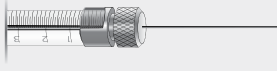
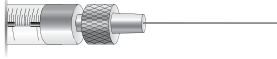
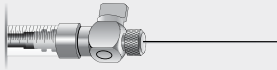
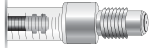
Step 3 Termination

The syringe termination is the connection between the syringe and needle. The illustrations below are the most common terminations. Pick the termination that matches your syringe and record the termination in the space provided. To see a complete list of terminations turn to page 12.

ID	Termination Style	Termination
N and SN		Cemented Needle
LTN and LTSN		Luer Tip Cemented Needle
LT		Luer Tip
TLL		PTFE Luer Lock
RN		Removable Needle
KH		Knurled Hub
SL		SampleLock™
C		ChemSeal

Step 4 Needle Style

Determine and record the needle point style by comparing the illustrations below to the needle on your syringe. For more information on point styles turn to page 13.

ID	Point Style	Description
2		10-12° sharp, beveled, curved non-coring
3		Blunt, electro-polished
4		Sharp 10-12° beveled needle
5		Conical with side port for penetration without coring
AS		Conical, non-coring designed to withstand multiple injections

Step 5 Needle Length

The standard needle length for a Hamilton syringe is 51 mm. If the length of your needle is not 51 mm it is likely that the needle was a custom order using either a special cemented needle termination or a removable needle termination with the needle sold separately.

The needle gauge dictates the inner and outer diameter of the needle. The optimal needle gauge has been preselected for most syringes based on the syringe volume. For special applications, larger or smaller needle gauges may be ordered via the SN or LTSN terminations or separately as a custom needle. A complete needle gauge index can be found on page 119.



I know my dispense volume, which syringe is right?

Use the table below to find which Syringe Series are available for the desired dispense volume, then turn to the appropriate Series page to see which terminations and needles are available for that Series.

Visit the following pages for more information on Syringe Type (page 11), Series (page 11), Termination (page 12), and Needle Point (page 13).

The Hamilton Syringe Type to Series Chart

Syringe Type	Delivery Volume	Syringe Series	Page
Microliter (Liquid Only)	0.05 μ L – 0.25 μ L	7000 Series	P. 19
	0.25 μ L – 0.5 μ L	600, 7000 Series	P. 17, P. 19
	0.5 μ L – 5 μ L	600, 700, 800, 7000 Series	P. 17, P. 17, P. 18, P. 19
	5 μ L – 250 μ L	700, 800 Series	P. 17, P. 18
	250 μ L – 500 μ L	700 Series	P. 17
Gastight (Gas/Liquid)	1 μ L – 100 μ L	1700, 1800 Series	P. 21, P. 23
	100 μ L – 250 μ L	1000, 1700, 1800 Series	P. 24, P. 21, P. 23
	250 μ L – 500 μ L	1000, 1700 Series	P. 24, P. 21
	500 μ L – 50 mL	1000 Series	P. 24
	50 mL – 100 mL	1000 Series, Super Syringe	P. 24, P. 25
	100 mL – 2 L	Super Syringe	P. 25

Note: For the highest accuracy and precision, avoid dispensing less than 10% of the total syringe volume.



I have a syringe, which needle do I need?

If you already have a syringe and need a Hamilton needle, review the three options below to determine which needle hub is compatible with your syringe. Once the needle hub is identified turn to the corresponding page to browse the available needle gauges, lengths, and point styles.

Option 1 I already know my syringe termination

Below are the syringe terminations that accept replacement needles. Identify your termination below and proceed to the corresponding needle hub page to see the compatible needle part numbers.

Terminations	Needle Hubs	Page
TLL - PTFE / Luer Lock	Metal Hub Kel-F Hub	P. 106 P. 105
LT - Luer Tip	Kel-F Hub	P. 105
RN - Removable Needle 100 μ L or Smaller	Small Hub RN	P. 109
RN - Removable Needle 250 μ L or Larger	Large Hub RN	P. 108
SL - Sample Lock	Large Hub RN	P. 108

Option 2 I know my syringe part number, but not the termination

If you know the syringe part number but do not know what termination it has, you can look up the part number in the index at the back of this guide. You will be directed to the page where the part number is displayed, indicating the syringe termination. Alternatively, you can search for the part number at www.hamiltoncompany.com where the product page will list the termination and the compatible needle hub. Once the termination is determined use Option 1 to find the page where the appropriate needles are listed.

Option 3 I have a plastic syringe and need a compatible needle

Many plastic syringes use an industry standard Luer or Luer Lock connector. For these syringes both the Hamilton Metal Hub (page 106) and the Kel-F Hub (page 105) needles are compatible.





Syringe 101:

Definitions and Terminology

This section is designed to provide a quick overview of the most popular Hamilton syringe series, plungers, needle connections, and

needle point styles. It is also intended to give an introduction to common terminology that will be used throughout the syringe reference guide.

Microliter Syringes

700 Series



P. 11

Modified Microliter Syringes

7000 Series



P. 11

Gastight Syringes

1700 Series and 1000 Series



P. 11

Reinforced Plunger Syringe

800 and 1800 Series



P. 12

Syringe Terminations

P. 12

Needle Point Styles

P. 13



Microliter Syringes (700 Series)

Microliter syringes are used with liquid only. They feature a stainless steel plunger which is individually fitted to the glass barrel. The result is a liquid tight seal with nearly frictionless movement. These syringes are ideal for organic samples that are not prone to precipitation, crystallization, or bonding with glass. Plungers and barrels are not interchangeable or replaceable.

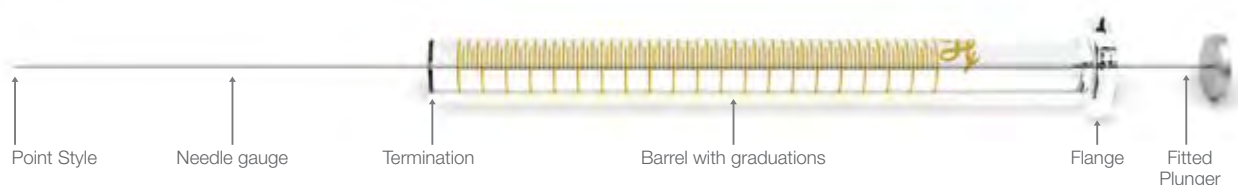

Modified Microliter Syringes (7000 Series)

These syringes are designed to dispense volumes below 5 μL . This requires an extremely small tungsten plunger wire that travels to the tip of the needle. The resulting design has zero dead volume and is accurate below 50 nL.

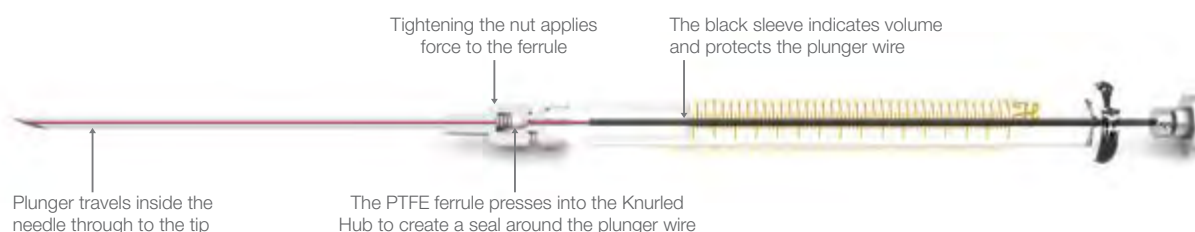

Gastight Syringes (1700 and 1000 Series)

Gastight syringes are ideal for dispensing both liquids and gases. They have a polymer plunger tip which creates a leak-free seal. Traditionally the tip is made from PTFE but other materials are used for selected applications. The polymer tip wipes the interior of the syringe barrel free of sample; extending the syringe life for samples with dissolved solids like salts, proteins, or DNA.





Gastight Syringes (1700 and 1000 Series) (Cont.)

Gastight syringes are used as the standard in syringe pumps. Syringes 1 mL and smaller are available with a plunger stop. This ensures that when the syringe pump bottoms out the stop hits on the glass before the fragile plunger tip is damaged. The stop is also tapped with a #6-32 hole in the back to enable connection to the syringe pump. Syringes larger than 1 mL also come standard with this threaded hole.





Reinforced Plunger Syringe (800 and 1800 Series)

Small volume syringes require extremely small plunger wires. For uses that are prone to bending and breaking these small plungers, it is recommended to use a reinforced plunger syringe. These plungers are available in both Microliter and Gastight versions.





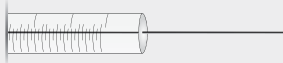

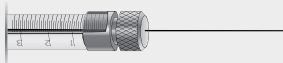

Syringe Terminations

Terminations are located at the end of the syringe barrel and function as the interface between the syringe and its mating connection such as the needle. Terminations are offered in a number of different needle and connection configurations to accommodate a broad range of applications.

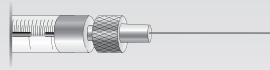
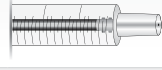
Termination	Abbreviation	Remark	Autoclavable
Cemented Needle 	N	For low-volume syringes	No
Luer Tip Cemented Needle 	LTN	For mid-volume syringes	No
Removable Needle 	RN	No dead volume connection Use with Small Hub needles (2.5 µL – 100 µL) or Large Hub needles (250 µL – 10 mL)	Yes, if disassembled









Syringe Terminations (Cont.)

Termination	Abbreviation	Remark	Autoclavable
 Knurled Hub	KH	For Modified Microliter syringes only	Yes, if disassembled
 Luer Tip	LT	Compatible with Kel-F needles and fittings	Yes, if disassembled
 PTFE Luer Lock	TLL	Compatible with Kel-F or Metal Hub needles and fittings	Yes, if disassembled
 SampleLock™	SL	Integrated on/off valve Use with Large Hub needles	No
 Fixed Needle	FN	Found on CTC C-Line and X-Type syringes	No
 High Temp	HT	For headspace sampling up to 200 °C on a CTC autosampler	Yes, if disassembled
 ChemSeal™	C	1/4"-28 UNF/threaded connection	No

Needle Point Styles

Hamilton offers several different needle point styles depending on the intended application. For most syringes and needles, the standard length is set to 51 mm. Customization of the length, gauge, and point style is possible to suit almost any application.

ID	Point Style	Description	Application	Gauges
2		10 – 12° sharp, beveled, curved non-coring	Gas chromatography, septum piercing	33 – 10 ga
3		Blunt, electro-polished	High performance liquid chromatography (HPLC) injection, thin-layer chromatography (TLC), general liquid handling, controlled animal injections	34 – 10 ga
3T		Blunt, electro-polished, coated with PTFE 19 mm from the tip	Thin-Layer Chromatography (TLC) applications	26s, 26, 22s, and 22 ga
4		Sharp 10 – 12° beveled needle; other angles available upon request	Life science/animal injections	34 – 10 ga
5		Conical with side port for penetration without coring	Headspace, applications prone to needle clogging, causes minimal septum damage	26 – 10 ga
AS		Conical, non-coring designed to withstand multiple injections	Autosampler injection, pre-pierced septa	26 – 10 ga





GENERAL SYRINGES

General Syringes

This section contains our most popular syringes, grouped by their physical characteristics and construction. Syringes are first organized by type; either Microliter or Gastight, then by series, termination, volume, point style, gauge, and finally, length.

The page numbers listed to the right mark the beginning of the part numbers available for each syringe series. For a detailed explanation of each syringe series refer to the Syringe 101 section on page 10.





Microliter™ Syringe Series

The result is a liquid tight seal with nearly frictionless movement. These syringes are ideal for organic samples that are not prone to precipitation, crystallization or bonding with glass.



Microliter Syringes

P. 16

Gastight® Syringe Series

Gastight syringes are ideal for dispensing both liquids and gases. They have a polymer plunger tip effectively which creates a leak-free seal. The polymer tip wipes the interior of the syringe barrel free of sample.



Gastight Syringes

P. 20

Calibrated Syringes

Simplify compliance by purchasing factory calibrated and serialized syringes.



Calibrated Syringes

P. 26

Digital Syringes

Eliminate the need for reading graduations and improve accuracy and precision with a factory calibrated Digital Syringe.



Digital Syringes

P. 27





Microliter Syringes

Microliter syringes are for use with liquids only. They incorporate hand-fitted stainless steel plungers with precision bored syringe barrels. The hand fitting process enables the tightest possible seal with a plunger movement that is virtually frictionless. The result is a syringe with minimal plunger wear and an almost unlimited useful life when maintained properly.

These syringes are ideal for homogeneous samples that are not prone to precipitation or bonding with glass. However, when using

heterogeneous solutions, the user must be diligent about cleaning the syringe after each use. Refer to page 77 for care and use recommendations.

In some cases, even diligent cleaning is not sufficient and the barrel will become soiled. The deposits on the glass will compromise the tight tolerance between the glass and the plunger resulting in a frozen plunger. Plungers for Microliter syringes cannot be interchanged or replaced if damaged. For heterogeneous solutions, a Gastight syringe is the best option.

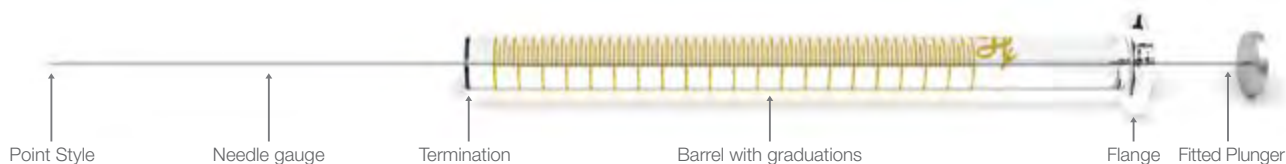

600 Series Syringes
2.5 μL to 5 μL



P. 17

700 Series Syringes
5 μL to 500 μL



P. 17

800 Series Syringes
5 μL to 250 μL



P. 18

7000 Series Syringes
0.5 μL to 5 μL



P. 19



600 Series Syringes

The 600 series syringes are a rugged, durable, and long lasting half stroke version of Hamilton's original 700 series syringes. They have a reinforced plunger which prevents plunger bending. Each plunger is individually fitted to the glass barrel and cannot be interchanged between syringes. This series of syringes is ideal for dispensing volumes from 0.25 μL up to 5 μL . Because of the shorter stroke length, the 600 series syringes can be used for one-handed applications.

Removable Needle Syringes



P/N	Volume	Gauge	Length	Point
87942	2.5 μL	22s ga	51 mm	3
7632-01	2.5 μL	NDL Sold Separately (Small RN)		
87943	5 μL	22s ga	51 mm	3
7633-01	5 μL	NDL Sold Separately (Small RN)		



700 Series Syringes

The 700 series syringe is the original hand-fitted Hamilton syringe. The stainless steel plunger is manufactured to fit the glass barrel with a tolerance less than three thousandths of a millimeter, resulting in unsurpassed syringe life. This series of syringes is ideal for dispensing volumes from 0.5 μL up to 500 μL . A variety of different terminations and needle options are available.

Cemented Needle Syringes



P/N	Volume	Gauge	Length	Point	Digital
87900	5 μL	26s ga	51 mm	2	Y
87919	5 μL	26s ga	51 mm	3	N
87908	5 μL	33 - 18 ga	10 - 304 mm	2, 3, 4, 5, AS	N
80300	10 μL	26s ga	51 mm	2	Y
80339	10 μL	26s ga	51 mm	5	N
80350	10 μL	26s ga	70 mm	2	N
80365	10 μL	22s ga	51 mm	3	Y
80366	10 μL - 6 pk	26s ga	51 mm	2	N
80383	10 μL	26s ga	51 mm	3	Y
80384	10 μL	26s ga	76 mm	2	N
80308	10 μL	33 - 18 ga	10 - 304 mm	2,3,4,5, AS	N
80400	25 μL	22s ga	51 mm	2	Y
80439	25 μL	22s ga	51 mm	5	N
80465	25 μL	22s ga	51 mm	3	Y
80408	25 μL	33 - 18 ga	10 - 304 mm	2,3,4,5, AS	N
80500	50 μL	22s ga	51 mm	2	Y
80521	50 μL	22 ga	51 mm	3	N
80539	50 μL	22s ga	51 mm	5	N
80565	50 μL	22s ga	51 mm	3	Y
80508	50 μL	33 - 18 ga	10 - 304 mm	2,3,4,5, AS	N



Point Styles

Point 2  Point 3  Point 4  Point 5  Point AS 

700 Series Syringes (Cont.)

Cemented Needle Syringes (Cont.)

P/N	Volume	Gauge	Length	Point	Digital
80600	100 µL	22s ga	51 mm	2	Y
80621	100 µL	22 ga	51 mm	3	N
80639	100 µL	22s ga	51 mm	5	N
80665	100 µL	22s ga	51 mm	3	Y
80608	100 µL	33 – 18 ga	10 – 304 mm	2,3,4,5, AS	N
80700	250 µL	22s ga	51 mm	2	Y
80739	250 µL	22 ga	51 mm	5	N
80765	250 µL	22 ga	51 mm	3	Y
80708	250 µL	33 – 18 ga	10 – 304 mm	2,3,4,5, AS	N
80800	500 µL	22 ga	51 mm	2	Y
80839	500 µL	22 ga	51 mm	5	N
80865	500 µL	22 ga	51 mm	3	Y
80808	500 µL	33 – 18 ga	10 – 304 mm	2,3,4,5, AS	N

Luer Tip Syringes



P/N	Volume	Needle Hub	Digital
80301	10 µL	Kel-F Hub	N
80401	25 µL	Kel-F Hub	N
80501	50 µL	Kel-F Hub	N
80601	100 µL	Kel-F Hub	N
80701	250 µL	Kel-F Hub	N
80801	500 µL	Kel-F Hub	N

Removable Needle Syringes



P/N	Volume	Gauge	Length	Point	Digital
87930	5 µL	26s ga	51 mm	2	Y
87931	5 µL	32 ga	51 mm	3	N
7634-01	5 µL	NDL Sold Separately (Small RN)			N
80330	10 µL	26s ga	51 mm	2	Y
80336	10 µL – 6 pk	26s ga	51 mm	2	N
80314	10 µL	32 ga	51 mm	3	N
7635-01	10 µL	NDL Sold Separately (Small RN)			N
80430	25 µL	22s ga	51 mm	2	Y
7636-01	25 µL	NDL Sold Separately (Small RN)			N
80530	50 µL	22s ga	51 mm	2	Y
7637-01	50 µL	NDL Sold Separately (Small RN)			N
80630	100 µL	22s ga	51 mm	2	Y
7638-01	100 µL	NDL Sold Separately (Small RN)			N
80730	250 µL	22s ga	51 mm	2	Y
7639-01	250 µL	NDL Sold Separately (Large RN)			N
80830	500 µL	22 ga	51 mm	2	Y
7640-01	500 µL	NDL Sold Separately (Large RN)			N

800 Series Syringes

The 800 series syringes are the reinforced plunger version of the 700 series syringes. Attached to the flange of the syringe is a blue syringe holder. The syringe holder provides an area to hold the syringe that prevents heat transfer, dispense inaccuracies, and plunger blow outs. Additionally, it provides support

to small volume plungers that are prone to bending during injection. This series of syringes is ideal for dispensing volumes from 0.5 µL up to 250 µL.



800 Series Syringes (Cont.)

Cemented Needle Syringes



P/N	Volume	Gauge	Length	Point
84850	5 µL	26s ga	51 mm	2
84852	10 µL	26s ga	51 mm	2
84854	25 µL	22s ga	51 mm	2
84856	50 µL	22s ga	51 mm	2
84858	100 µL	22s ga	51 mm	2

Removable Needle Syringes

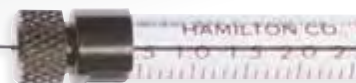

P/N	Volume	Gauge	Length	Point
84851	5 µL	26s ga	51 mm	2
7641-01	5 µL	NDL Sold Separately (Small RN)		
84853	10 µL	26s ga	51 mm	2
7642-01	10 µL	NDL Sold Separately (Small RN)		
84855	25 µL	22s ga	51 mm	2
7643-01	25 µL	NDL Sold Separately (Small RN)		
84857	50 µL	22s ga	51 mm	2
7644-01	50 µL	NDL Sold Separately (Small RN)		
84859	100 µL	22s ga	51 mm	2
7645-01	100 µL	NDL Sold Separately (Small RN)		
84861	250 µL	22s ga	51 mm	2
7646-01	250 µL	NDL Sold Separately (Large RN)		

7000 Series Syringes

The 7000 series syringes are modified Microliter syringes with a plunger-in-needle design. The 7000 series is the only zero dead volume syringe available. The fine gauge tungsten plunger wire extends to the tip of the needle, ensuring that all solvent is expelled dispensing volumes from 0.05 µL up to 5 µL.



Knurled Hub Syringes



P/N	Volume	Gauge	Length	Point	Digital
86259	0.5 µL	25 ga	70 mm	2	Y
86250	0.5 µL	25 ga	70 mm	3	Y
86257	0.5 µL	32 ga	100 mm	3	N
80135	1 µL	25 ga	70 mm	2	Y
86211	1 µL	22 ga	70 mm	2	Y
80100	1 µL	25 ga	70 mm	3	Y
86200	1 µL	22 ga	70 mm	3	Y
80108	1 µL	25 ga	48 – 127 mm	2, 3, or 4	N
88411	2 µL	25 ga	70 mm	2	Y
88511	2 µL	23 ga	70 mm	2	Y
88400	2 µL	25 ga	70 mm	3	Y
88500	2 µL	23 ga	70 mm	3	Y
88011	5 µL	24 ga	70 mm	2	Y
88000	5 µL	24 ga	70 mm	3	Y





Gastight Syringes

Gastight syringes are ideal for dispensing both liquids and gases. They have a precision-machined PTFE plunger tip which creates a leak-free seal. With the tight fit, the tip wipes the interior of the syringe barrel free of sample. This feature is particularly useful with heterogeneous samples as it reduces the chance that deposits will build up and cause the plunger to freeze.

The fluid path for all Gastight syringes is designed to be as chemically inert as possible. The liquid contact is borosilicate glass, PTFE, and stainless steel for all syringes except the Super Syringes which use acrylic and Buna-N in the barrel and plunger disc.

Polymer tip creates a leak-free seal for both liquids and gases



1700 Series Syringes
10 μ L to 500 μ L

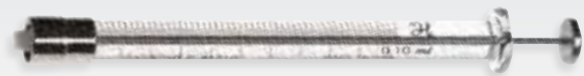

P. 21

1800 Series Syringes
10 μ L to 250 μ L



P. 23

1000 Series Syringes
1 mL to 100 mL



P. 24

Super Syringes
500 mL to 2 L



P. 25



1700 Series Syringes

The 1700 series syringes are the Gastight version of the original 700 series syringes. This series of syringes is ideal for dispensing volumes from 1 µL up to 500 µL. A variety of different terminations and needle options are available in this series.



Cemented Needle Syringes



P/N	Volume	Gauge	Length	Point	Digital
80000	10 µL	26s ga	51 mm	2	Y
80075	10 µL	26s ga	51 mm	3	Y
80085	10 µL	26 ga	51 mm	3	N
80039	10 µL	26s ga	51 mm	5	N
80008	10 µL	33 – 18 ga	10 – 304 mm	2, 3, 4, 5, AS	N
80200	25 µL	22s ga	51 mm	2	Y
80275	25 µL	22s ga	51 mm	3	Y
80285	25 µL	22 ga	51 mm	3	N
80239	25 µL	22s ga	51 mm	5	N
80208	25 µL	33 – 18 ga	10 – 304 mm	2, 3, 4, 5, AS	N
80900	50 µL	22s ga	51 mm	2	Y
80975	50 µL	22s ga	51 mm	3	Y
80985	50 µL	22 ga	51 mm	3	N
80939	50 µL	22s ga	51 mm	5	N
80908	50 µL	33 – 18 ga	10 – 304 mm	2, 3, 4, 5, AS	N
81000	100 µL	22s ga	51 mm	2	Y
81075	100 µL	22s ga	51 mm	3	Y
81085	100 µL	22 ga	51 mm	3	N
81039	100 µL	22s ga	51 mm	5	N
81008	100 µL	33 – 18 ga	10 – 304 mm	2, 3, 4, 5, AS	N
81100	250 µL	22s ga	51 mm	2	Y
81175	250 µL	22s ga	51 mm	3	Y
81185	250 µL	22 ga	51 mm	3	N
81139	250 µL	22s ga	51 mm	5	N
81108	250 µL	33 – 18 ga	10 – 304 mm	2, 3, 4, 5, AS	N
81217	500 µL	22 ga	51 mm	2	Y
81216	500 µL	22 ga	51 mm	3	N
81243	500 µL	22 ga	51 mm	5	N
81214	500 µL	33 – 18 ga	10 – 304 mm	2, 3, 4, 5, AS	N

Removable Needle Syringes



P/N	Volume	Gauge	Length	Point	Digital
80030	10 µL	26s ga	51 mm	2	Y
80065	10 µL	22s ga	51 mm	3	Y
80014	10 µL	32 ga	51 mm	3	N
7653-01	10 µL	NDL Sold Separately (Small RN)			N
80230	25 µL	22s ga	51 mm	2	Y
80265	25 µL	22s ga	51 mm	3	N
7654-01	25 µL	NDL Sold Separately (Small RN)			N
80930	50 µL	22s ga	51 mm	2	Y
80965	50 µL	22s ga	51 mm	3	N
7655-01	50 µL	NDL Sold Separately (Small RN)			N
81030	100 µL	22s ga	51 mm	2	Y
81065	100 µL	22s ga	51 mm	3	N
7656-01	100 µL	NDL Sold Separately (Small RN)			N
81130	250 µL	22s ga	51 mm	2	Y
81165	250 µL	22 ga	51 mm	3	N
7657-01	250 µL	NDL Sold Separately (Large RN)			N
81230	500 µL	22 ga	51 mm	2	Y
81265	500 µL	22 ga	51 mm	3	N
7658-01	500 µL	NDL Sold Separately (Large RN)			N



Point Styles





1700 Series Syringes (Cont.)

Luer Tip Syringes



P/N	Volume	Needle Hub	Digital
80001	10 µL	Kel-F Hub	N
80201	25 µL	Kel-F Hub	N
80901	50 µL	Kel-F Hub	Y
81001	100 µL	Kel-F Hub	N
81101	250 µL	Kel-F Hub	N
81201	500 µL	Kel-F Hub	N

Luer Lock Syringes



P/N	Volume	Needle Hub	Plunger Stop
80222	25 µL	Metal or Kel-F Hub	Yes
80920	50 µL	Metal or Kel-F Hub	No
80922	50 µL	Metal or Kel-F Hub	Yes
81020	100 µL	Metal or Kel-F Hub	No
81022	100 µL	Metal or Kel-F Hub	Yes
81120	250 µL	Metal or Kel-F Hub	No
81122	250 µL	Metal or Kel-F Hub	Yes
81220	500 µL	Metal or Kel-F Hub	No
81222	500 µL	Metal or Kel-F Hub	Yes

ChemSeal Syringes



P/N	Volume	Needle Hub	Plunger Stop
80062	10 µL	No Needle Available	Yes
80262	25 µL	No Needle Available	Yes
80962	50 µL	No Needle Available	Yes
81062	100 µL	No Needle Available	Yes
81060	100 µL	No Needle Available	No
81162	250 µL	No Needle Available	Yes
81160	250 µL	No Needle Available	No
81262	500 µL	No Needle Available	Yes
81260	500 µL	No Needle Available	No

Plunger Stop

For syringes 1 mL and smaller, the Plunger Stop replaces the standard dome button. The stop has a #6-32 threaded hole in the back for connecting to a syringe pump and is adjusted to protect the plunger tip from damage by hitting the syringe flange before the plunger tip bottoms out. Syringes larger than 1 mL come standard with a #6-32 threaded hole and do not require a plunger stop.

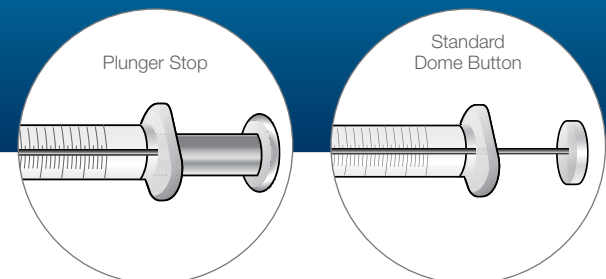

1800 Series Syringes

The 1800 series syringes are the reinforced plunger version of the 1700 series syringes. Attached to the flange of the syringe is a blue syringe holder. The syringe holder provides an area to hold the syringe that prevents heat transfer, dispense inaccuracies, and plunger blow outs. Additionally it provides support to small volume plungers that are prone to bending during injection. This series of syringes is ideal for dispensing volumes from 1 μL up to 250 μL .

Cemented Needle Syringes



P/N	Volume	Gauge	Length	Point
84875	10 μL	26s ga	51 mm	2
84878	25 μL	22s ga	51 mm	2
84881	50 μL	22s ga	51 mm	2
84884	100 μL	22s ga	51 mm	2
84887	250 μL	22s ga	51 mm	2

Removable Needle Syringes



P/N	Volume	Gauge	Length	Point
84877	10 μL	26s ga	51 mm	2
7659-01	10 μL	NDL Sold Separately (Small RN)		
84880	25 μL	22s ga	51 mm	2
7660-01	25 μL	NDL Sold Separately (Small RN)		
84883	50 μL	22s ga	51 mm	2
7661-01	50 μL	NDL Sold Separately (Small RN)		
84886	100 μL	22s ga	51 mm	2
7662-01	100 μL	NDL Sold Separately (Small RN)		
84889	250 μL	22s ga	51 mm	2
7663-01	250 μL	NDL Sold Separately (Large RN)		



Point Styles

Point 2  Point 3  Point 4  Point 5  Point AS 



1000 Series Syringes

The 1000 series syringes are a mid-volume Gastight syringe. This series of syringes is ideal for dispensing volumes from 100 µL up to 100 mL. A variety of different terminations and needle options are available in this versatile syringe series.



Luer Tip Cemented Needle Syringes



P/N	Volume	Gauge	Length	Point
81317	1 mL	22 ga	51 mm	2
81316	1 mL	22 ga	51 mm	3
81343	1 mL	22 ga	51 mm	5
81314	1 mL	33 – 18 ga	10 – 304 mm	2,3,4,5, AS
81417	2.5 mL	22 ga	51 mm	2
81416	2.5 mL	22 ga	51 mm	3
81443	2.5 mL	22 ga	51 mm	5
81414	2.5 mL	33 – 18 ga	10 – 304 mm	2,3,4,5, AS
81517	5 mL	22 ga	51 mm	2
81516	5 mL	22 ga	51 mm	3
81543	5 mL	22 ga	51 mm	5
81514	5 mL	33 – 18 ga	10 – 304 mm	2,3,4,5, AS
81617	10 mL	22 ga	51 mm	2
81616	10 mL	22 ga	51 mm	3
81643	10 mL	22 ga	51 mm	5
81614	10 mL	33 – 18 ga	10 – 304 mm	2,3,4,5, AS

Removable Needle Syringes



P/N	Volume	Gauge	Length	Point
81330	1 mL	22 ga	51 mm	2
81365	1 mL	22 ga	51 mm	3
7649-01	1 mL	NDL Sold Separately (Large RN)		
81430	2.5 mL	22 ga	51 mm	2
7650-01	2.5 mL	NDL Sold Separately (Large RN)		
81530	5 mL	22 ga	51 mm	2
7651-01	5 mL	NDL Sold Separately (Large RN)		
81630	10 mL	22 ga	51 mm	2
7652-01	10 mL	NDL Sold Separately (Large RN)		



Point Styles



1000 Series Syringes (Cont.)

Luer Tip Syringes



P/N	Volume	Needle Hub
81301	1 mL	Kel-F Hub
81401	2.5 mL	Kel-F Hub
81501	5 mL	Kel-F Hub
81601	10 mL	Kel-F Hub

ChemSeal Syringes



P/N	Volume	Needle Hub
81360	1 mL	No Needle Available
81460	2.5 mL	No Needle Available
81560	5 mL	No Needle Available
81660	10 mL	No Needle Available

Luer Lock Syringes



P/N	Volume	Needle Hub	With Flange
81320	1 mL	Metal or Kel-F Hub	Yes
81420	2.5 mL	Metal or Kel-F Hub	Yes
81520	5 mL	Metal or Kel-F Hub	Yes
81620	10 mL	Metal or Kel-F Hub	Yes
82520	25 mL	Metal or Kel-F Hub	Yes
82521	25 mL	Metal or Kel-F Hub	No
85020	50 mL	Metal or Kel-F Hub	Yes
85021	50 mL	Metal or Kel-F Hub	No
86020	100 mL	Metal or Kel-F Hub	Yes

Syringe Without Flange

The flange on a 25 mL and 50 mL syringe can interfere with mounting the syringe into a syringe pump. For these cases the syringes are available without a flange.

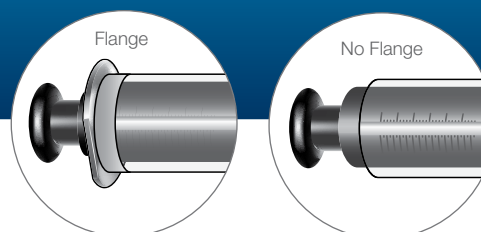

Super Syringes

The Hamilton Super Syringe is a large volume Gastight syringe. These syringes are ideal for dispensing volumes from 50 mL up to 2 L. Super Syringes are the only Hamilton syringes that are made with an acrylic barrel instead of glass.

Super Syringes



P/N	Volume	Needle Hub
86311	500 mL	Metal or Kel-F Hub
86312	1 L	Metal or Kel-F Hub
86313	1.5 L	Metal or Kel-F Hub
86314	2 L	Metal or Kel-F Hub



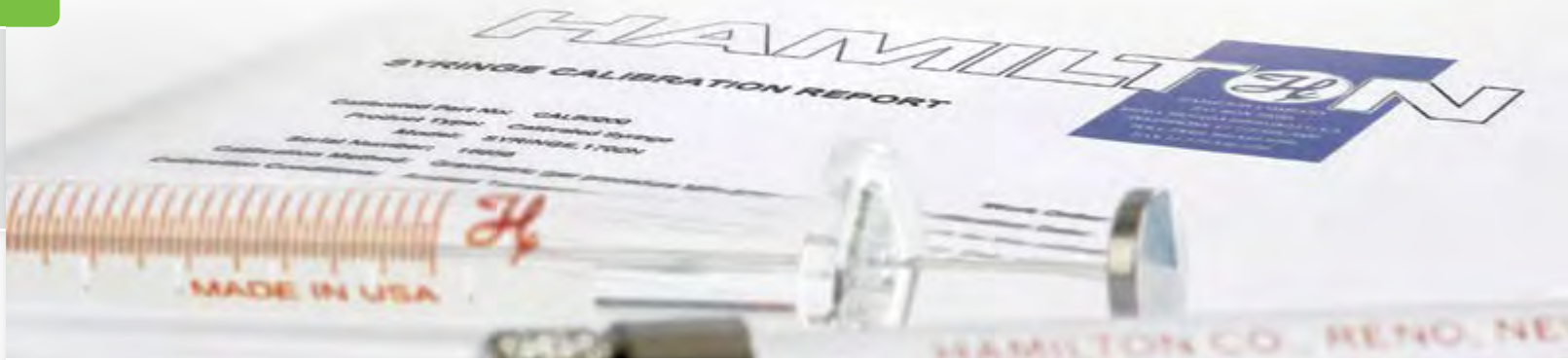

Calibrated Syringes

Hamilton Company offers a calibration service for precision Calibrated Syringes and Digital Syringes. A Certificate of Calibration is provided with the product and the procedure is performed with an unbroken chain of calibrations traceable to N.I.S.T. standards. Calibrated precision syringes are available only at the time of purchase. Most non-custom syringes

are available as calibrated; a complete listing of part numbers is available at hamiltoncompany.com. A calibrated syringe is ordered by adding the prefix "CAL" to the beginning of the syringe part number. For example, to order a calibrated 701N, 10 μ L syringe (part number 80300), part number CAL80300 should be requested.



Digital Syringes

Reading graduations can be a challenge. The Hamilton Digital Syringe eliminates parallax errors by providing a digital readout on its integrated LCD screen. An adjustable plunger-stop guarantees reproducible plunger placement. Easily achieve precision while dispensing volumes ranging from 50 nL up to 500 μ L. This syringe is operated by manually moving the plunger.

The Digital Syringe base unit is compatible with the 700 (page 17), 1700 (page 21), and 7000 (page 19) series syringes. Not all syringes are available as a Digital Syringe; check the syringe series page for availability. A Digital Syringe is ordered by adding the prefix “DS” to the beginning of the syringe part number. For example, to order a digital 701N, 10 μ L syringe (part number 80300), part number DS80300 should be requested.

Syringes Figure 1. Digital Syringe Features

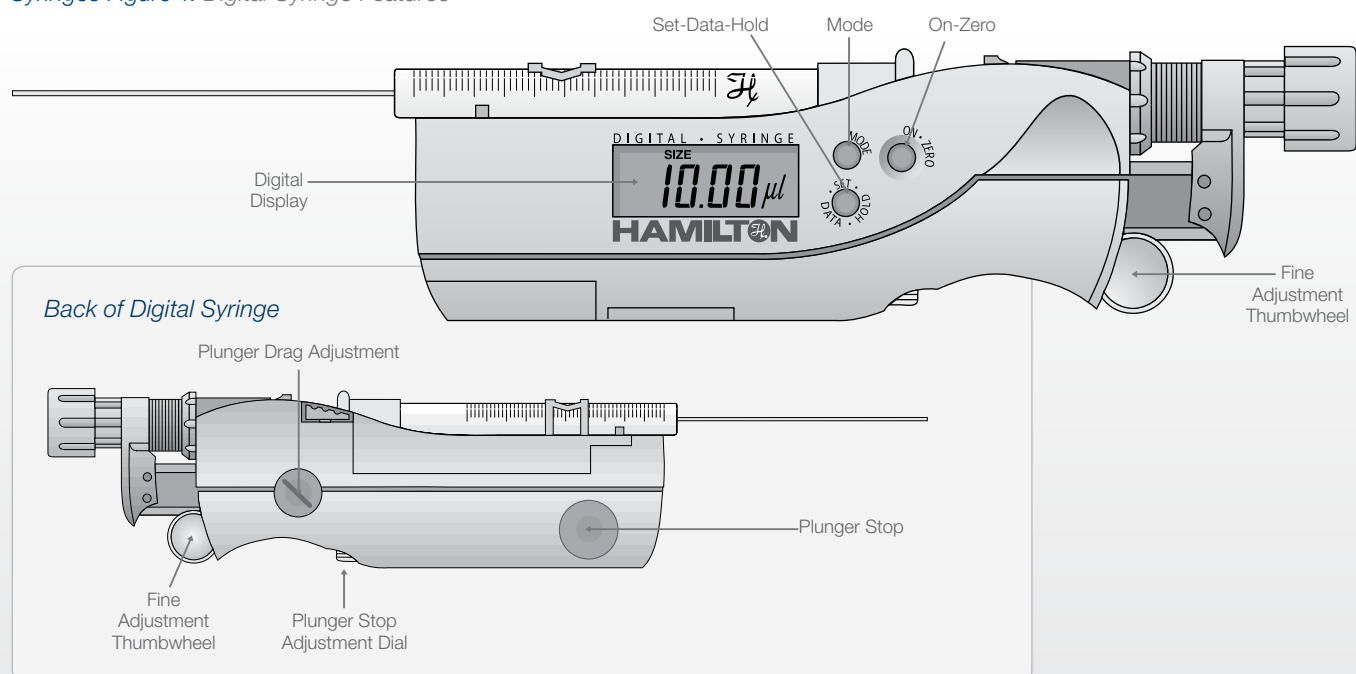



Chromatography and Analysis Syringes

In the late 1940's while working in the radiation lab at UC Berkeley, Clark Hamilton developed various devices, including glove box syringes for handling radioactive material. By the early 1960's Clark learned about additional liquid handling needs in the field of gas chromatography during a visit to Perkin-Elmer where he set out and developed the first micro syringe for accurate sample injection into GC instruments. In the early 1960's, two major gas chromatography companies,

F&M Scientific and Wilkens Aerograph, approached Hamilton Company to produce high accuracy syringes for the purpose of introducing exact, small volume injections into their GC systems. F&M Scientific and Wilkens Aerograph later became Agilent and Varian, and Hamilton continues to provide syringes for manual and automated injection into their instruments as well as many other GC and HPLC manufacturers.



Manual HPLC Syringes

HPLC syringes are equipped with a point style 3 needle to fit HPLC injection valve seats without damaging the rotor seal.

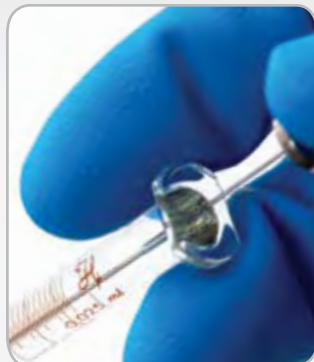

Manual HPLC Syringes

P. 30

HPLC Autosampler Syringes

A wide variety of syringes are offered to fit most HPLC autosamplers on the market.



HPLC Autosampler Syringes

P. 33

Manual GC Syringes

GC syringes are fitted with a point style 2 or point style AS needle to pierce injection port septa without damage.



Manual GC Syringes

P. 39

GC Autosampler Syringes

A wide selection of syringes fit most GC autosamplers in the lab.



GC Autosampler Syringes

P. 44

Thin-Layer Chromatography (TLC) Syringes

The needle points on Thin-Layer Chromatography (TLC) syringes are coated with a PTFE layer to reduce the surface tension between the needle and the liquid for reproducible sample spotting.



Thin-Layer Chromatography (TLC) Syringes

P. 54

Carbon Analyzer Syringes

This family of syringes is designed for water analysis in Total Organic Carbon (TOC) analyzers.



Carbon Analyzer Syringes

P. 55

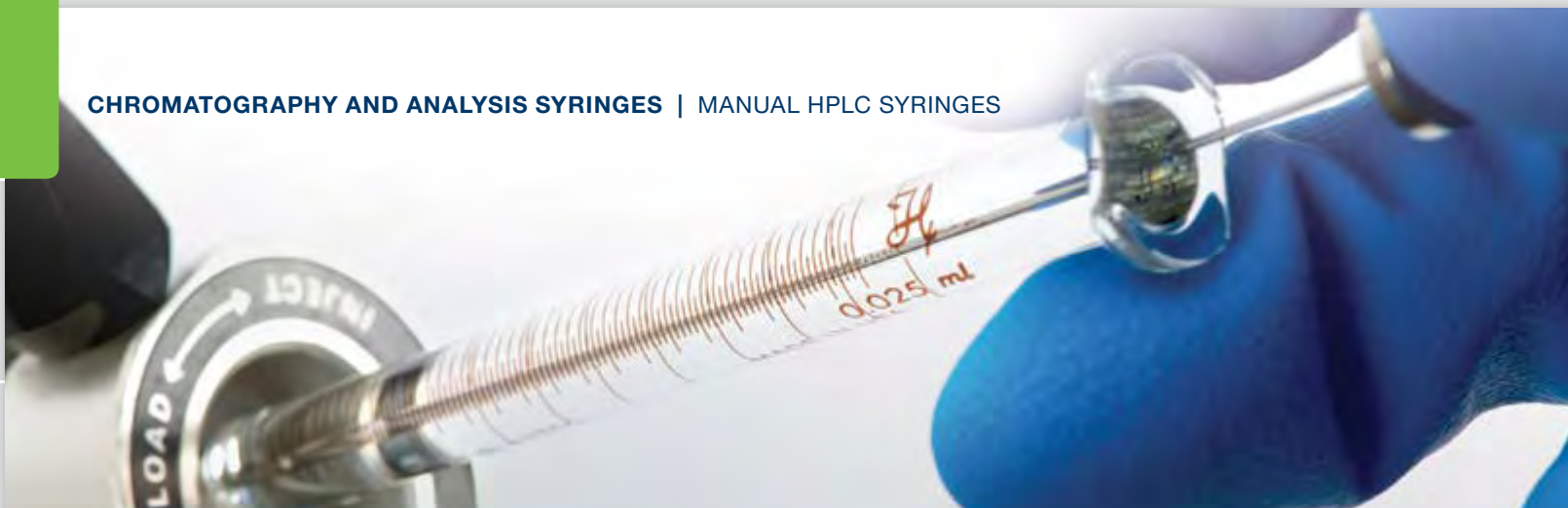

Manual HPLC Syringes

HPLC syringes are specifically designed for manual or automatic injection into high pressure ports. The needle is blunt and electro-polished to slide smoothly into the injection port, reducing the wear on critical seals. The selection of the appropriate syringe for HPLC applications takes the following three aspects into account: the type of injection valve, the sample properties,

and the injection volume. The volume of the syringe should be selected based on the volume and type of injection. In partial loop filling, the injection volume should not be greater than half of the loop capacity. In complete loop filling, where the loop size sets the injection volume, the syringe capacity should be greater than twice the loop volume.

Rheodyne, Valco, Beckman, and SSI Valves

2.5 μ L to 1 mL



P. 31

Constant Rate Syringes

20 μ L to 200 μ L



P. 31

Valco VISF-1 Injection Valves

25 μ L to 10 mL



P. 32

Waters Manual Syringes

10 μ L to 250 μ L



P. 32



Rheodyne, Valco, Beckman, and SSI Valves

Syringes for Rheodyne, Valco, Beckman, and SSI Valves. These syringes are available in Cemented Needle (N), Luer Tip Cemented Needle (LTN), and Removable Needle (RN) terminations. For more details on the terminations see page 12. The needles in this section are 51 mm in length and are point style 3.

Removable Needle (RN)



P/N	Volume	Series	Gauge
87942	2.5 µL	600	22s ga
87943	5 µL	600	22s ga
80065	10 µL	1700	22s ga
80265	25 µL	1700	22s ga
80965	50 µL	1700	22s ga
81065	100 µL	1700	22s ga
81165	250 µL	1700	22 ga
81265	500 µL	1700	22 ga
81365	1 mL	1000	22 ga

Cemented Needle (N)



P/N	Volume	Series	Gauge
80365	10 µL	700	22s ga
80465	25 µL	700	22s ga
80275	25 µL	1700	22s ga
80565	50 µL	700	22s ga
80975	50 µL	1700	22s ga
80985	50 µL	1700	22 ga
80665	100 µL	700	22s ga
81075	100 µL	1700	22s ga
81085	100 µL	1700	22 ga
80765	250 µL	700	22 ga
80865	500 µL	700	22 ga

Luer Tip Cemented Needle (LTN)



P/N	Volume	Series	Gauge
81175	250 µL	1700	22s ga
81185	250 µL	1700	22 ga
81216	500 µL	1700	22 ga

Constant Rate Syringes

The CR700 Constant Rate Syringes have preset volumes that can be dispensed at a constant flow rate. The volume is adjustable with a precisely adjustable micrometer screw. The adjusted volume can be fixed with a locking ring. Reproducible injection speed is obtained by means of a spring. The sample is delivered by pressing the push button. Constant Rate Syringe needles are 51 mm in length and point style 3.



P/N	Volume	Series	Gauge
84301	20 µL	1700	22s ga
84303	50 µL	1700	22 ga
84302	200 µL	1700	22 ga



Valco VISF-1 Injection Valves

Syringes for Valco VISF-1 Injection Valves. These syringes have the Removable Needle (RN) termination. For more details on the terminations see page 12. The needles in this section are 19 mm in length and are point style 3.



P/N	Volume	Series	Gauge	Replacement Needles
80231	25 µL	1700	22s ga	7787-01
80931	50 µL	1700	22s ga	7787-01
81031	100 µL	1700	22s ga	7787-01
81131	250 µL	1700	22s ga	7806-02
81231	500 µL	1700	22 ga	7787-02
81331	1 mL	1000	22 ga	7787-02
81431	2.5 mL	1000	22 ga	7787-02
81531	5 mL	1000	22 ga	7787-02
81631	10 mL	1000	22 ga	7787-02

Waters Manual Syringes

Gastight and Microliter series syringes come with a 25s gauge, 50 mm removable needle to work with the Waters U6K HPLC valve.

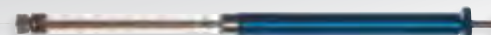

P/N	Volume	Series	Gauge	Replacement Needles
84815	10 µL	800	25s ga	8647-01
84816	25 µL	800	25s ga	8647-01
80238	25 µL	1700	25s ga	8647-01
84980	25 µL	1800	25s ga	8647-01
84817	50 µL	800	25s ga	8647-01
80938	50 µL	1700	25s ga	8647-01
84983	50 µL	1800	25s ga	8647-01
84818	100 µL	800	25s ga	8647-01
81038	100 µL	1700	25s ga	8647-01
84986	100 µL	1800	25s ga	8647-01
84819	250 µL	800	25s ga	8648-01
81138	250 µL	1700	25s ga	8648-01
84989	250 µL	1800	25s ga	8648-01

Part number 84891 is a kit that consists of a 10, 25, 50, 100, and 250 µL 800 series barrel/plunger assemblies, holder assembly, six-pack (25s/50 mm/3) small hub needles, and six-pack (25s/50 mm/3) large hub needles.

Part number 81610 is a 10 mL TLL syringe used for priming Waters syringes which can be used with 90149 Kel-F Hub Needles or 90049 Metal Hub Needles.



Point Styles

Point 2  Point 3  Point 4  Point 5  Point AS 



HPLC Autosampler Syringes

HPLC autosamplers enable the automatic introduction of samples into the sample loop as well as some sample preparation. Automatic injection has become very common, as it provides improved reproducibility and speed. Hamilton offers a wide range of HPLC autosampler syringes.

The features of the autosampler syringes are adapted for an exact fit to a specific autosampler.

Manufacturer	Model	For Syringes, See Model:	Page
Agilent	1290 Infinity LC Injector ProStar 410/420/430	PAL LC HTC, HTS Syringes Spark Holland Syringes	P. 34 P. 37
Antec	AS 100/110	Spark Holland Syringes	P. 37
Beckman Coulter	508	Spark Holland Syringes	P. 37
CTC/LEAP	A200S PAL LC HTC, HTS Syringes		P. 34 P. 34
Dionex	ASI-100 ESA Model 540/540 MT/542 Ultimate 3000	Spark Holland Syringes PAL LC HTC, HTS Syringes	P. 35 P. 37 P. 34
Grace Alltech	Model 580	Spark Holland Syringes	P. 37
Hitachi LaChrom	L-2200, 7200, 7250, 8800, 8900, AS 1000, 2000		P. 35
Kontron	360, 460, 465		P. 36
Perkin Elmer	Flexar FX-10, FX-15, Series 225 Series 220	Spark Holland Syringes	P. 37 P. 36
Shimadzu	SIL-6A SIL-10AF, SIL-10AP		P. 36 P. 36
Spark Holland	Midas, Triathlon, Endurance, Alias		P. 37
Thermo Finnigan	AS 100/300, AS 1000/3000/3500 SP 8780, SP 8875, SP 8880		P. 37 P. 38
Varian	ProStar 410/420/430 9100	Spark Holland Syringes	P. 37 P. 38
Waters	717 PLUS, WISP 2707 2777	Spark Holland Syringes PAL LC HTC, HTS Syringes	P. 38 P. 37 P. 34



CTC LEAP Syringes

A200S

Cemented Needle Syringes



P/N	Volume	Gauge	Length	Point
203560	10 µL	22s ga	51 mm	3
203566	100 µL	22s ga	51 mm	3

CTC PAL Syringes

PAL LC HTC, HTS

CTC PAL® autosamplers are one of the most popular sample injection systems for HPLC analyses. Customers rely on its ability to sample from many different vial and well types and on its ultimate platform flexibility. The syringe is at the heart of every injection that the LC PAL® system performs, and CTC chose Hamilton to provide this critical component.

This section has syringes for PAL LC instruments. This section also includes syringes for Agilent, Dionex, and Waters as these instruments are a private label for CTC.

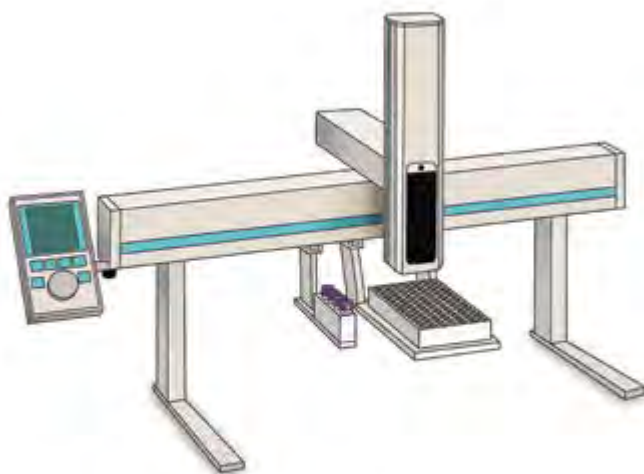

S-Line Syringes

S-Line syringes are the cost-effective choice for CTC PAL autosampler applications. It incorporates a precision-machined PTFE plunger tip which creates a leak-free seal. With the tight fit in the glass barrel, the tip wipes the interior of the syringe barrel free of sample, minimizing sample carryover.

C-Line Syringes

C-Line syringes incorporate several unique design features that ensure superior performance. The unique flange alignment design aids in installation and results in fewer bent needles while the plunger button can be adjusted to prevent plunger tip damage. An innovative direct attachment design of the needle to the barrel minimizes sample carryover.

X-Type Syringes

X-Type syringes have a near zero carryover and a long-lasting plunger tip to meet the requirements of sensitive, high-throughput life science applications. The syringe glass barrel is polished and coated for chemical inertness and enhanced lifetime. The needle is deactivated and coated to reduce sample adsorption.

S-Line Syringes



P/N	Volume	Barrel (O.D.)	Gauge	Point
67444-01	10 µL	6.6 mm	22s ga	3
67446-01	25 µL	7.9 mm	22s ga	3
67450-01	50 µL	6.6 mm	22 ga	3
67452-01	100 µL	6.6 mm	22s ga	3
67442-01	250 µL	7.9 mm	22 ga	3
67448-01	500 µL	7.9 mm	22 ga	3



CTC PAL Syringes (Cont.)

C-Line Syringes



P/N	Volume	Barrel (O.D.)	Gauge	Point
203073*	10 µL	6.6 mm	22s ga	3
203194	10 µL	6.6 mm	22s ga	3
203274	25 µL	6.6 mm	22s ga	3
203075	25 µL	7.9 mm	22s ga	3
203077	100 µL	6.6 mm	22s ga	3
203235	100 µL	6.6 mm	22 ga	3
203079	250 µL	7.9 mm	22 ga	3
203349	500 µL	7.9 mm	22 ga	3
203081**	1 mL	7.6 mm	22 ga	3
203083**	2.5 mL	9.65 mm	22 ga	3
203085**	5 mL	13.6 mm	22 ga	3

*This syringe is a Microliter Syringe.

**These syringes are a Luer Tip Cemented Needle (LTN) termination.

X-Type Syringes



P/N	Volume	Barrel (O.D.)	Gauge	Point
204475	25 µL	7.9 mm	22s ga	3
204379	50 µL	7.9 mm	22s ga	3
204452	100 µL	6.6 mm	22s ga	3
204400	100 µL	6.6 mm	22 ga	3
202668*	100 µL	6.6 mm		

* This part number is a Removable Needle (RN) termination.

Dionex Gina Syringes

ASI-100



Removable Needle (RN)



P/N	Volume
7654-01 (no needle included)	25 µL
7657-01 (no needle included)	250 µL

Hitachi LaChrom Syringes

L-2200, L-7200,
L-7250, L-8800,
L-8900, AS1000,
AS2000



Special Termination



P/N	Volume
0160310	500 µL



Point Styles

Point 2  Point 3  Point 4  Point 5  Point AS 

Kontron HPLC Syringes

360, 460, 465

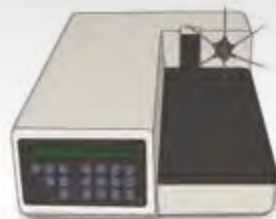

Accudil (AD)



P/N	Volume
201050	100 µL

Perkin Elmer Syringes

SERIES 220



ChemSeal (C)



P/N	Volume
80962	50 µL
81062	100 µL
81162	250 µL
81262	500 µL
81360	1 mL
81460	2.5 mL

Shimadzu Syringes

SIL-6A



Removable Needle (RN)



P/N	Volume
7656-01 (no needle included)	100 µL

Shimadzu Syringes

SIL-10AF,
SIL-10AP

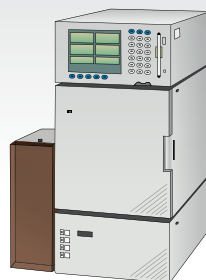

ChemSeal (C)



P/N	Volume
81260	500 µL
81460	2.5 mL

Spark Holland Syringes

This section has syringes for Spark Holland instruments. This section also includes syringes for Agilent, Antec, Beckman, Dionex, Grace Alltech, Perkin Elmer, Varian, and Waters as these instruments are a private label for Spark Holland.

ChemSeal (C)



P/N	Volume
62161-01	25 µL
54658-01	100 µL
54659-01	250 µL
54660-01	500 µL
54661-01	1 mL
54662-01	2.5 mL



Midas



Triathlon



Alias



Endurance

Thermo Finnigan Syringes

AS100/300,
AS1000/3000/3500



ChemSeal (C)



P/N	Volume
81162	250 µL
81262	500 µL
81360	1 mL
81460	2.5 mL



Thermo Finnigan Syringes

SP 8780, SP 8875,
SP 8880



ChemSeal (C)



P/N	Volume
202192	500 μ L
81460	2.5 mL

Varian Syringes

9100



ChemSeal (C)



P/N	Volume
0159902	100 μ L

Waters Syringes

717 PLUS, WISP



ChemSeal (C)



P/N	Volume
80020	25 μ L
80024	250 μ L





Manual GC Syringes

Hamilton provides a variety of syringes that are designed for use with manual GC injection ports. Our syringes are handmade with an unmatched attention to detail. The manufacturing process and quality assurance procedures ensure that every syringe we sell will provide superior

accuracy and precision as well as cycle life. The non-coring, point style 2 needles are ideal for penetrating septa while maximizing the life of the seal. Choose the sub category that is associated with your injection method to find the appropriate syringe for your application.

Standard Injection

0.5 μ L to 500 μ L



P. 40

Purge and Trap Syringes

5 mL and 25 mL



P. 42

SampleLock Syringes

50 μ L to 100 μ L



P. 42

On-Column Injection Syringes

0.5 μ L and 10 μ L



P. 43



Standard Injection

A split/splitless injector consists of a heated chamber with a glass liner into which the sample is injected through the septum. A microsyringe is used to inject the sample through a rubber septum into a flash vaporizer chamber at the head of the column. The sample vaporizes to form a mixture of carrier gas, vaporized solvent, and vaporized analytes. In the split mode, only a proportion of this mixture reaches the column, while most sample exits through the split outlet. This avoids overloading the column. In the splitless mode, the split vent is closed so that the vaporized analyte passes onto the column. This mode is more sensitive and adequate for trace analysis.

Common syringe features for split/splitless injection include:

- Microliter syringes for liquid samples and Gastight syringes for gas and liquid samples
- Common volume range from 0.5 μL to 50 μL
- Needle with point style 2 to pierce the rubber septum
- Needle length of 51 mmww to reach the middle of the glass liner. Splitless injection of small volumes may be performed with a 70 mm needle to deliver the sample close to the column entrance.

Syringes Figure 2. Illustration of a split/splitless injector

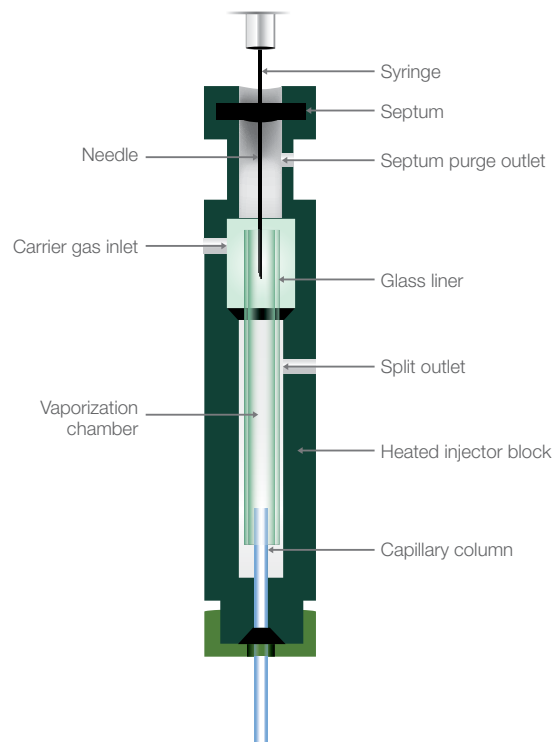

Standard Injection (Cont.)

Knurled Hub (KH)



P/N	Volume	Series	Gauge
86259	0.5 µL	7000	25 ga
86211	1 µL	7000	22 ga
80135	1 µL	7000	25 ga
88511	2 µL	7000	23 ga
88411	2 µL	7000	25 ga
88011	5 µL	7000	24 ga

Note: The needle length for these syringes is 70 mm.

Cemented Needle (N)

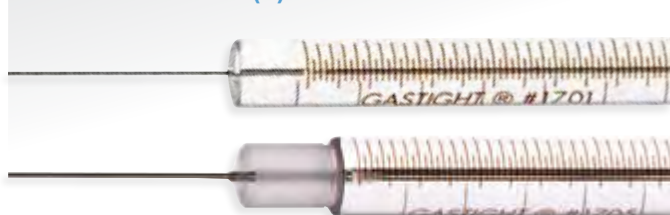

P/N	Volume	Series	Gauge
87900	5 µL	700	26s ga
84850	5 µL	800	26s ga
80300	10 µL	700	26s ga
80366	10 µL – 6 pk	700	26s ga
84852	10 µL	800	26s ga
80000	10 µL	1700	26s ga
84875	10 µL	1800	26s ga
80400	25 µL	700	22s ga
84854	25 µL	800	22s ga
80200	25 µL	1700	22s ga
84878	25 µL	1800	22s ga
80500	50 µL	700	22s ga
84856	50 µL	800	22s ga
80900	50 µL	1700	22s ga
84881	50 µL	1800	22s ga
80600	100 µL	700	22s ga
84858	100 µL	800	22s ga
81000	100 µL	1700	22s ga
84884	100 µL	1800	22s ga
80700	250 µL	700	22s ga
84887	250 µL	1800	22s ga
80800	500 µL	700	22 ga

Luer Tip Cemented Needle (LTN)



P/N	Volume	Series	Gauge
81100	250 µL	1700	22s ga
81217	500 µL	1700	22 ga

Removable Needle (RN)



P/N	Volume	Series	Gauge
87930	5 µL	700	26s ga
84851	5 µL	800	26s ga
80330	10 µL	700	26s ga
80336	10 µL – 6 pk	700	26s ga
84853	10 µL	800	26s ga
80030	10 µL	1700	26s ga
84877	10 µL	1800	26s ga
80430	25 µL	700	22s ga
84855	25 µL	800	22s ga
80230	25 µL	1700	22s ga
84880	25 µL	1800	22s ga
80530	50 µL	700	22s ga
84857	50 µL	800	22s ga
80930	50 µL	1700	22s ga
84883	50 µL	1800	22s ga
80630	100 µL	700	22s ga
84859	100 µL	800	22s ga
81030	100 µL	1700	22s ga
84886	100 µL	1800	22s ga
80730	250 µL	700	22s ga
84861	250 µL	800	22s ga
81130	250 µL	1700	22s ga
84889	250 µL	1800	22s ga
80830	500 µL	700	22 ga
81230	500 µL	1700	22 ga

Purge and Trap Syringes

These syringes are ideal for purge and trap applications because the plunger can be easily removed to load water samples into the syringe barrel. Internal standard or a surrogate spike can be added through the twist valve with a 10 μ L syringe. The sample syringe can also be connected directly to the purge and trap valve via the integral male luer fitting.

Hamilton 5 mL and 25 mL Purge and Trap syringes were designed for the analysis of drinking water samples according to EPA purge and trap concentration techniques (see EPA methods 502.1, 502.2, 503.1, 524.1, and 524.2).

Special Termination

P/N	Volume
81570	5 mL
82570	25 mL

Note: These syringes work with valve part number 86789.



SampleLock Syringes

The Hamilton SampleLock syringes allow the collection, storage, transportation, and analysis of liquid or gaseous samples without the danger of evaporative loss or environmental contamination.

Syringes are available in sizes ranging from 50 μ L to 100 mL. An easy-to-use twist valve and a positive rear stop on SampleLock prevents loss of sample and plunger blowout. Optional male luer and female luer lock adapter threads on the SampleLock valve making the syringes compatible with a multitude of connectors and fittings. These adapters may be found on page 73. The needles in this section are 51 mm in length and are point style 2.

SampleLock (SL)



P/N	Volume	Gauge
80956	50 μ L	22s ga
81056	100 μ L	22s ga
81156	250 μ L	22s ga
81256	500 μ L	22 ga
81356	1 mL	22 ga
81456	2.5 mL	22 ga
81556	5 mL	22 ga
81656	10 mL	22 ga
86326	25 mL	22 ga
86336	50 mL	22 ga
86346	100 mL	22 ga



Point Styles



On-Column Injection Syringes

On-column injection employs the direct introduction of the liquid sample into the column. This is very useful for the analysis of thermally unstable samples and avoids boiling point discrimination. On-column injection uses point style 3 syringes with the following features:

- Small outer diameter needles adjusted to the inner diameter of the column (0.17 mm needle for columns with 0.25 mm inner diameter, 32 gauge for columns with 0.32 mm inner diameter, and 26 gauge for columns with a 0.53 mm inner diameter)
- Longer needles tailored to pass through the injector and reach within the capillary column
- Point style 3 adapted to the typical septum of the on-column injector

Syringes Figure 3. Illustration of an On-Column Injector

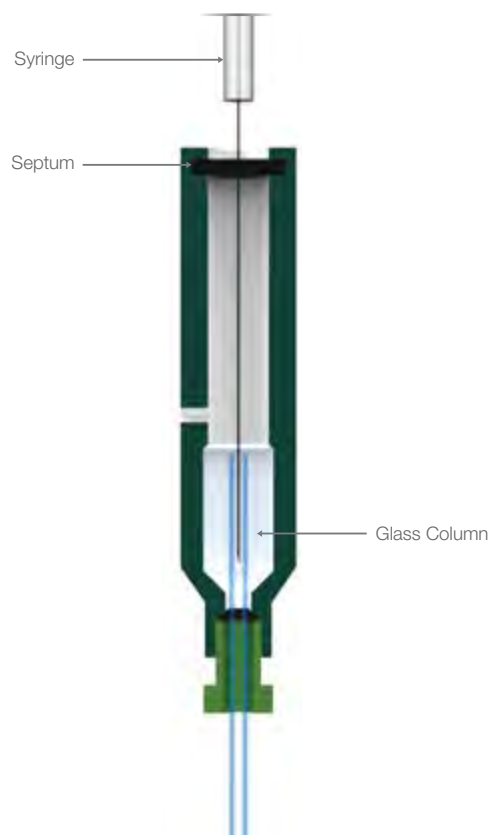

Knurled Hub (KH)



P/N	Volume	Series	Gauge	Length
86257	0.5 µL	7000	32 ga	100 mm

Cemented Needle (N)

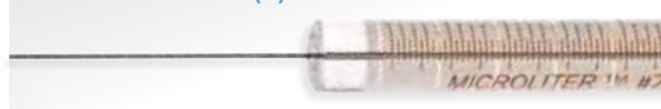

P/N	Volume	Series	Gauge	Length
80351	10 µL	700	32 ga	75 mm

Removable Needle (RN)

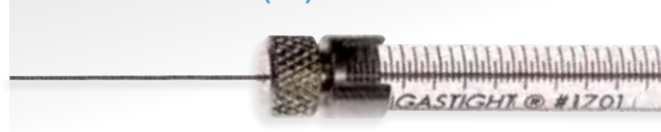

P/N	Volume	Series	Gauge	Length
80331	10 µL	700	0.17 mm	115 mm
80386*	10 µL	700	32 ga	125 mm
87402	10 µL	700	0.17 mm	100 mm
87404	10 µL	1700	0.17 mm	100 mm
87405	10 µL	1800	0.17 mm	100 mm

*This is a point style 2 needle.



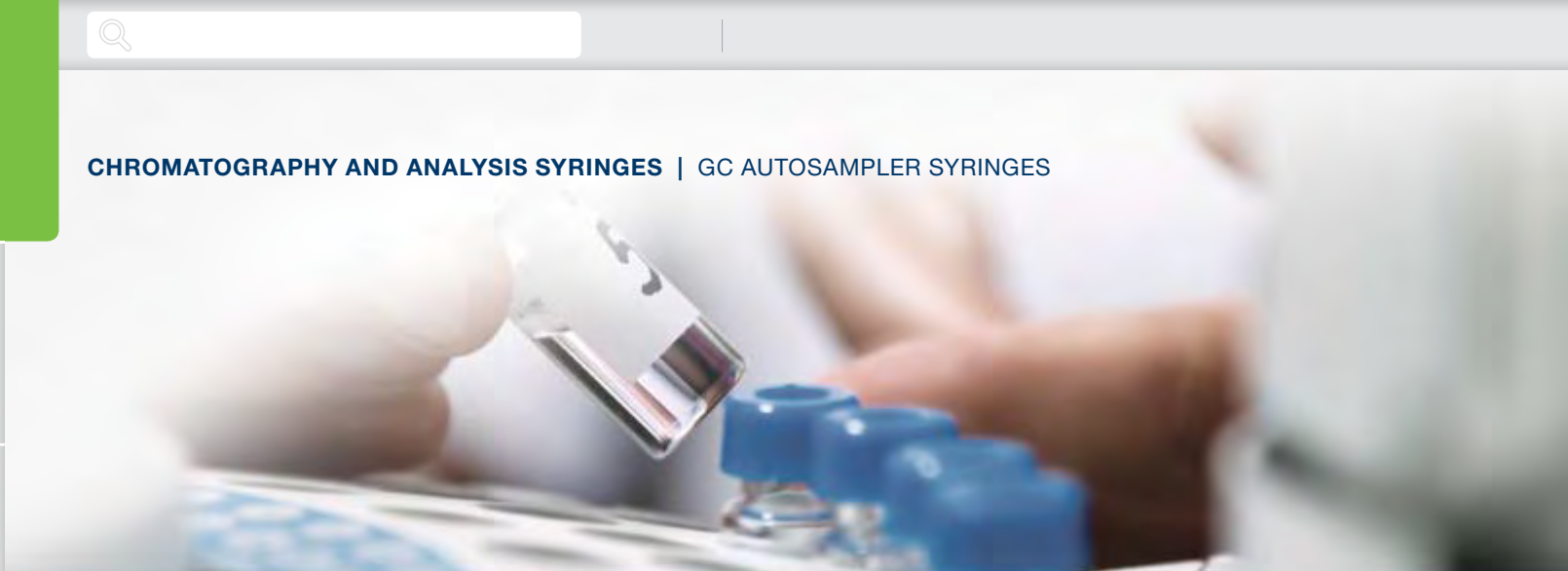

GC Autosampler Syringes

Autosamplers enable the automatic introduction of samples into the injector of the gas chromatograph (GC). Automatic injection has become very common as it improves reproducibility and speed.

Hamilton offers a wide range of autosampler syringes. The features of the autosampler syringes are adapted for an exact fit to a specific

autosampler. The point style AS (for autosampler) has been specifically designed to withstand repeated penetration through the GC septa. Syringes for headspace injection usually have a point style 5, which is ideal for large gas volume injection.

Manufacturer	Model	For Syringes, See Model:	Page
Agilent	7670, 7671, 7672 ALS 7673, 7683, 6850 ALS 7693A ALS		P. 45 P. 46 P. 48
Bruker Varian	8100, 8200 CP-8400/8410, CP-9010/9050 CP-9020/9025		P. 49 P. 49 P. 49
CTC / LEAP	CombiPAL (Headspace) CTC/LEAP PAL GC		P. 51 P. 50
Gerstel		CTC/LEAP PAL GC	P. 50
Perkin Elmer	AutoSystem Clarus 500 GC		P. 52 P. 52
Shimadzu	AOC-9 AOC-14, AOC-17, AOC-20 AOC-5000	CTC / LEAP CombiPAL (Headspace)	P. 52 P. 52 P. 51
Thermo Finnigan	AI/AS 3000 TriPlus AS 800/2000 HS 250/500/850 TriPlus	CTC/LEAP PAL GC	P. 53 P. 53 P. 53 P. 50



Agilent Syringes

7670, 7671, 7672 ALS

Hamilton maintains a large variety of replacement syringes for the most popular gas chromatography (GC) autosamplers, including the Agilent Automatic Liquid Sampler (ALS) instrument.

Hamilton has designed a series of syringes specifically for Agilent ALS autosamplers that meets the instruments' requirements for dimensional accuracy, needle length, needle gauge, needle tip, and overall lifetime. Every Agilent syringe produced by Hamilton undergoes quality control procedures that ensure they meet the strictest standards for accuracy, precision, and product life cycle.

Cemented Needle (N)



P/N	Volume	Gauge	Length	Point
87900	5 µL	26s ga	51 mm	2
80300	10 µL	26s ga	51 mm	2
80366	10 µL – 6 pk	26s ga	51 mm	2
80000*	10 µL	26s ga	51 mm	2

*This is a Gastight syringe.

Removable Needle (RN)



P/N	Volume	Gauge	Length	Point
80338	10 µL	26s ga	51 mm	2
80011*	10 µL	26s ga	51 mm	2

*This is a Gastight syringe.



Agilent Syringes

7673, 7683, 6850 ALS

The Agilent 7683 series automatic liquid sampler raises the standard for gas chromatography (GC) system performance and reliability. This is the automatic sampler to have for accuracy and ease of use, superior reproducibility with minimal rework, easy accommodation to changing needs, optimum injection flexibility, and enduring reliability.



Special Termination



P/N	Volume	Gauge	Length	Point
86274	0.5 µL	26 ga	43 mm	AS
86276	0.5 µL	23 ga	43 mm	AS
80175	1 µL	26 ga	43 mm	AS
80176	1 µL	23 ga	43 mm	AS

Cemented Needle (N)



P/N	Volume	Gauge	Length	Point
87992	5 µL	26s ga	43 mm	2
87988	5 µL	26s ga	43 mm	AS
87989	5 µL – 6 pk	26s ga	43 mm	AS
87991	5 µL	23s ga	43 mm	2
87987	5 µL	23s ga	43 mm	AS
87990	5 µL – 6 pk	23s ga	43 mm	AS
87993	5 µL	23s – 26s ga	43 mm	AS
87994	5 µL – 6 pk	23s – 26s ga	43 mm	AS
80399	10 µL	26s ga	43 mm	2
80388	10 µL	26s ga	43 mm	AS
80389	10 µL – 6 pk	26s ga	43 mm	AS
80398	10 µL	23s ga	43 mm	2
80387	10 µL	23s ga	43 mm	AS
80390	10 µL – 6 pk	23s ga	43 mm	AS
80080*	10 µL	23s ga	43 mm	AS
80094*	10 µL – 6 pk	23s ga	43 mm	AS
80393	10 µL	23s – 26s ga	43 mm	AS
80391	10 µL – 6 pk	23s – 26s ga	43 mm	AS
80079*	10 µL	23s – 26s ga	43 mm	AS
80096*	10 µL – 6 pk	23s – 26s ga	43 mm	AS

*These are Gastight syringes.

Removable Needle (RN)



P/N	Volume	Gauge	Length	Point
87958	5 µL	26s ga	43 mm	AS
87957	5 µL	23s ga	43 mm	AS
87959	5 µL	23s – 26s ga	43 mm	AS
80358	10 µL	26s ga	43 mm	AS
80088*	10 µL	26s ga	43 mm	AS
80357	10 µL	23s ga	43 mm	AS
80087*	10 µL	23s ga	43 mm	AS
80359	10 µL	23s – 26s ga	43 mm	AS
80089	10 µL	23s – 26s ga	43 mm	AS

*These are Gastight syringes.



Point Styles

Point 2 Point 3 Point 4 Point 5 Point AS

Needle Gauges

Choosing the Appropriate Agilent Needle

23s Gauge
Needle Syringes

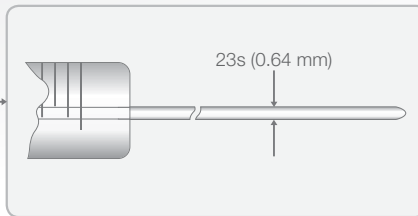

- Merlin Microseal™ septum and standard septum-equipped gas chromatographs
- Packed column injector ports
- Split/splitless injector ports

26s Gauge
Needle Syringes

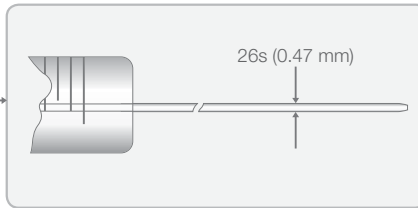

- On-Column injector ports
- Split/splitless injector ports

23s – 26s (Tapered) Gauge
Needle Syringes

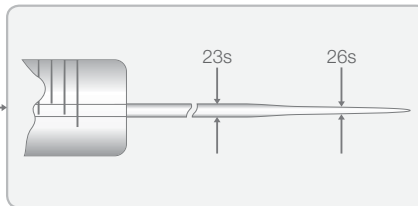

- Durability of a 23s gauge needle
- Ability of a 26s gauge needle to perform split/splitless and on-column injections

Agilent Syringes

7693A ALS

The 7693A builds on the proven Agilent Autosampler technologies that have worked reliably for customers in the past, including dual simultaneous injection and patented fast injection. The 7693A takes it one step further, adding basic sample preparation capabilities such as dilution, internal standard addition, heating, and more.

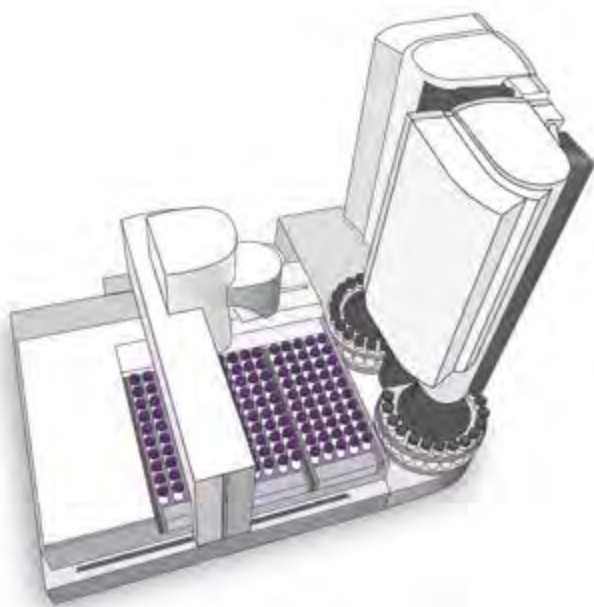

Special Termination



P/N	Volume	Gauge	Length	Point
86274	0.5 µL	26 ga	43 mm	AS
86276	0.5 µL	23 ga	43 mm	AS
80176	1 µL	23 ga	43 mm	AS

Cemented Needle (N)



P/N	Volume	Gauge	Length	Point
87988	5 µL	26s ga	43 mm	AS
87989	5 µL – 6 pk	26s ga	43 mm	AS
87987	5 µL	23s ga	43 mm	AS
87990	5 µL – 6 pk	23s ga	43 mm	AS
87993	5 µL	23s – 26s ga	43 mm	AS
87994	5 µL – 6 pk	23s – 26s ga	43 mm	AS
80388	10 µL	26s ga	43 mm	AS
80389	10 µL – 6 pk	26s ga	43 mm	AS
80387	10 µL	23s ga	43 mm	AS
80390	10 µL – 6 pk	23s ga	43 mm	AS
80080*	10 µL	23s ga	43 mm	AS
80094*	10 µL – 6 pk	23s ga	43 mm	AS
80393	10 µL	23s – 26s ga	43 mm	AS
80391	10 µL – 6 pk	23s – 26s ga	43 mm	AS
80079*	10 µL	23s – 26s ga	43 mm	AS
80096*	10 µL – 6 pk	23s – 26s ga	43 mm	AS

*These are Gastight syringes.

Removable Needle (RN)



P/N	Volume	Gauge	Length	Point
87958	5 µL	26s ga	43 mm	AS
87957	5 µL	23s ga	43 mm	AS
87959	5 µL	23s – 26s ga	43 mm	AS
80358	10 µL	26s ga	43 mm	AS
80088*	10 µL	26s ga	43 mm	AS
80357	10 µL	23s ga	43 mm	AS
80087*	10 µL	23s ga	43 mm	AS
80359	10 µL	23s – 26s ga	43 mm	AS
80089*	10 µL	23s – 26s ga	43 mm	AS

*These are Gastight syringes.



Bruker Varian Syringes

8100, 8200



Special Termination



P/N	Volume	Gauge	Length	Point
202880	10 µL	26s ga	50.5 mm	5

Note: Replacement needles for this syringe are part number 202903.

Bruker Varian Syringes

CP-8400/8410,
CP-9010/9050



Cemented Needle (N)



P/N	Volume	Gauge	Length	Point
80300	10 µL	26s ga	51 mm	2
80339	10 µL	26s ga	51 mm	5
80342	10 µL	23s ga	51 mm	AS
80330*	10 µL	26s ga	51 mm	2

**This is a Removable Needle (RN) syringe.*

Bruker Varian Syringes

CP-9020/9025

Luer Tip Cemented Needle (LTN)



P/N	Volume	Gauge	Length	Point
202660	2.5 mL	22 ga	56 mm	5



Point Styles

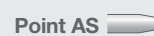

CTC / LEAP PAL GC Syringes

CTC PAL® autosamplers are one of the most popular sampling devices on the market today for GC and headspace analyses. Customers rely on its ability to sample from many different vial and well types and on its ultimate platform flexibility. The syringe is at the heart of every injection that the GC PAL® system performs, and CTC chose Hamilton to provide this critical component.

S-Line Syringes

S-Line syringes are the cost-effective choice for CTC PAL autosampler applications. S-Line syringes deliver great performance in everyday use for GC injections at an exceptional value. Fast injection speeds in GC analyses put considerable stress on syringe plungers and, as plungers wear the stresses increase, leading to broken syringes and unnecessary downtime and wasted money when samples cannot be analyzed.

C-Line Syringes

C-Line syringes incorporate several unique design features that ensure superior performance. The unique flange alignment design aids in installation and results in fewer bent needles while the plunger button can be adjusted to prevent plunger tip damage. An innovative direct attachment design of the needle to the barrel minimizes sample carryover.

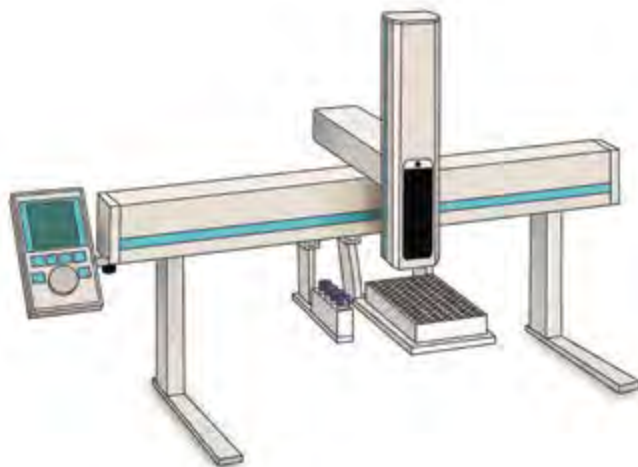

S-Line Syringe



P/N	Volume	Barrel (O.D.)	Gauge	Point
67436-01	5 µL	6.6 mm	26s ga	AS
67438-01	10 µL	6.6 mm	26s ga	AS
67440-01	10 µL	6.6 mm	23s ga	AS
67454-01*	10 µL	6.6 mm	23s ga	AS
67430-01*	25 µL	7.9 mm	23 ga	AS
67434-01*	100 µL	6.6 mm	23 ga	AS

*These are Gastight syringes.

C-Line Syringes



P/N	Volume	Barrel (O.D.)	Gauge	Point
203185	1.2 µL	6.6 mm	26 ga	AS
203189	5 µL	6.6 mm	26s ga	AS
203197	5 µL	6.6 mm	Custom	Custom
203205	10 µL	6.6 mm	26s ga	AS
203363	10 µL	6.6 mm	23s ga	2
203361	10 µL	6.6 mm	23s ga	AS
203362	10 µL	6.6 mm	23s – 26s ga	AS
203198	10 µL	6.6 mm	Custom	Custom
203206*	10 µL	6.6 mm	Custom	Custom
200740**	10 µL	6.6 mm	32 ga	4 at 45°
200742***	10 µL	6.6 mm	32 ga	4 at 45°
203074*	25 µL	6.6 mm	26s ga	AS
203043*	25 µL	7.9 mm	26s ga	AS
203209*	25 µL	6.6 mm	Custom	Custom
203076*	100 µL	6.6 mm	26s ga	AS
203226*	100 µL	6.6 mm	Custom	Custom
203078*	250 µL	7.9 mm	26 ga	AS
203219*	250 µL	7.9 mm	Custom	Custom
203080*	500 µL	7.9 mm	26 ga	AS
203225*	500 µL	7.9 mm	Custom	Custom

*These are Gastight syringes.

**This part number is 85 mm in length.

***This part number is 75 mm in length.

CTC / LEAP CombiPAL (Headspace) Syringes

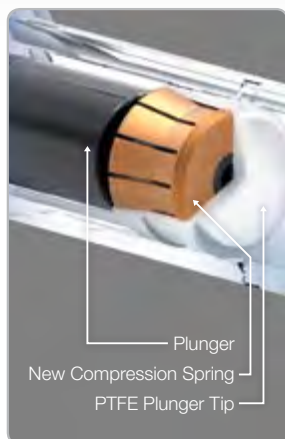

HD-Type and HDHT-Type Syringes

Modern GC headspace analysis requires injecting over large temperature ranges. Conventional headspace syringes on the market use a rubber O-ring sealed plunger which has a limited

sealing performance at high temperatures. This is due to varying thermal expansion between the different materials. The high dynamic HD-Type syringe and HDHT-Type syringes employ a unique spring in the plunger tip which compensates for the materials' different expansion coefficients, creating a superior seal over a larger temperature range, improving syringe lifetime.



HDHT-Type Syringes

A cement-free connection between the needle and the glass barrel make HDHT-Type syringes a perfect choice for applications where temperatures up to 200 °C will be used.

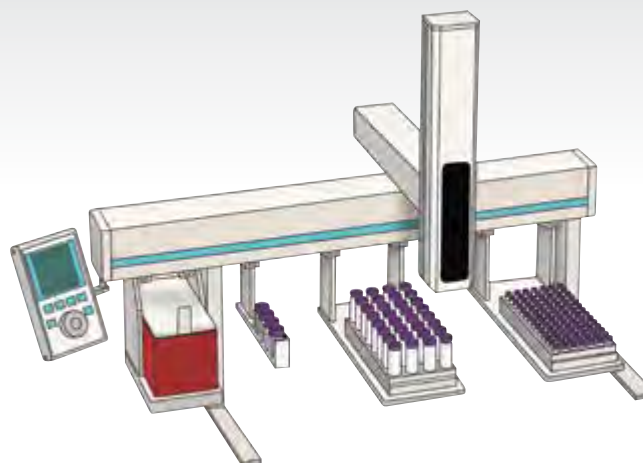

HD-Type Syringes (110 °C)



P/N	Volume	Gauge	Point
203141	1 mL	26 ga	5
203082	1 mL	23 ga	5
203181	2.5 mL	26 ga	5
203084	2.5 mL	23 ga	5
203182	5 mL	26 ga	5
203086	5 mL	23 ga	5

HDHT-Type Syringes (200 °C)



P/N	Volume	Gauge	Point
209682	1 mL	26 ga	5
209681	1 mL	23 ga	5
209684	2.5 mL	26 ga	5
209683	2.5 mL	23 ga	5
209686	5 mL	26 ga	5
209685	5 mL	23 ga	5



Perkin Elmer AutoSystem and Clarus Syringes

500 GC

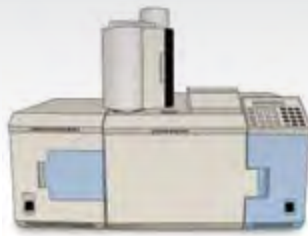

Special Termination



P/N	Volume	Gauge	Length	Point
88040	5 µL	0.47 mm	70 mm	3
88035	5 µL	0.63 mm	70 mm	3

Shimadzu Syringes

AOC-9

Removable Needle (RN)



P/N	Volume	Gauge	Length	Point
87930	5 µL	26s ga	51 mm	2
80330	10 µL	26s ga	51 mm	2

Shimadzu Syringes

AOC-14,
AOC-17,
AOC-20



Removable Needle (RN)

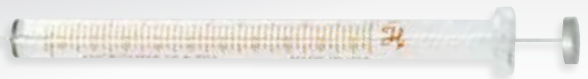

P/N	Volume	Gauge	Length	Point
202630	5 µL	22s ga	43 mm	2
202640	10 µL	22s ga	43 mm	2
202643*	10 µL	23s ga	43 mm	AS
93898-01**	10 µL	23s ga	43 mm	AS

*Cemented Needle termination with metal flange

**Cemented Needle termination with a glass flange



Point Styles

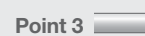



Thermo Finnigan Syringes

AI/AS 3000
TRIPLUS



Cemented Needle (N)



P/N	Volume	Gauge	Length	Point
204000	5 µL	26s ga	50 mm	2
204051	5 µL	26s ga	50 mm	AS
204001	10 µL	26s ga	50 mm	2
204052	10 µL	26s ga	50 mm	AS

Thermo Finnigan Syringes

AS 800/2000



Cemented Needle (N)



P/N	Volume	Gauge	Length	Point
80318	10 µL	26s ga	80 mm	AS

Thermo Finnigan Syringes

HS 250, 500, 850

Luer Tip Cemented Needle



P/N	Volume	Gauge	Length	Point
202660	2.5 mL	22 ga	56 mm	5



Thin-Layer Chromatography (TLC) Syringes

The first 19 mm of a Thin-Layer Chromatography needle is coated with PTFE. The coating reduces the surface tension between the needle and the liquid, making it ideal for reproducible sample

spotting. The TLC syringe is available as a cemented needle (SNTLC) or as a replacement needle to be installed into a standard removable needle (RN) syringe.

Cemented Needle (N)



P/N	Volume	Gauge	Length	Point
80050	10 µL	26s ga	51 mm	3T
80250	25 µL	22s ga	51 mm	3T
80950	50 µL	22 ga	51 mm	3T
81050	100 µL	22 ga	51 mm	3T

Removable Needle (RN)



P/N	Volume	Series	Needle
7653-01	10 µL	1700	8646-02
7654-01	25 µL	1700	8646-03
7655-01	50 µL	1700	8646-05
7656-01	100 µL	1700	8646-05
7657-01	250 µL	1700	8646-01
7658-01	500 µL	1700	8646-01
7649-01	1 mL	1000	8646-01
7650-01	2.5 mL	1000	8646-01
7651-01	5 mL	1000	8646-01
7652-01	10 mL	1000	8646-01





Carbon Analyzer Syringes

These syringes are used for water analysis with Total Organic Carbon (TOC) analyzers. TOC syringes feature a unique termination that has a male, luer tapered hub that is cemented on the syringe barrel.

This special termination is designed to fit precisely into the inlet of a TOC analyzer. The wetted parts are stainless steel and borosilicate glass. The plungers and barrels are not interchangeable or replaceable.

Special Termination



P/N	Volume	Gauge	Length	Point
80550	50 µL	24 ga	51 mm	3
80551	50 µL	26 ga	64 mm	3
80660	100 µL	24 ga	51 mm	3
80770	250 µL	24 ga	51 mm	3





Life Science Syringes

Hamilton Company offers a wide variety of syringes for life science applications. From gel-loading syringes to custom needles and specialized syringes for animal injections, Hamilton has a solution for many precision liquid handling applications.





Neuros Syringes

Designed specifically for lab animal neuroscience injections. Neuros precisely delivers sample to the target with minimal damage.



Neuros Syringes

P. 58

Syringes Connected to:

A variety of different connections are available for connecting small gauge needles, glass capillaries, and PEEK tubing to Hamilton small hub removable needle syringes.



Syringes Connected to:

P. 60

Specialty Syringes

Specialty syringes include Threaded Plunger Syringes, Gel-Loading Syringes, and Micro Pipetting Syringes



Specialty Syringes

P. 64





Neuros Syringes

Hamilton Neuros syringe technology provides unprecedented functionality for controlled animal injections. The Neuros accurately dispenses volumes between 50 nL and 100 µL through an ultrafine needle. Developed specifically for neuroscience applications, the Neuros enables the delivery of microvolumes to an exact location while minimizing injection site damage. Neuros syringes come with two types of protective needle sleeves. The sleeve with a blind stop is perfect for cannulated applications and ensures targeted

administration with an adjustable penetration depth. The version without a blind stop works best with stereotaxic holders. Both models provide an adjustable needle exposure of 0 to 20 mm.

- Needle rigidity improves insertion path accuracy
- Minimal tissue damage reduces injection variability
- Reduced sample loss saves money and materials
- A fine gauge needle creates smaller injection sites
- Compatibility with most infusion pumps and stereotaxic holders means an easy integration into existing processes

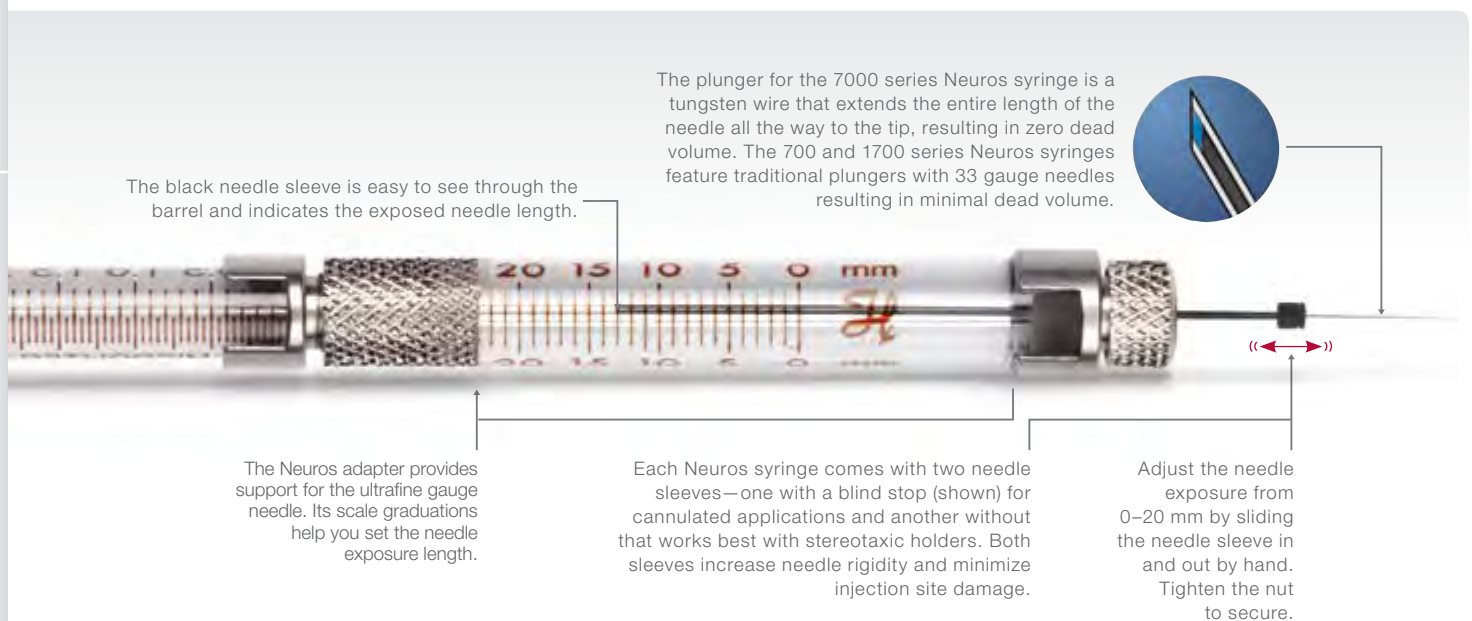

Neuros Syringe Assemblies

P/N	Volume	Gauge	Point	Series
65457-01	0.5 µL	32 ga	3	7000
65457-02	0.5 µL	32 ga	4	7000
65458-01	1.0 µL	32 ga	3	7000
65458-02	1.0 µL	32 ga	4	7000
65459-01	2.0 µL	30 ga	3	7000
65459-02	2.0 µL	30 ga	4	7000
65460-02	5 µL	33 ga	3	700
65460-03	5 µL	33 ga	4	700
65460-05	10 µL	33 ga	3	1700
65460-06	10 µL	33 ga	4	1700
65460-10	25 µL	33 ga	3	1700
65460-11	25 µL	33 ga	4	1700
65460-15	50 µL	33 ga	3	1700
65460-16	50 µL	33 ga	4	1700
65460-20	100 µL	33 ga	3	1700
65460-21	100 µL	33 ga	4	1700

Neuros Replacement Parts

P/N	Volume	Gauge	Point
65461-01	Needle 5 – 100 µL – 6pk	33 ga	3
65461-02	Needle 5 – 100 µL – 6pk	33 ga	4
65460-01	Adapter Kit for 5 – 100 µL RN syringes	33 ga	3
65460-04	Adapter Kit for 5 – 100 µL RN syringes	33 ga	4

No replacement parts are available for the 7000 Series Neuros Syringes.





Syringes Connected to:

Small Gauge Needles, Glass Micro Pipettes, PE Tubing, and PEEK Tubing

Life science applications often require connection of syringes to a variety of different needle and tubing options. The accessories in this section enable a robust and low dead volume connection to any RN syringe 100 μ L and smaller.

Adapters

Small Gauge Needle

PEEK Tubing

Glass Micro Pipette

PE Tubing

Syringe with Small RN Termination

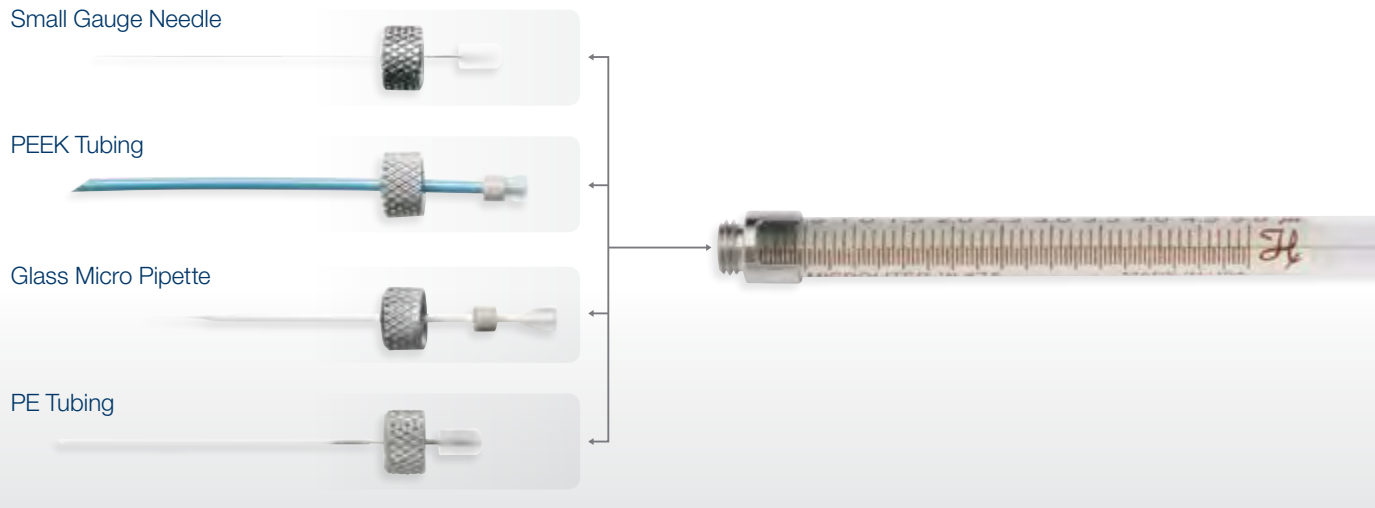

Priming Your Tubing

Connecting a small volume syringe to tubing adds dead volume and makes the system difficult to prime. In these cases remove the plunger and use the priming kit to load buffer or mineral oil through the back of the syringe. Visit page 63 for more information on Priming Kits.

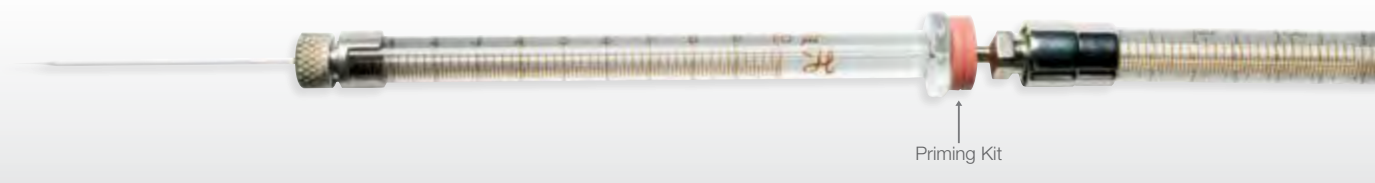



Removeable Needle Syringes Without Needle

These syringes have a robust, low dead volume connection that can be used with all the needle and tubing connectors in this section.



P/N	Volume	Series
7632-01	2.5 µL	600
7633-01	5 µL	600
7634-01	5 µL	700
7635-01	10 µL	700
7653-01	10 µL	1700
7636-01	25 µL	700
7654-01	25 µL	1700
7637-01	50 µL	700
7655-01	50 µL	1700
7638-01	100 µL	700
7656-01	100 µL	1700

Convert 7000 Series to Small RN Hub

For ultra-low dispense volumes the 7000 series syringes can be adapted to a removable needle termination using the adapters below.



Knurled Hub Syringes

P/N	Volume	Series
86250	0.5 µL	7000
80100	1.0 µL	7000
88400	2.0 µL	7000





Small Gauge Needles

Fine gauge needles are used for animal injections to limit tissue damage and sample loss. Removable needles have minimal dead volume and for this reason are recommended over a luer or luer lock connection. These needles are compatible with RN syringes 100 µL and smaller. At the time of ordering specify the desired length and point style.



Small Hub Removable Needles

P/N	Gauge	Length	Point
207434	34 ga	10, 13, 25, or 38 mm	3 or 4
7803-05	33 ga	10 – 304 mm	2, 3, or 4
7803-04	32 ga	10 – 304 mm	2, 3, or 4
7803-03	31 ga	10 – 304 mm	2, 3, or 4
7803-07	30 ga	10 – 304 mm	2, 3, or 4
7803-06	29 ga	10 – 304 mm	2, 3, or 4
7803-02	28 ga	10 – 304 mm	2, 3, or 4
7803-01	27 ga	10 – 304 mm	2, 3, or 4
7804-04	26s ga	10 – 304 mm	2, 3, or 4
7804-03	26 ga	10 – 304 mm	2, 3, or 4
7804-10	25s ga	10 – 304 mm	2, 3, or 4
7804-05	25 ga	10 – 304 mm	2, 3, or 4
7804-08	24 ga	10 – 304 mm	2, 3, or 4
7804-09	23s ga	10 – 304 mm	2, 3, or 4
7804-07	23 ga	10 – 304 mm	2, 3, or 4
7804-02	22s ga	10 – 304 mm	2, 3, or 4
7804-01	22 ga	10 – 304 mm	2, 3, or 4

Glass Micro Pipettes

Glass micro pipettes are widely used in neuroscience because the point can be pulled to an incredibly small diameter and maintain the rigidity to penetrate tissue. Additionally, the dispense orifice exits from the very tip of the needle so the wound track can be minimized.

The 1 mm RN compression fitting allows for quick connection to standard 1 mm capillary glass. Pull your own needle and attach it to an RN syringe without wax or glue.

1 mm Compression Fitting



P/N	Description
55750-01	RN Compression Fitting 1 mm

Hamilton does not offer 1 mm glass capillary tubing.

PE Tubing

Polyethylene (PE) tubing is frequently used for lab animal applications. Connect PE tubing to a syringe by pressing the tubing onto the tip of a needle. The table shows the needle gauge that is properly sized for a press fit with PE 10, PE 20, and PE 50 tubing.

Needle Gauges for PE Tubing

Tubing Size	Compatible Needle Gauge
PE 10	30 ga
PE 20	27 ga
PE 50	23 or 23s ga

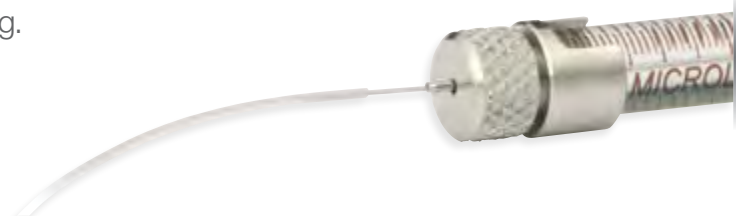

Point Styles



PEEK Tubing

Polyether ether ketone (PEEK) tubing is widely used in chromatography for its small dead volume, chemical biocompatibility, and high pressure rating. These features also make it ideal for lab animal applications. Use the compression fitting to connect any 1/16th inch (1.6 mm) outer diameter PEEK tubing to a 100 µL or smaller RN syringe.

PEEK Compression Fittings



Part Number	Description
55751-01	RN Compression Fitting 1/16 inch

Note: Hamilton does not sell PEEK tubing; it needs to be sourced through a third party.

Dual RN Coupler

Connect an RN needle to the end of PEEK tubing with the small RN to RN connector (P/N 55752-01).



Priming Kit

Connecting glass or plastic tubing to a syringe increases the dead volume and makes priming difficult. This can be overcome by removing the plunger and using the priming kit to load or fill the system from the back. The kit contains one 250 µL syringe (P/N 81120), one six-pack of 30 gauge needles (P/N 90030), and one pack of 25 septa (P/N 75826).

Priming Kit

P/N	Description
PRMKIT	Syringe Priming Kit



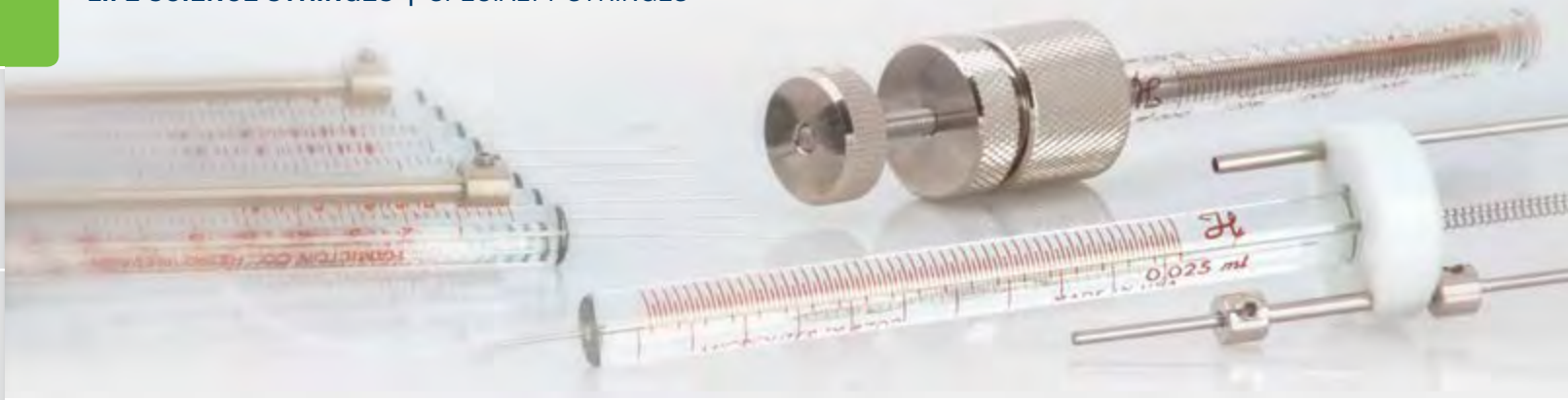

Specialty Syringes

Threaded Plunger Syringes

Threaded Plunger Syringes are used for precise manual positioning of the plunger. Rotation of the plunger aspirates or dispenses a defined volume of liquid. The Luer Tip connection is compatible with Kel-F Hub needles, tubing, and fittings.

Threaded Plunger Syringes

P/N	Volume	Plunger Type	$\mu\text{L}/\text{Revolution}$
80266	25 μL	Sleeve Type	0.33 μL
81041	100 μL	Sleeve Type	1.32 μL
81242	500 μL	Threaded Plunger	6.62 μL
81341	1 mL	Threaded Plunger	13.23 μL
81441	2.5 mL	Threaded Plunger	37.79 μL



Gel-Loading Syringes

Multi-Channel Gel-Loading Syringes (GLS) are designed for multiplex DNA sequencing methodologies. Rapidly transfer 1, 8, or 12 samples to sequencing gels, 96-well plates, or nylon membranes. The fixed, 25 mm long, blunt needles are spaced 9 mm apart and are available with three needle outer diameters for optimized sample transfers. The adjustable volume stop allows faster, more accurate reloading and excellent reproducibility.

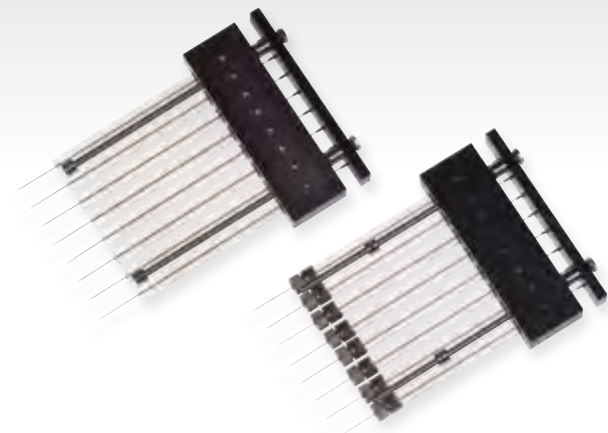

Gel-Loading Syringes (Cont.)

Cemented Needle Syringes



P/N	Description	Needle OD
80081	Single Channel	0.2 mm
84505	Single Channel	0.3 mm
84504	Single Channel	0.4 mm
84511	8-Channel	0.2 mm
84503	8-Channel	0.3 mm
84502	8-Channel	0.4 mm
84501	12-Channel	0.3 mm
84500	12-Channel	0.4 mm

Removable Needle Syringes

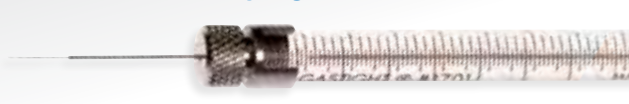

P/N	Description	Needle OD
80091	Single Channel	0.2 mm
84711	8-Channel	0.2 mm
8651-01	Replacement Needle 6 pk	0.2 mm
8651-02	Replacement Needle	0.3 mm
8651-03	Replacement Needle	0.4 mm

Adjustable Gel-Loading Syringes

Adjustable, Multi-Channel Gel-Loading Syringes (GLS) simplify and speed sample loading of 96-lane gels. They are compatible with a 96-lane ABI 377 DNA sequencing instrument. These syringes have an easy-to-use design for adjustment of needle spacing from 9 mm to 10.8 mm.

Adjustable Gel Loading Syringes

P/N	Description	Needle OD	Termination
84611	8-Channel Adjustable	0.2 mm	RN
78633	Replacement Needle 4 pk	0.2 mm	RN



Micro Syringe Pipette

Disposable tip pipetting for samples that are not compatible with traditional polypropylene pipette tips. The sample only wets the disposable PTFE tip, eliminating sample cross-contamination. The spring-loaded plunger and adjustable stops ensure excellent reproducibility of volumes from 0.2 μ L to 3 μ L. The 19 mm electro-tapered needle enables easy attachment of the PTFE tips.

Micro Pipette and Tips

P/N	Description
84250	0.2 – 3 μ L, Model 701 N Micro Syringe Pipette
84255	Disposable PTFE Tip – 100 pk





Syringe and Cleaning Accessories

Hamilton manufactures a variety of syringe accessories to improve or modify the functionality of a standard syringe. We offer tools to prevent plunger bending, to increase reproducibility, and to clean the syringe for a prolonged lifetime.



Plunger Support Accessories

For applications requiring additional plunger support and reproducibility, Hamilton manufactures several syringe series with reinforced plungers as well as plunger support accessories that are mounted to standard syringe series.



Plunger Support Accessories P. 68

Syringe and Needle Cleaning

Proper care and maintenance is critical for attaining maximum syringe life. Hamilton offers a variety of tools including needle cleaning wires, cleaning solutions, and storage racks.



Syringe and Needle Cleaning P. 71

Syringe Termination Adapters

Adapt the end of a removable needle syringe to a Luer or Luer Lock connection or add a septum or sample lock valve to a Luer or Luer Lock Syringe.



Syringe Termination Adapters P. 73

PB-600 Repeating Dispenser

This syringe accessory is used for precise aliquot dispensing from syringes between 10 µL to 2.5 mL.

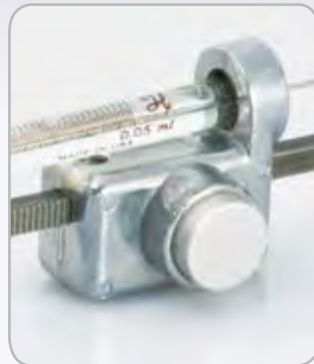

PB-600 Repeating Dispenser P. 75





Plunger Support Accessories

Small plunger diameters and rapid dispense speeds occasionally lead to misalignment and bent plungers. Hamilton offers several syringe series and accessories to address plunger bending and improve syringe life.

Reproducibility (Chaney) Adapters



P. 69

Syringe Guides



P. 70

600 Series Syringes

Combines a thick plunger to resist bending during operation with a fine plunger wire for small volume accuracy (page 17).

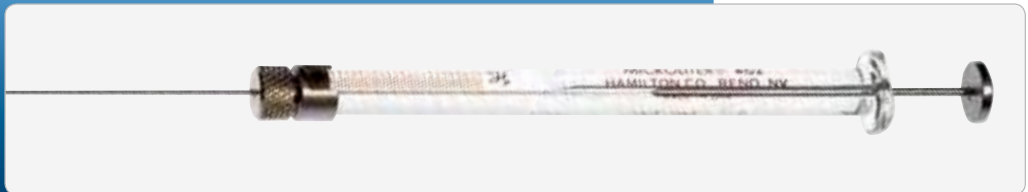

800/1800 Series Syringes

A blue syringe holder is attached to the back of the syringe. The holder has a thick plunger and the smaller syringe plunger is protected during operation (page 18/page 23).



Reproducibility (Chaney) Adapters

The Hamilton Reproducibility (Chaney) Adapter assures repetitive and identical syringe plunger location. Once the stop rod is adjusted to the desired fill volume the plunger can be repeatedly positioned without continuously reading the graduations.



Reproducibility (Chaney) Adapters

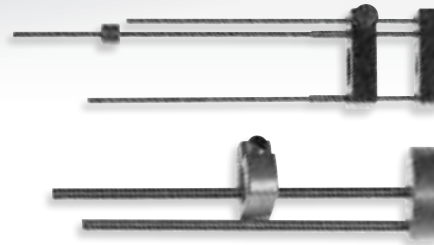

P/N	Volume	Series
14700	5 – 10 μ L	700/1700
14725	25 – 500 μ L	700/1700
32146	5 – 250 μ L	800/1800

Syringes Figure 4. 700/1700/7000 Series

Loosen the set screw and adjust the Stop Rod until it hits the Stop Button at the desired volume. Press the Stop Button to engage the stop, then release to dispense.

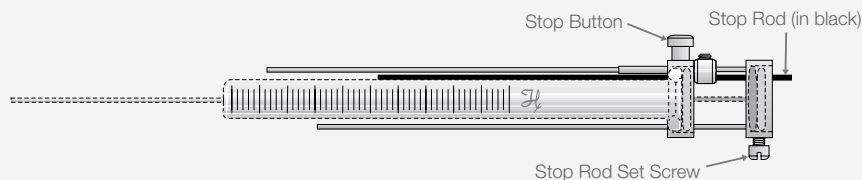

Syringes Figure 5. 800/1800 Series

Adjust the Stop Collar until the Stop Rod hits at the desired volume. To dispense, rotate the plunger so the Stop Rod travels past the Dispense Flat.

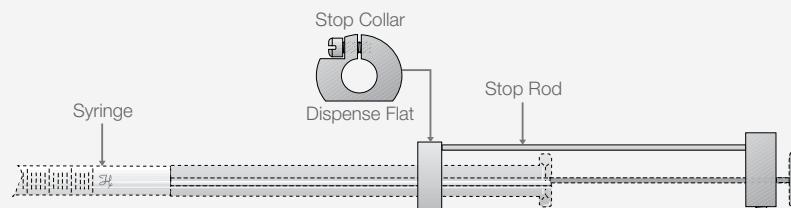

Syringes Figure 6. 1000 Series

Adjust the Stop Rod until it hits the Syringe Flange at the desired volume. To dispense, rotate the plunger so the Stop Rod travels past the dispense flat in the flange.

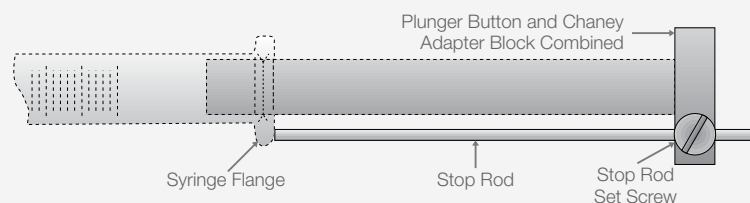

Reproducibility (Chaney) Adapters (Cont.)

7000 Series Built-in Chaney Adapters



P/N	Volume	Series	Length	Point
86252	0.5 µL	25 ga	70 mm	3
80104	1 µL	25 ga	70 mm	3
86204	1 µL	22 ga	70 mm	3
88404	2 µL	25 ga	70 mm	3
88504	2 µL	23 ga	70 mm	3
88004	5 µL	24 ga	70 mm	3

1000 Series Built-in Chaney Adapter



P/N	Volume	Series	Length	Point
81318	1 mL	22 ga	51 mm	2
81324	1 mL	Luer Lock (TTL)		
81418	2.5 mL	22 ga	51 mm	2
81403	2.5 mL	Luer Tip (LT)		
81424	2.5 mL	Luer Lock (TTL)		
81518	5 mL	22 ga	51 mm	2
81524	5 mL	Luer Lock (TTL)		
81618	10 mL	22 ga	51 mm	2
81624	10 mL	Luer Lock (TTL)		

Syringe Guides

The Syringe Guide is a cost effective way to prevent plunger damage during normal syringe operation. The guide is compatible with 700 and 1700 series syringes. It is also compatible with 7000 series syringes but requires the delicate removal and reinsertion of the plunger wire. For this reason the most popular 7000 series syringes can be ordered preassembled with the proper guide.

Syringe Guides

P/N	Volume	Series
14806	5 – 10 µL	700/1700
14906	25 – 500 µL	700/1700

7000 Series Built-in Syringe Guides



P/N	Volume	Gauge	Length	Point
86254	0.5 µL	25 ga	70 mm	3
80107	1 µL	25 ga	70 mm	3
86207	1 µL	22 ga	70 mm	3
88407	2 µL	25 ga	70 mm	3
88507	2 µL	23 ga	70 mm	3
88007	5 µL	24 ga	70 mm	3



Point Styles

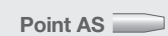
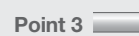



Syringe Storage and Cleaning

Syringe Rack

P. 71

Needle Cleaning

P. 72

Syringe Rack

The brushed stainless steel Syringe Rack stores up to five 700, 1700, or 7000 series syringes. The rack keeps your syringes from making contact with other syringes and minimizes the risk of sample contamination. Prevent breakage on the benchtop or save space by mounting to the wall.

Syringe Rack

P/N	Description
204880	5-Position Syringe Rack



Needle Cleaning

To clean syringes it is best to use a solvent known to be effective in solvating. Ideally the solvent would be non-alkaline, non-phosphate, and non-detergent based. Hamilton offers a biodegradable, non-phosphate, cleaning concentrate that is suitable for many common sample types.

For some needle obstructions, mechanical cleaning may be necessary. For this purpose Hamilton provides various sized tungsten cleaning wires that can be threaded through the needle to clear a blockage.



Needle Cleaning Kit

P/N	Volume
76620A	Kit includes 10 of each wire and 70 mL of concentrate

Cleaning Concentrate

P/N	Volume
18311	500 mL
18310	70 mL

Tungsten Cleaning Wires

P/N	For Gauges	Wire OD	Package
18304	22, 23 ga, and larger	0.306 mm	10 pk
18303	24 – 26 ga	0.207 mm	10 pk
18302	27 ga	0.167 mm	10 pk
18301	22s, 25s, and 28 – 30 ga	0.126 mm	10 pk
18300	26s and 31 – 33 ga	0.089 mm	10 pk
18306	23s ga	0.076 mm	10 pk

See “Syringe Care and Use” in the technical reference section for cleaning tips on page 77.





Syringe Termination Adapters

Removable Needle to Luer Adapters

250 μ L or Larger



P. 73

Inert Sampling Valve



P. 74

Septum Adapter



P. 74

Removable Needle to Luer Adapters

These adapters convert a Hamilton specific termination to an industry standard luer connection. They are compatible with SampleLock (SL) or Removable Needle (RN) syringes 250 μ L and larger. The internal diameter is 1 mm making it possible to spike samples with an internal standard using a 26 gauge needle or smaller.

RN to Luer Adapters

P/N	Description
35081	Female Luer Lock
35083	Male Luer Lock
35080	Male Luer

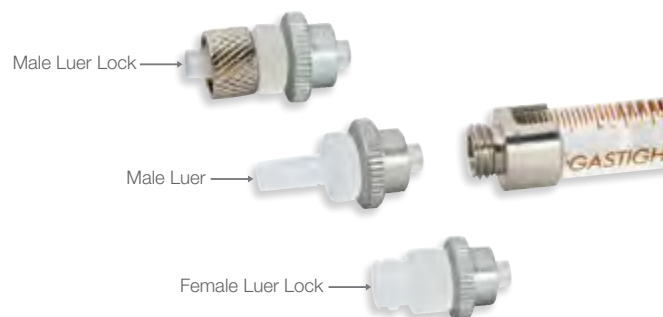



Inert Sampling Valve

The Inert Sampling Valve is a lever-actuated on/off valve used for storing and transporting samples. Connect to a Gastight syringe via the female luer lock, and use the male luer to attach to a needle, adapter, or tubing assembly. The valve is autoclavable with a 1 mm internal diameter and a pressure rating up to 0.7 MPa.

Inert Gas Sampling Valve

P/N	Description
86580	MTB Sampling Valve



Septum Adapter

The Septum Adapter turns any luer syringe into a sealed reaction container. Samples can be added or removed from the sealed container using another syringe to pierce the replaceable septum.

Luer Lock Septum Adapter

P/N	Description
31335	Adapter and 12 septa
75810	Replacement Septa 12 pk





PB-600 Repeating Dispenser

The PB-600 Repeating Dispenser is a low cost high accuracy accessory for repetitive dispensing. Each press of the button dispenses 1/50th of the syringe volume. The repeating dispenser is compatible with the cemented needle (N), removable needle (RN), luer tip (LT), or PTFE Luer Lock (TLL) syringes from 10 μ L to 2.5 mL. Syringes are sold separately.

PB-600 Repeating Dispenser

P/N	Dispense	Syringe	Series
83700	0.2 μ L	10 μ L	1700 Series
	0.5 μ L	25 μ L	700/1700 Series
	1 μ L	50 μ L	700/1700 Series
	2 μ L	100 μ L	700/1700 Series
	5 μ L	250 μ L	700/1700 Series
	10 μ L	500 μ L	700/1700 Series
	20 μ L	1 mL	1000 Series
	50 μ L	2.5 mL	1000 Series

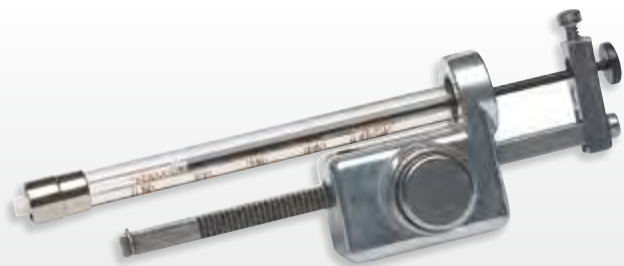



Syringe Technical Reference

The Syringe Technical Reference section includes detailed information on the operation, maintenance, and physical properties of most Hamilton syringes. The information is intended

as a general guideline. For specific details on a part number or application search for the part number on our website or contact a local Hamilton representative.

Syringe Care and Use	Daily Use Protocol, Plunger Care, Needle Care	P. 77, P. 79, P. 79
Syringe Specifications	Operating Parameters, Syringe Dimensions, Graduations	P. 80, P. 80, P. 81
Syringe Replacement Parts	800, 1000, 1700, 1800, 7000 Series, Super Syringe	P. 82, P. 83, P. 83, P. 83, P. 84, P. 84
Sterilization and Disinfection		P. 85
Frequently Asked Questions		P. 86
Syringe Calibration	Equipment and Materials, Calibration Procedure, Calculating Accuracy and Precision	P. 89, P. 90, P. 91

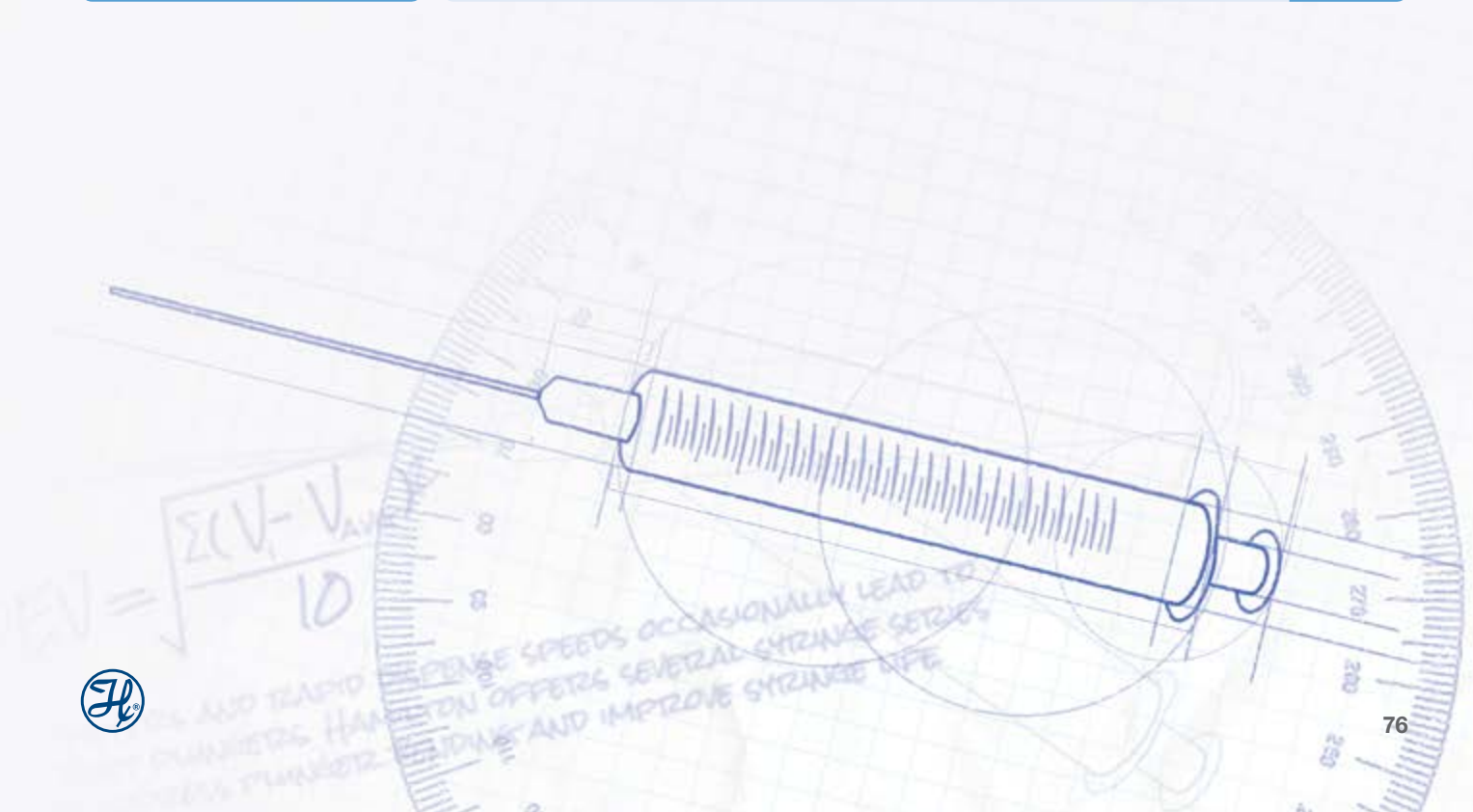



Syringe Care and Use

Operation of a syringe is relatively straight forward but there are some tips and tricks that will improve the performance and longevity of Hamilton syringes. This section is dedicated to best practices of operating and maintaining a syringe.

Daily Use Protocol

Step-by-step guide to syringe inspection, operation, cleaning, and storage.

P. 77

Plunger Care

The dos and don'ts of plunger maintenance.

P. 79

Needle Care

Tips on needle selection, inspection, and care.

P. 79

Daily Use Protocol

Step 1

Inspection

Before each use, thoroughly inspect the syringe for damage such as cracks and dried residue. Check the needle point for burrs from previous experiments. Do not use a needle with burrs. Burrs may tear GC septa leading to sample loss or poor peak shape.



Step 2

Grip

Avoid variations in liquid measure due to body heat by grasping the syringe flange and plunger as you draw and dispense fluids.

Syringes should be used at a constant temperature. Accuracy and reproducibility specifications are determined at 25 °C.

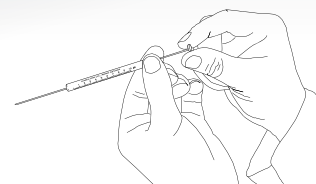

Daily Use Protocol (Cont.)

Step 3 Priming

Eliminate compressible trapped air by completely priming the syringe with sample. Immerse the needle point 2 mm to 3 mm into the sample solution. Then rapidly draw and dispense sample into the syringe until bubbles are no longer visible in the syringe barrel. Alternatively, remove air bubbles by turning the barrel upright and allowing the air bubbles to rise to the needle exit. Then dispense both the air bubbles and the sample.

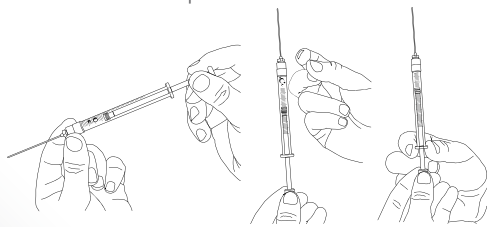

Step 4 Overfilling

Fill the syringe with a small amount of excess liquid.

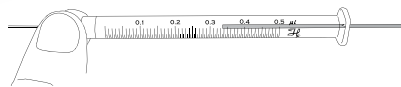

Step 5 Required Volume

Slowly dispense the excess sample until only the required volume of sample remains in the syringe. Visually check to see that the syringe scale and sample meniscus are parallel. It is optional to clean the exterior surface of the needle with a lint-free tissue. Avoid wicking sample with the tissue by making sure it does not come in contact with the needle opening.

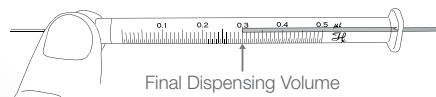

Step 6 Final Dispense

Dispense the final sample volume into an appropriate vessel.



Step 7 Cleaning

Rinse the syringe with a cleaning solvent known to solubilize the sample. Then rinse with deionized water, and finally rinse with high purity acetone. Allow time for the acetone to evaporate before storing the syringe. Do not soak or submerge the entire syringe in any cleaning agent.

The preferred cleaning agents are non-alkaline, non-phosphate, and non-detergent based. Hamilton offers a biodegradable, non-phosphate, organic Cleaning Solution Concentrate (P/N 18311).

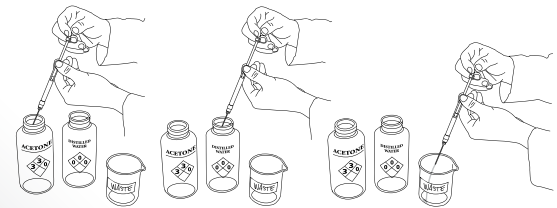

Step 8 Storage

Store the syringe in its original packaging or the Syringe Rack (P/N 204880) to protect against breakage.

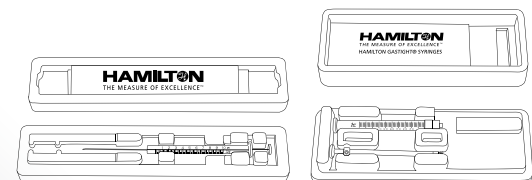

Step 9 Solvent Compatibility

The adhesive used to affix needles and hubs to Hamilton Microliter and Gastight syringes is the most chemically resistant available. However, with prolonged exposure, some solvents may attack and deteriorate this highly resistant adhesive. In particular, caution should be exercised with solvents containing halogenated hydrocarbons such as dichloromethane (methylene chloride). For applications using these solvents, Removable Needle (RN) syringes are recommended because no adhesive is present in the fluid path.





Plunger Care

Plungers are made of solid stock material and push the sample out of the syringe. Hamilton makes two types of plungers. The plungers on Microliter syringes are hand-fitted and are only liquid-tight. The plungers are not replaceable for Microliter syringes except for the 7000 series. The plungers on Gastight syringes have a PTFE tip and are replaceable. The PTFE tip creates a gas-tight fit against the interior of the glass barrel, making these syringes ideal for gases and liquids.

Dry Microliter Syringes

Always pull liquid into a syringe barrel to wet the interior surface. Avoid unnecessary moving or pumping of the plunger in a dry syringe. Excessive dry pumping increases plunger wear, shortens syringe life expectancy, and may lead to damage beyond repair.

Touching the Plunger

Avoid touching the plunger with your fingers. Abrasions, scratches, or oil due to handling the plunger with your fingers may interfere with proper plunger operation.

Accidental Plunger Removal

If the plunger is inadvertently removed from the syringe barrel, wipe it carefully with a lint-free tissue. Reinsert the plunger into the barrel and pump deionized water or acetone through the needle and syringe. In the case of Gastight plungers, dip the PTFE plunger tip into deionized water to re-wet it prior to reinserting the plunger into the barrel.

Binding Plungers

If the plunger feels like it is binding or rough, it may be soiled or bent. Do not apply force to move a plunger. Too much pressure can irretrievably bend the plunger or crack the syringe glass barrel. Try using an appropriate solvent and wiping with a lint-free cloth.

Needle Care

Use extreme caution in handling needles to avoid bending, contamination, or accidental personal injury. A variety of needle point styles and lengths are offered to meet the requirements of different applications. All Hamilton needles are electro-polished to assure smooth and burr-free products.

Sample Viscosity

Needles are designed to draw samples of normal viscosity. Samples with higher viscosity may need to be diluted. You may also consider using a needle with a larger inner diameter.

Dead Volume

Once your sample is dispensed, a small residual amount of sample remains in the needle. The amount of dead volume depends on the needle inner diameter and termination style. For example, with cemented or removal needles, the dead volume is generally less than 1 μL for small volume syringes and as much as 6.8 μL for large volume syringes.

Needle Bending

Avoid bending needles by selecting the largest needle outside diameter suitable for your application. Generally, bent needles cannot be straightened adequately for reliable operation.

Needle Burrs and Surface

Burrs, rough edges at the needle opening, and a rough needle surface can be removed by gently rubbing with a fine emery cloth or fine carborundum paper. Make sure to thoroughly rinse and dry the needle before using.

Clogged Needles

For a partially clogged needle, flush the syringe with an appropriate solvent to solubilize the clog. For a completely clogged needle, do not attempt to clean by forcing liquid or compressed air through the syringe. Excessive pressure could split the glass barrel. Alternatively, use the Hamilton Needle Cleaning Kit (P/N 76620A). Start by using the cleaning wires to dislodge any foreign material. Then flush with the Cleaning Solution Concentrate to further dissolve the clog. Once the clog is removed, rinse the syringe and needle thoroughly with deionized water. Wipe the exterior surfaces of the syringe barrel and needle dry with a lint-free tissue. Make sure that there is no residual cleaning agent in the syringe before using or storing the syringe.





Syringe Specifications

Operating Parameters

Operating temperature and pressure varies based on syringe size, plunger type, and syringe termination. In the table below are the general operating parameters for Hamilton syringes. Part number specific data sheets are available by searching the part number at www.hamiltoncompany.com.

Operating Parameters

Volume	Series	Pressure	Temperature
0.5 – 10 µL	7000	41 MPa	10 – 115 °C ¹
	600	14 MPa	10 – 115 °C ¹
	700	14 MPa	10 – 115 °C ¹
	800	14 MPa	10 – 115 °C ¹
	1700	7 MPa	10 – 115 °C ¹
	1800	7 MPa	10 – 115 °C ¹
25 – 100 µL	700	7 MPa	10 – 115 °C ¹
	800	7 MPa	10 – 115 °C ¹
	1700	7 MPa	10 – 115 °C ¹
250 µL – 10 mL	1800	7 MPa	10 – 115 °C ¹
	700	7 MPa	10 – 115 °C ¹
	800	7 MPa	10 – 115 °C ¹
	1700	3 MPa	10 – 115 °C ¹
25 – 100 mL	1800	3 MPa	10 – 115 °C ¹
	1000	1 MPa	10 – 115 °C ¹
0.5 – 2 L	Super Syringe	0.2 MPa	0 – 80 °C

¹ If the syringe termination is a cemented needle or luer tip cemented needle then the maximum temperature is 50 °C.

Syringe Dimensions

Most Hamilton syringes are standardized to a 60 mm plunger stroke length, and where possible, the same barrel outer diameter is used. For each syringe volume the inner diameter will change to accommodate the desired dispense volume.

Syringe Dimensions

Volume	Barrel OD	Barrel ID	Stroke Length
0.5 µL	7.8 mm	0.104 mm*	60 mm
1.0 µL	7.8 mm	0.145 mm*	60 mm
2.0 µL	7.8 mm	0.206 mm*	60 mm
2.5 µL	6.6 mm	0.34 mm	27 mm
5 µL 600 Series	6.6 mm	0.48 mm	27 mm
5 µL 700, 800 Series	6.6 mm	0.34 mm	54 mm
5 µL 7000 Series	7.8 mm	0.325 mm*	60 mm
10 µL 700, 800 Series	6.6 mm	0.49 mm	54 mm
10 µL 1700, 1800 Series	6.6 mm	0.46 mm	60 mm
25 µL	7.7 mm	0.73 mm	60 mm
50 µL	7.7 mm	1.03 mm	60 mm
100 µL	7.7 mm	1.40 mm	60 mm
250 µL	7.7 mm	2.30 mm	60 mm
500 µL	7.7 mm	3.26 mm	60 mm
1.0 mL	9.0 mm	4.61 mm	60 mm
2.5 mL – Thin Wall	9.7 mm	7.29 mm	60 mm
2.5 mL	10.3 mm	7.29 mm	60 mm
5 mL	13.5 mm	10.30 mm	60 mm
10 mL	17.7 mm	14.57 mm	60 mm
25 mL	27.1 mm	23.03 mm	60 mm
50 mL	36.9 mm	32.54 mm	60 mm
100 mL	36.9 mm	32.54 mm	120 mm
500 mL	75 mm	62 mm	166 mm



Syringe Dimensions (Cont.)

Syringe Dimensions (Cont.)

Volume	Barrel OD	Barrel ID	Stroke Length
1.0 L	100 mm	87 mm	167 mm
1.5 L	100 mm	87 mm	250 mm
2.0 L	100 mm	87 mm	334 mm

*For the 7000 series syringes the ID measurement is based on the OD of the plunger wire.

Syringes Figure 7. Syringe dimensions

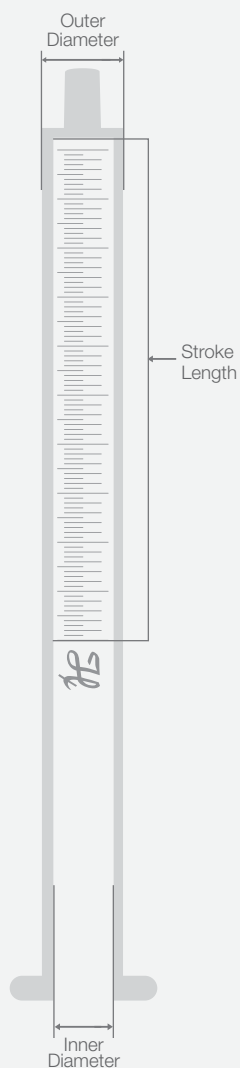

Graduations

All manual Hamilton syringes have silkscreened graduations to assist in the precise positioning of the plunger. To simplify reading of the silkscreen there are three different types of graduation marks: major, minor, and sub-minor.

Graduations

Volume	Major	Minor	Sub-minor
0.5 µL	0.05 µL	0.01 µL	0.005 µL
1 µL	0.1 µL	0.02 µL	0.01 µL
2 µL	0.2 µL	0.04 µL	0.02 µL
2.5 µL	0.5 µL	0.1 µL	0.05 µL
5 µL 600 Series	1.0 µL	0.2 µL	0.1 µL
5 µL	0.5 µL	0.1 µL	0.05 µL
10 µL	1.0 µL	0.2 µL	0.1 µL
25 µL	2.5 µL	0.5 µL	0.25 µL
50 µL	5.0 µL	1.0 µL	0.5 µL
100 µL	10 µL	2.0 µL	1.0 µL
250 µL	25 µL	5.0 µL	2.5 µL
500 µL	50 µL	10 µL	5.0 µL
1 mL	100 µL	20 µL	10 µL
2.5 mL	250 µL	50 µL	25 µL
5.0 mL	500 µL	100 µL	50 µL
10 mL	1,000 µL	200 µL	100 µL
25 mL	2,500 µL	500 µL	250 µL
50 mL	5,000 µL	1,000 µL	500 µL
100 mL	5,000 µL	1,000 µL	500 µL
0.5 – 2.0 L	100 mL	20 mL	N/A

Syringes Figure 8. Graduation marks

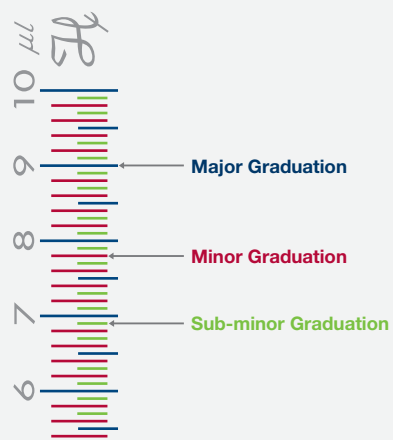



Syringe Replacement Parts

A limited selection of replacement parts and accessories are available for Hamilton syringes. For Gastight syringes most common plungers are available. For Microliter syringes the plunger is hand-fit to the barrel so a replacement plunger is not offered.

Removable Needle Nut

All Removable Needle (RN) syringes use part number 30902 for the replacement nut.

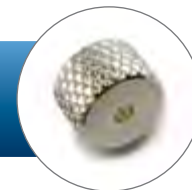

800 Series Syringe Replacement Parts

Holder Assembly



P/N	Volume
32135	5 – 250 μ L

Barrel/Plunger Assembly

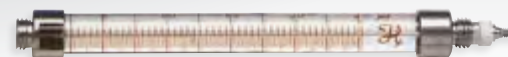

P/N	Volume	Termination	Gauge
32150	5 μ L	Cemented Needle	26s ga
32134	5 μ L	Removable Needle	No Needle
32151	10 μ L	Cemented Needle	26s ga
32165	10 μ L	Removable Needle	26s ga
32129	10 μ L	Removable Needle	No Needle
32166	25 μ L	Removable Needle	22s ga
32117	25 μ L	Removable Needle	No Needle
32120	50 μ L	Removable Needle	No Needle
32168	100 μ L	Removable Needle	22s ga
32123	100 μ L	Removable Needle	No Needle
32169	250 μ L	Removable Needle	22s ga
32126	250 μ L	Removable Needle	No Needle

Note: All included needles are 51 mm long with a point style 2.



Point Styles

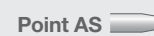
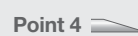

1000 Series Syringe Replacement Parts

Spindle/Tip Assembly

P/N	Volume
52343-01	100 mL

Plunger Assembly



P/N	Volume
1359-01	1 mL
1360-01	2.5 mL
13230	5 mL
13231	10 mL
13271	25 mL
13272	50 mL

1700 Series Syringe Replacement Parts

Plunger Assembly



P/N	Volume	Plunger Stop
13205	10 µL	No
1122-01	25 µL	No
13269	25 µL	Yes
1162-01	50 µL	No
1117-01	50 µL	Yes
1162-02	100 µL	No
1117-02	100 µL	Yes
1162-03	250 µL	No
1117-03	250 µL	Yes
1169-01	500 µL	No
1120-01	500 µL	Yes

1800 Series Syringe Replacement Parts

Holder Assembly



P/N	Volume
32135	10 – 250 µL

Plunger Assembly

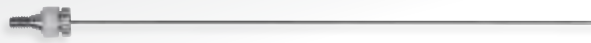

P/N	Volume
32193	10 µL
1160-01	25 µL
1161-01	50 µL
1161-02	100 µL
4871-01	250 µL

Glass Barrel

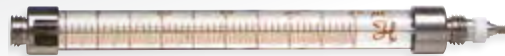

P/N	Volume	Termination	Gauge
32175	10 µL	Cemented Needle	26s ga
32187	10 µL	Removable Needle	No Needle
32188	25 µL	Removable Needle	No Needle
32189	50 µL	Removable Needle	No Needle
32190	100 µL	Removable Needle	No Needle
32191	250 µL	Removable Needle	No Needle

Note: All included needles are 51 mm long with a point style 2.



7000 Series Syringe Replacement Parts

Replacement Plunger and Needle Assemblies

P/N	Volume	Gauge	Length	Point
17887	0.5 µL	25 ga	70 mm	2
17187	0.5 µL	25 ga	100 mm	3
86258	0.5 µL	32 ga	70 mm	3
17888	1.0 µL (7001)	25 ga	70 mm	2
17188	1.0 µL (7001)	25 ga	70 mm	3
17890	1.0 µL (7101)	22 ga	70 mm	2
17190	1.0 µL (7101)	22 ga	70 mm	3
17891	2.0 µL (7002)	25 ga	70 mm	2
17191	2.0 µL (7002)	25 ga	70 mm	3
17192	2.0 µL (7102)	23 ga	70 mm	3
17893	5.0 µL	24 ga	70 mm	2
17193	5.0 µL	24 ga	70 mm	3

The 7000 series syringes have a plunger wire that runs inside the needle. The kit comes with a replacement plunger and needle so both can be changed at the same time. The plunger wire is extremely delicate and care must be taken not to cause damage during installation.

Super Syringe Replacement Parts

Plunger Replacement Parts

P/N	Volume	Description
18007	0.5 – 2.0 L	Piston Rod Knob
18005	0.5 – 1.0 L	Piston Rod
18053	0.5 L	Piston Disk
18054	1.0 – 2.0 L	Piston Disk
16160	0.5 L	Piston Disk O-ring
16161	1.0 – 2.0 L	Piston Disk O-ring



Point Styles

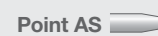



Sterilization and Disinfection

Cycling a syringe in an autoclave can result in damage caused by the metal and glass parts expanding at different rates. The table below shows the recommended chemicals

for disinfection and the syringe types that can withstand repeated autoclave cycles. As an alternative to the autoclave, all glass syringes can be sterilized using ethylene oxide.

Sterilization and Disinfection Table

Product	Autoclave Sterilization	Chemical Disinfection ¹
Cemented Needle Syringes	No	Yes, no bleach
Luer Tip Cemented Needle Syringes	No	Yes, no bleach
Fixed Needle Syringes	No	Yes, no bleach
Luer Tip Syringes	Yes	Yes
PTFE Luer Lock Syringes	Yes, except 25 mL and larger	Yes
Removable Needle Syringes	Yes	Yes, no bleach
Knurled Hub Syringes	Yes	Yes
SampleLock Syringes	No	Yes, no bleach
ChemSeal Syringes	Yes	Yes
Carbon Analyzer Syringes	No	Yes, no bleach
Constant Rate Syringes	No	Yes, no bleach
Neuros Syringes	Yes	Yes
Removable Needles (18 – 26s gauge)	Yes	Yes
Removable Needles (27 – 34 gauge)	Yes	Yes
Metal Hub Needles	Yes	Yes
Kel-F Hub Needles	Yes	Yes
PTFE Tubing	Yes	Yes
Kel-F Fittings	Yes	Yes

¹Recommended disinfecting chemicals are Microcide SQ® (P/N 3995-01), 10% bleach, acetone, or ethanol.

Syringes should be disassembled prior to autoclaving at 120 °C for 20 min.





Frequently Asked Questions

Below is a list of commonly asked questions. Find your question and then turn to the page to see the answer. If your question is not listed please contact your Hamilton representative.

Syringe Questions

- 1 → What is the accuracy of Hamilton syringes? P. 87
- 2 → Can Hamilton syringes be used on humans? P. 87
- 3 → Are the plungers for the Microliter syringes (600, 700, and 800 series) interchangeable? P. 87
- 4 → The plungers on the 700 series syringes move when very little force is applied. Can this be prevented? P. 87
- 5 → What are the most versatile syringes made by Hamilton? P. 87
- 6 → Why doesn't my RN adapter fit into my RN syringe? P. 87
- 7 → How do I adjust the needle exposure on my Neuros syringe? P. 87
- 8 → Do the 7000 Series Neuros syringes have replacement parts? P. 87
- 9 → How do you backfill syringes? P. 87

Needle Questions

- 10 → How do I find my needle for my syringe? P. 88
- 11 → Is the needle dead volume part of the total volume of the dispensed fluid? P. 88
- 12 → What does the "s" mean in a 22s or 26s gauge needle? P. 88
- 13 → Does Hamilton offer a needle sheath? P. 88
- 14 → Can disposable needles work with Hamilton syringes? P. 88



Syringe Questions

1 What is the accuracy of Hamilton syringes?

Hamilton syringes are manufactured to be accurate within $\pm 1\%$ of nominal volume, and with precision within 1%, measured at 80% of total scale volume. Our ISO 9001-2008 certified Quality System uses rigorous testing and quality checks to ensure the highest levels of accuracy and precision. To obtain a syringe-specific certificate the syringe must be purchased as a Calibrated Syringe (page 26).

2 Can Hamilton syringes be used on humans?

No, Hamilton syringes are labeled “Not for Human Use”. To discuss potential off label uses for Hamilton syringes please contact us.

3 Are the plungers for the Microliter syringes (600, 700, and 800 series) interchangeable?

No, each plunger is hand-fitted to the corresponding syringe barrel. Be very careful to keep each plunger with its original syringe barrel in order to maximize syringe performance.

4 The plungers on the 700 series syringes move when very little force is applied. Can this be prevented?

The plungers on Microliter syringes are designed to move freely to enable rapid injection into a GC. If more resistance is desired a Gastight syringe is recommended. The Gastight plunger uses a plastic seal between the plunger and syringe barrel, resulting in additional drag force to move the plunger.

5 What are the most versatile syringes made by Hamilton?

In our opinion, Gastight syringes with the Removable Needle termination are the most versatile. The plungers and the needles are replaceable if they get bent or wear out. Additionally, the dead volume of the Removable Needle termination is as small as a Cemented Needle syringe which is critical for small volume syringes.

6 Why doesn't my RN adapter fit onto my RN syringe?

The RN adapters are compatible with any SampleLock syringes or with Removable Needle syringes between 250 μL – 10 mL. If the proper size syringe is being used it is possible that the white ferrule from the previously installed needle is still stuck in the hub. This must be removed prior to installation of the RN adapter.

7 How do I adjust the needle exposure on my Neuros syringe?

To expose the needle loosen the RN nut on the end of the adapter, and then gently push the needle sleeve down. Be careful not to put your finger over the needle hole when moving the needle sleeve down. Sometimes the needle sleeve may be a little tight when using it for the first time.

8 Do the 7000 series Neuros syringes have replacement parts?

No, due to the design of the 7000 series needle plunger assembly the 7000 series Neuros syringes do not have any replacement parts.

9 How do you backfill syringes?

Backfilling a syringe can be useful when the syringe is connected to a needle or tubing with a large dead volume. Excessive dead volume makes the system difficult to prime and filling from the back may be the only option. Backfilling should not be used if the needle is clogged because reinsertion of the plunger can result in excessive backpressure and a cracked syringe barrel.

To backfill a Hamilton syringe, simply remove the plunger and load the solution from the back using a second syringe. Once the air bubbles are flushed out remove the second syringe and reinsert the plunger. For this purpose Hamilton offers a Priming Kit (P/N PRMKIT) which is recommended for syringes as small as 5 μL .

Note: This procedure is valid for 700 and 1700 series syringes only.





Needle Questions

10

How do I find a needle for my syringe?

Use the tutorial on page 9 to determine what needles are compatible with your syringe. Then turn to the Needles section to find a part number.

11

Is the needle dead volume part of the total volume of the dispensed fluid?

No, the liquid in the needle is not part of the dispense volume. The needle contains a constant dead volume throughout the aspirate and dispense steps.

When performing a GC injection one thing to consider is that the sample is aspirated at room temperature. When the sample is dispensed the needle starts to warm up to the temperature of the GC inlet. If the sample trapped in the needle is volatile it may begin to expand and result in the introduction of additional sample into the GC. To minimize this effect it is critical that the injection timing is the same for all injections.

12

What does the “s” mean in a 22s or 26s gauge needle?

For needles the gauge indicates the outer diameter of the needle tubing. The difference between a 26 gauge needle and a 26s gauge needle is the thickness of the tubing wall. The “s” needles have a thicker wall which results in a more rigid needle and a smaller dead volume. Smaller dead volume needles come standard on small volume syringes to make them practical to prime.

A table of available needle gauges and their dimensions can be found on page 119.

13

Does Hamilton offer a needle sheath?

No, Hamilton does not offer a needle sheath. Our syringes are not for human use, and our needles do not come with a medical point. If a sheath is required it is possible to buy a third party Luer Lock needle and attach it to a Hamilton Luer Tip or Luer Lock syringe.

14

Can disposable needles work with Hamilton syringes?

Yes, our Luer Tip (LT) and PTFE Luer Lock (TLL) syringes can accept most industry standard disposable luer lock needles.





Syringe Calibration

This syringe calibration procedure is based on determining the mass of deionized water samples delivered by the syringe. True volume is calculated based on the density of water at

the calibration temperature. This method is not recommended for volumes below 2 μL . There is no upper volume limit.

Equipment and Materials

Step 1

Laboratory balances required for the test method should meet or exceed the following performance specifications and should be regularly maintained and calibrated with the appropriate N.I.S.T. traceable weights.

Test Volume (μL)	Balance Sensitivity (mg)
1 – 10	0.001
10 – 100	0.01
100 – 1,000	0.1

Step 2

Use a balance table, or suitable equivalent to minimize vibration.

Step 3

Use a weighing vessel that has a total volume 12 to 40 times larger than the test volume, or 500 μL , whichever is larger (this is for evaporation control). If possible, use a cover that fits over the outside of the vessel top (do NOT allow the cover to come into contact with the test liquid). The vessel should be plastic, glass, metal, or some other non-porous material. The cross-sectional area of the opening should be as small as possible to further minimize evaporation.

Step 4

Handle the vessel with forceps or tweezers.

Step 5

Use deionized water that has equilibrated to room temperature.

Step 6

Use a calibrated thermometer to measure the temperature of the water.





Calibration Procedure

Step 1

Allow all test materials to equilibrate to room temperature (Note: For best results, this procedure should be performed at 22 °C – 26 °C.)

Step 2

Place a small amount of deionized water in the weighing vessel (between 2 and 30 test volumes).

Step 3

Fill a reservoir with deionized water and aspirate water into the syringe. Remove any bubbles by slowly aspirating and quickly dispensing the water several times.

Step 4

Place the weighing vessel on the balance pan and close the door of the balance chamber.

Step 5

Aspirate the sample to be measured. Hamilton uses 80% of the nominal volume for calibration.

Step 6

Tare the balance. Retrieve the weighing vessel from the balance chamber, dispense the volume of water, and return the vessel to the balance pan, closing the door to the weighing chamber. Record the mass of the deionized water.

Step 7

Weigh 10 samples into the weighing vessel and record each sample mass after delivery. Replicate all motions and time intervals in each sampling cycle as precisely as possible. Keep the distance between the balance and the syringe to a minimum.

Step 8

Measure and record the water temperature.



Calculating Accuracy and Precision

Step 1

Calculate the volume of each dispense (V_i) by dividing each mass value by the density of water at the measured temperature. Refer to the table below for density values.

Density of Water at Various Temperatures

°C	g/mL
18	0.998595
19	0.998405
20	0.998203
21	0.997992
22	0.997770
23	0.997538
24	0.997296
25	0.997044
26	0.996783
27	0.996512
28	0.996232
29	0.995944
30	0.995646

Data from CRC Handbook of Chemistry and Physics, 50th Edition, 1969, page F-4

Step 2

Calculate the average dispensed volume from the individual dispensed volumes, V_i (where i is 1 to 10):

$$V_{avg} = \frac{(V_1 + V_2 + V_3 + \dots + V_{10})}{10}$$

Step 3

Calculate the syringe accuracy (where V_0 is equal to the expected dispense volume):

$$Accuracy (\%) = \left[\frac{(V_{avg} - V_0)}{V_0} \right] \times 100\%$$

Step 4

Calculate the standard deviation (STDEV) of the calculated volumes:

$$STDEV = \sqrt{\frac{\sum(V_i - V_{avg})^2}{10}}$$

Step 5

Determine the precision (coefficient of variation – CV):

$$CV (\%) = \frac{STDEV}{V_{avg}} \times 100\%$$



Hamilton Reference Guide
Needles





Needles

Introduction 95

I have a syringe, which needle do I need? 96

Needles 101: Definitions and Terminology97

Needles 102

Luer Lock Needles 104

 Kel-F Hub Needles.....105

 Metal Hub Needles106

Removable Needles 107

 Large Hub Removable Needles108

 Small Hub Removable Needles.....109

Specialty Needles 110

 Stainless Steel Tubing 110

 Glass Micro Pipettes 111

 Thin-Layer Chromatography (TLC) Needles 111

 Gel-Loading Needles 112

 PEEK Needles.....112

 Valve Port Needles.....112

Needle Cleaning Accessories..... 113

 Needle Cleaning Kit 113

 Cleaning Concentrate Solution..... 113

 Tungsten Cleaning Wires 113

Needle Technical Reference..... 114

Needle Care and Use 115

Sterilization and Disinfection..... 118

Gauge Index..... 119

Syringes 2

Index 120





Needles

Hamilton needles are manufactured with top quality materials and skilled workmanship ensuring the highest possible performance for reliable analyses. With proper care and handling, Hamilton needles provide unsurpassed performance.

Introduction

Product finder tutorials to simplify finding the right needle. Not familiar with the terminology? Visit the Needle 101 section for definitions and terminology.



Introduction

P. 96

Needles

Needles are grouped based on needle type such as Luer Lock, Removable Needles, Specialty Needles, and Needle Cleaning Accessories.



Needles

P. 102

Needle Technical Reference

This section contains the most frequently requested needle reference information including: needle care and use, sterilization and disinfection, and needle dimensions.



Needle Technical Reference

P. 114



Find Your Product

I have a syringe, which needle do I need?

If you already have a syringe and need a Hamilton needle, review the three options below to determine which needle hub is compatible with your syringe. Once the needle hub is identified turn to the corresponding page to browse the available needle gauges, lengths, and point styles.

Option 1

I already know my syringe termination

Below are the syringe terminations that accept replacement needles. Identify your termination below and proceed to the corresponding needle hub page to see the compatible needle part numbers.

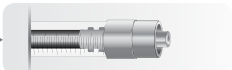
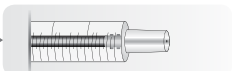
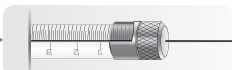
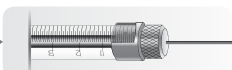
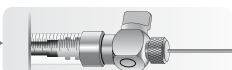
Terminations		Needle Hubs	Page
TLL - PTFE / Luer Lock		Kel-F Hub Metal Hub	P. 105 P. 106
LT - Luer Tip		Kel-F Hub	P. 105
RN - Removable Needle 100 µL or Smaller		Small Hub RN	P. 109
RN - Removable Needle 250 µL or Larger		Large Hub RN	P. 108
SL - SampleLock		Large Hub RN	P. 108

Option 2

I know my syringe part number, but not the termination

If you know the syringe part number but do not know what termination it has, you can look up the part number in the index at the back of this guide. You will be directed to the page where the part number is displayed, indicating the syringe termination. Alternatively, you can search for the part number at www.hamiltoncompany.com where the product page will list the termination and the compatible needle hub. Once the termination is determined use Option 1 to find the page where the appropriate needles are listed.

Option 3

I have a plastic syringe and need a compatible needle

Many plastic syringes use an industry standard Luer or Luer Lock connector. For these syringes both the Hamilton Metal Hub (page 106) and the Kel-F Hub (page 105) needles are compatible.



Needles 101:

Definitions and Terminology

This section is designed to provide an overview of the different types of needles that Hamilton offers including a discussion of hub

styles, needle point styles with a discussion on calculating the bevel length, needle lengths, and choosing a needle gauge for an application.

Anatomy of a Needle

The needle hub is attached to the needle cannula and is used to connect the needle to a syringe, tube, or fitting. The opposite end of the needle is shaped into a needle point style that is appropriate for the application.

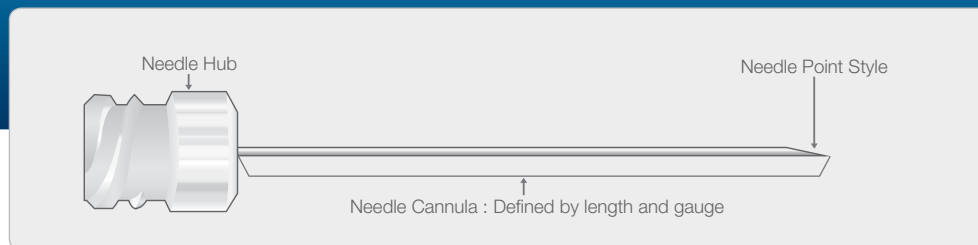

Needle Hub Styles

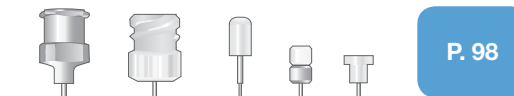

Needle Point Styles

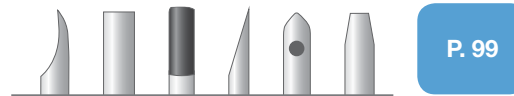

Specifying Needle Length



Choosing the Appropriate Gauge

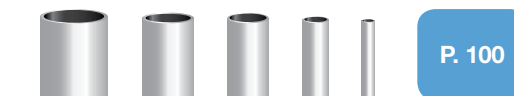





Needle Hub Styles

The tables below discuss the different hub styles that Hamilton offers.

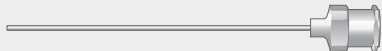

Luer Lock Needle Hubs

Designed to fit any standard Luer or Luer Lock syringe or fitting.

	Needle Hub Style	Needle Gauge	Compatible with:
Metal Hub Needle		33 – 10 gauge	25 µL to 2 L – PTFE Luer Lock (TLL) Syringes
Kel-F Hub Needle		31 – 10 gauge	25 µL to 2 L – PTFE Luer Lock (TLL) Syringes 10 µL to 10 mL – Luer Tip (LT) Syringes

Removable Needle Hubs

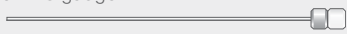
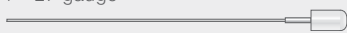
Seated at the zero line of the syringe, minimizing dead volume, and enabling complete priming of small volume syringes. The difference between a Small and Large Hub Removable Needle (RN) is the outer diameter of the hub and ferrule. There are two versions of the Small Hub RN because at smaller than 27 gauge the tubing wall is too thin to stake the hub in place.

	Needle Hub Style	Needle Gauge	Compatible with:
Small Hub Removable Needle	26 – 18 gauge 	34 – 18 gauge	2.5 µL to 100 µL – Removable Needle (RN) Syringes
	34 – 27 gauge 		
Large Hub Removable Needle		26s – 20 gauge	250 µL to 10 mL – Removable Needle (RN) Syringes 50 µL to 100 mL – SampleLock (SL) Syringes

Detachable Ferrules

Some Removable Needles have a detachable ferrule as shown below.

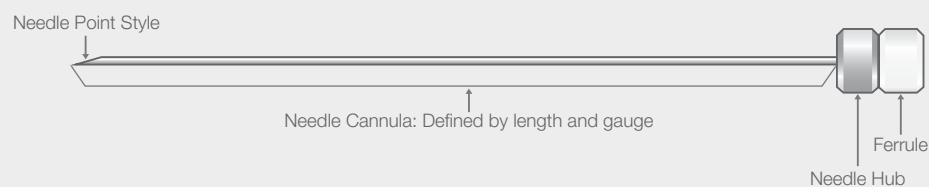

Valve Port Needle Hubs







Used to connect the needle to a tubing port on a Hamilton valve.

	Needle Hub Style	Needle Gauge	Compatible with:
Hat Needle		26 – 14 gauge	Connected directly to a ¼"-28 flat bottom valve port using needle bushing part number 35056



Needle Point Styles

Hamilton offers several different needle point styles depending on the intended application. For most syringes and needles, the standard length is 51 mm. Customization of the needle gauge, length, and point style is possible to suit almost any application.

ID	Point Style	Description	Application	Gauges
2		10 – 12° sharp, beveled, curved non-coring	Gas Chromatography (GC), septum piercing	33 – 10 ga
3		Blunt, electro-polished	High Performance Liquid Chromatography (HPLC) injection, Thin-Layer Chromatography (TLC), general liquid handling, controlled animal injections	34 – 10 ga
3T		Blunt, electro-polished, coated with PTFE 19 mm from the tip	Thin-Layer Chromatography (TLC) applications	26s, 22s, and 22 ga
4		Sharp 10 – 12° beveled needle; other angles available upon request	Life science/animal injections	34 – 10 ga
5		Conical with side port for penetration without coring	Headspace, applications prone to needle clogging, causes minimal septum damage	26 – 10 ga
AS		Conical, non-coring designed to withstand multiple injections	Autosampler injection, pre-pierced septa	26 – 10 ga

Calculating Point Style 4 Bevel Length

Neuroscience injections require precise positioning of the needle in the brain. Liquid exits the needle from the start of the bevel so knowing the bevel length is critical. It is possible to calculate the bevel length by knowing the outer diameter (OD) of the needle tubing and the bevel angle.

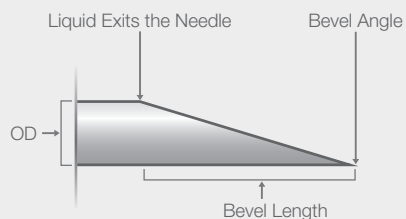

$$\text{Bevel Length} = \frac{\text{OD}}{\tan(\text{Bevel Angle})}$$





For example: A 27 gauge needle (OD = 0.413) with a point style 4 beveled at 30 degrees:
Bevel length = 0.413 mm / tan30 = 0.715 mm



Specifying Needle Length

The needle length for most standard Hamilton needles is 51 mm \pm 1 mm. If a custom length is desired, it is critical to understand how to specify the desired length. The table below shows the length that is specified when ordering each hub style.

Custom needles are available in lengths from 10 mm to 304 mm. If a longer needle is required, contact your local representative to determine available possibilities.

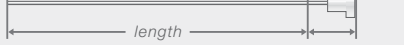
Hub Style	Length Determination	Image
Metal Hub Needle	Needle length is specified from the needle point to the start of the hub.	
Kel-F Hub Needle	Needle length is specified from the needle point to the start of the hub.	
Standard RN Hub Needle	Needle length is specified from the needle point to the start of the RN nut. The distance from the needle point to the hub is length + 1.8 mm.	
Small Gauge RN Hub Needle	Needle length is specified from the needle point to the start of the support sleeve.	
Hat Hub Needle	Needle length is specified from the needle point to the start of the installation hardware. The distance from the needle point to the back end of the hub is length + 14.22 mm.	

Choosing the Appropriate Gauge

Needle gauge specifies the outer diameter of the tubing used to make the needle. As the needle gauge increases the outer diameter of the needle decreases, i.e. 10 gauge is larger than 33 gauge. The same gauge tubing is available with different wall thicknesses resulting in different inner diameters. Hamilton designates the thick wall version of the tubing by adding an “s” to the gauge. For example, 26s is the thick walled version of 26 gauge tubing. To see the dimensions of the tubing Hamilton uses for needles, turn to the Gauge Index on page 119.

Considerations for Syringes

250 μ L and Smaller

For syringes 250 μ L and smaller it is recommended to use the “s” gauge tubing and a Cemented or Removable Needle. With small volume syringes the needle dead volume becomes critical. If the dead volume is too large it will be difficult to prime the syringe. If a thick walled version of the desired gauge is not available or if a Luer Lock hub is desired, special priming techniques may be required. Ideally the dead volume will not exceed 20% of the syringe’s nominal dispense volume.

What is Dead Volume?

Dead volume is defined as the volume of solution that remains in the needle after an injection. To achieve a precise dispense the dead volume must be completely primed with sample by rapidly filling and dispensing until the air bubbles are flushed from the system. Once primed the dead volume does not contribute to the volume aspirated or dispensed by the syringe.



Choosing the Appropriate Gauge (Cont.)

Calculating Needle Dead Volume

The dead volume and dimensions of the needle tubing are listed in the Gauge Index (page 119). The dead volume can be calculated by the equation $(\text{inner diameter}/2)^2(\pi)(\text{needle length})$. Add this to the dead volume of the needle hub to get the needle's total dead volume. For a Metal or Kel-F Luer Lock Needle connected to a Hamilton syringe add 10 μL , and for a Removable Needle there is no additional dead volume.

Considerations for Syringes 500 μL and Larger

For syringes of this size, flow rate and backpressure are the biggest considerations. It is possible to use a 27 gauge and smaller needle with these syringes. However, the force to press the plunger will increase, and the dispense rate must be slow. When possible, it is always recommended to use the thin-walled tubing in lieu of the "s" gauge tubing.

Small Gauge Needle Bending with Length

As needle diameter decreases, the needle becomes less rigid. For applications that require a small gauge needle but still need rigidity for penetration, it is recommended to order the shortest needle that is still suitable for the application. The Neuros syringe on page 58 may also be an option. It has a protective sleeve to improve the rigidity of a small gauge needle.

Using 34 Gauge Needles

A 34 gauge needle is significantly smaller than a 33 gauge needle. For some applications the smaller size is a real advantage but has inherent complications. 34 gauge tubing requires special cutting tools to ensure the tubing is not crimped shut. Due to this limitation the needles are only available in restricted lengths and point styles. The small inner diameter (ID) results in a needle more prone to clogging, and cleaning wires are not available for this size. The small ID also makes it difficult to aspirate water with a fitted Microliter syringe; therefore, a Gastight syringe must be used with a 34 gauge needle.

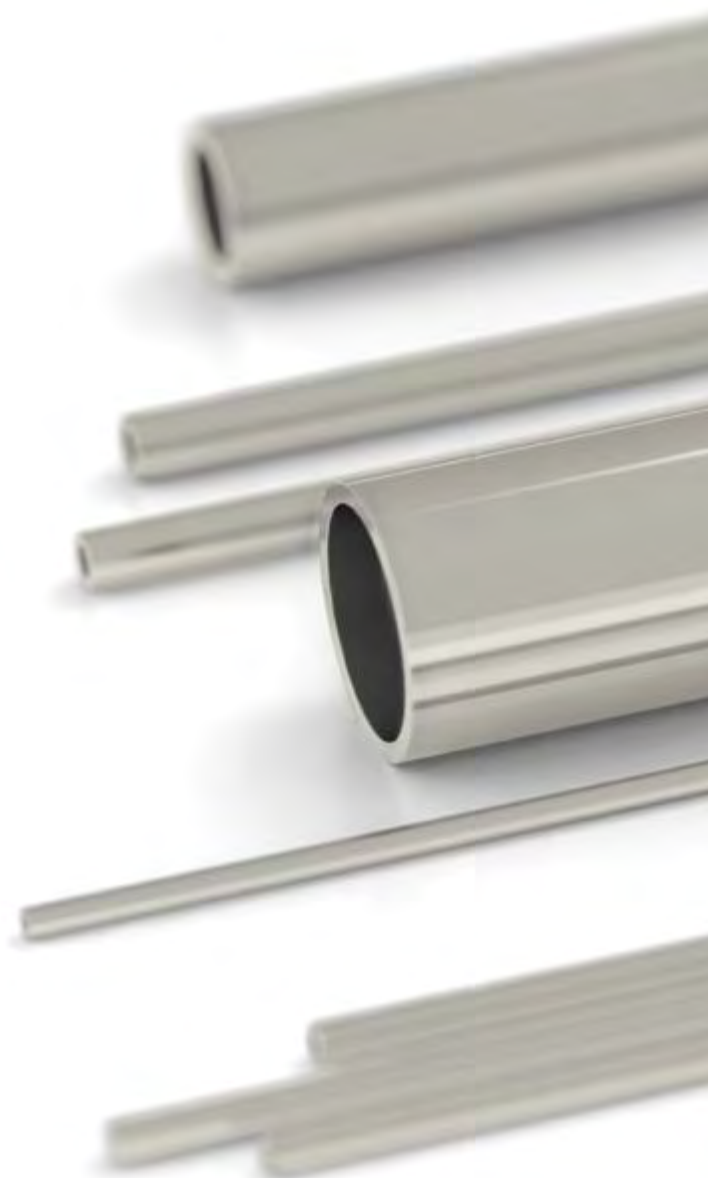



NEEDLES

Needles

Hamilton Company offers the widest variety of standard and custom needles in the industry. All needles are built from high quality materials including 304 stainless steel tubing to ensure chemical resistance. Custom needle part numbers are used to deliver all common gauge, length, and point style combinations with quick turnaround. For more complicated custom requests contact a Hamilton representative.





Luer Lock Needles

Metal and plastic hub needles designed to connect with industry standard Luer syringes and fittings.



Luer Lock Needles

P. 104

Removable Needles

For use with Hamilton Removable Needle Syringes to create a tight, low dead volume connection.

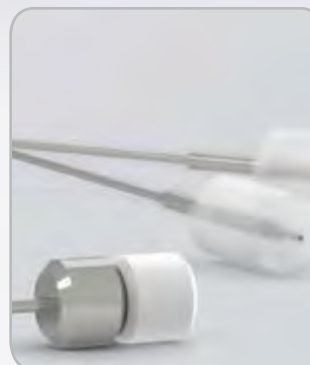

Removable Needles

P. 107

Specialty Needles

Application specific needle connections such as: cut tubing, glass micro pipettes, Thin-Layer Chromatography, Gel-Loading, PEEK, and Valve Port needles.



Specialty Needles

P. 110

Needle Cleaning Accessories

This section includes products for caring for the needles such as: a Needle Cleaning Kit, Cleaning Wires, and Cleaning Solution Concentrate.



Needle Cleaning Accessories

P. 113

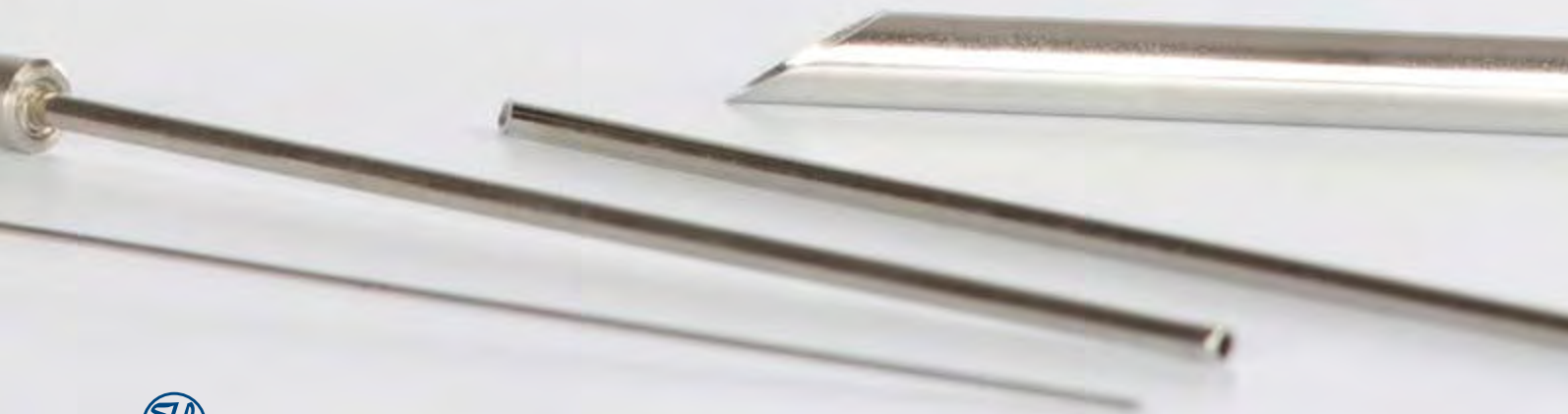



Luer Lock Needles

Hamilton Luer Lock Needles are designed to fit any standard Luer or Luer Lock syringe or fitting. They are specifically designed to minimize dead volume when connected with a Hamilton PTFE Luer Lock (TLL) or Luer Tip (LT) syringe.

Excessive dead volume can make it impossible to completely prime syringes smaller than 100 μL . Complete priming of the syringe and needle is critical to achieving the stated accuracy and precision.

Kel-F Hub Needles



P. 105

Metal Hub Needles



P. 106



Kel-F Hub Needles

The Kel-F hub is made from CTFE plastic. Needles are available from 31 to 10 gauge. This hub is recommended when connecting to a rigid male Luer like a Luer Tip (LT) syringe because the plastic is more pliable and creates the best seal. All needles are sold in six-packs and the standard needles are 51 mm long. For all custom needles, the length and point style will need to be specified prior to placing an order.



Standard Kel-F Hub Needles

Length	Gauge	Point 2	Point 3	Point 5
51 mm	31 ga	90131	90531	
	30 ga	90130	90530	
	29 ga	90129	90529	
	28 ga	90128	90528	
	27 ga	90127	90532	
	26s ga	90139	90539	7746-12
	26 ga	90126	90533	7746-10
	25 ga	90125	90525	7746-09
	24 ga	90124	90524	7746-08
	23 ga	90123	90523	7746-07
	22s ga	90138	90534	7746-11
	22 ga	90122	90134	7746-06
	21 ga	90121	90521	7746-05
	20 ga	90120	90520	7746-04
	19 ga	90119	90519	7746-13
	18 ga	90118	90535	7746-03
	17 ga	90117	90517	7746-02
	16 ga	90116	90516	7746-01
	15 ga	90115	90515	7746-14
	14 ga	90114	90514	7746-15
13 ga	90113	90513		
12 ga	90112	90512		
11 ga	90111	90511		
10 ga	90110	90536	7746-16	

Custom Kel-F Hub Needles

Length	Gauge	Point 2, 3, or 4	Point 5 or AS
10 – 304 mm	31 ga	7750-22	
	30 ga	7750-21	
	29 ga	7750-20	
	28 ga	7750-19	
	27 ga	7750-18	
	26s ga	7750-24	7752-19
	26 ga	7750-17	7752-17
	25s ga	7750-26	7752-21
	25 ga	7750-16	7752-16
	24 ga	7750-15	7752-15
	23s ga	7750-25	7752-20
	23 ga	7750-14	7752-14
	22s ga	7750-23	7752-18
	22 ga	7750-13	7752-13
	21 ga	7750-12	7752-12
	20 ga	7750-11	7752-11
	19 ga	7750-10	7752-10
	18 ga	7750-09	7752-09
	17 ga	7750-08	7752-08
	16 ga	7750-07	7752-07
15 ga	7750-06	7752-06	
14 ga	7750-05	7752-05	
13 ga	7750-04	7752-04	
12 ga	7750-03	7752-03	
11 ga	7750-02	7752-02	
10 ga	7750-01	7752-01	





Metal Hub Needles

The Metal hub is made from nickel plated brass. Needles are available from 33 to 10 gauge. This hub makes the most rigid connection to the needle making it perfect for repetitive septum piercing. Metal hub needles are compatible with PTFE Luer Lock (TLL) syringes. All needles are sold in six-packs and the standard needles are 51 mm long. For all custom needles, the length and point style will need to be specified prior to placing an order.



Standard Metal Hub Needles

Length	Gauge	Point 2	Point 3	Point 5
51 mm	33 ga	90033	91033	
	32 ga	90032	91032	
	31 ga	90031	91031	
	30 ga	90030	91030	
	29 ga	90029	91029	
	28 ga	90028	91028	
	27 ga	90027	91027	
	26s ga	90039	91039	7729-01
	26 ga	90026	91026	7729-03
	25s ga	90052		
	25 ga	90025	91025	7729-04
	24 ga	90024	91024	7729-05
	23 ga	90023	91023	7729-06
	22s ga	90038	91038	7729-02
	22 ga	90022	91022	7729-07
	21 ga	90021	91021	7729-08
	20 ga	90020	91020	7729-09
	19 ga	90019	91019	7729-14
	18 ga	90018	91018	7729-10
	17 ga	90017	91017	7729-11
	16 ga	90016	91016	7729-12
	15 ga	90015	91015	7729-13
	14 ga	90014	91014	7730-01
	13 ga	90013	91013	7730-02
	12 ga	90012	91012	7730-03
	11 ga	90011	91011	7730-04
	10 ga	90010	91010	7730-05

Custom Metal Hub Needles

Length	Gauge	Point 2, 3, or 4	Point 5 or AS
10 - 304 mm	33 ga	7747-01	
	32 ga	7747-02	
	31 ga	7748-17	
	30 ga	7748-16	
	29 ga	7748-15	
	28 ga	7748-14	
	27 ga	7748-13	
	26s ga	7748-19	7751-19
	26 ga	7748-12	7751-17
	25s ga	7748-21	7751-21
	25 ga	7748-11	7751-16
	24 ga	7748-10	7751-15
	23s ga	7748-20	7751-20
	23 ga	7748-09	7751-14
	22s ga	7748-18	7751-18
	22 ga	7748-08	7751-13
	21 ga	7748-07	7751-12
	20 ga	7748-06	7751-11
	19 ga	7748-05	7751-10
	18 ga	7748-04	7751-09
17 ga	7748-03	7751-08	
16 ga	7748-02	7751-07	
15 ga	7748-01	7751-06	
14 ga	7749-05	7751-05	
13 ga	7749-04	7751-04	
12 ga	7749-03	7751-03	
11 ga	7749-02	7751-02	
10 ga	7749-01	7751-01	



Point Styles





Removable Needles

Hamilton Removable Needles provide the benefits of a replaceable needle with the smallest dead volume necessary for complete priming of the syringe. The unique connection installs the needle precisely at the zero line and the compression seal between the glass barrel and the PTFE or CTFE seal is chemically inert.

Large Hub Removable Needles



P. 108

Small Hub Removable Needles



P. 109





Large Hub Removable Needles

The Large Hub Removable Needle (RN) is compatible with RN syringes from 250 µL to 10 mL and all SampleLock syringes. Needles are available from 26s to 20 gauge. All needles are sold in six-packs and the standard needles are 51 mm long. For all custom needles, the length and point style will need to be specified prior to placing an order.



Standard Large Hub RN Needles

Length	Gauge	Point 2	Point 3	Point 5
51 mm	26s ga	7779-02	7780-01	7784-03
	26 ga	7779-04	7780-02	7784-04
	22s ga	7779-03	7780-03	7784-01
	22 ga	7779-01	7780-04	7784-02

Custom Large Hub RN Needles

Length	Gauge	Point 2, 3, or 4	Point 5 or AS
10 - 304 mm	26s ga	7806-04	7732-04
	26 ga	7806-03	7732-03
	25s ga	7806-09	7732-09
	25 ga	7806-07	7732-05
	24 ga	7806-06	7732-07
	23s ga	7806-08	7732-08
	23 ga	7806-05	7732-06
	22s ga	7806-02	7732-02
	22 ga	7806-01	7732-01
	21 ga	7806-11	7732-11
	20 ga	7806-10	7732-10



Point Styles



Small Hub Removable Needles

The Small Hub Removable Needle (RN) is compatible with RN syringes from 2.5 µL to 100 µL. Needles are available from 34 to 18 gauge. All needles are sold in six-packs and the standard needles are 51 mm long. For all custom needles, the length and point style will need to be specified prior to placing an order.



Standard Small Hub RN Needles

Length	Gauge	Point 2	Point 3	Point 5
38 mm	33 ga		7762-06	
	32 ga		7762-05	
	31 ga		7762-04	
	30 ga		7762-03	
	28 ga		7762-02	
51 mm	27 ga		7762-01	
	26s ga	7758-02	7768-01	7784-07
	26 ga	7758-04	7768-02	7784-08
	22s ga	7758-03	7770-01	7784-05
	22 ga	7758-01	7770-02	7784-06

Custom Small Hub RN Needles

Length	Gauge	Point 2, 3, or 4	Point 5 or AS
10 – 304 mm	34 ga	207434*	
	33 ga	7803-05	
	32 ga	7803-04	
	31 ga	7803-03	
	30 ga	7803-07	
	29 ga	7803-06	
	28 ga	7803-02	
	27 ga	7803-01	
	26s ga	7804-04	7731-02
	26 ga	7804-03	7731-01
	25s ga	7804-10	7731-06
	25 ga	7804-05	7731-05
	24 ga	7804-08	7731-09
	23s ga	7804-09	7731-08
	23 ga	7804-07	7731-07
	22s ga	7804-02	7731-04
	22 ga	7804-01	7731-03
21 ga	7804-12	7731-11	
20 ga	7804-11	7731-10	
19 ga	207419	7731-13	
18 ga	7804-06	7731-12	

* Only available as a point style 3 or 4





Specialty Needles

Stainless Steel Tubing



P. 110

Glass Micro Pipettes



P. 111

Thin-Layer Chromatography Needles



P. 111

Gel-Loading Needles



P. 112

PEEK Needles



P. 112

Valve Port Needles



P. 112

Stainless Steel Tubing

Hamilton offers raw tubing cut to length or pointed needle cannulas without a hub. The raw tubing is sold by the centimeter and is snipped to length with no additional cleaning or processing. Needle cannulas are sold in six-packs that are processed and cleaned the same as a standard needle assembly.



Stainless Steel Tubing



Gauge	Cut Tubing	Point 2, 3, or 4	Point 5 or AS
33 ga	21033A	22033-01	
32 ga	21032A	22032-01	
31 ga	21031A	22031-01	
30 ga	21030A	22030-01	

Stainless Steel Tubing (Cont.)

Stainless Steel Tubing (Cont.)

Gauge	Cut Tubing	Point 2, 3, or 4	Point 5 or AS
29 ga	21029A	22029-01	
28 ga	21028A	22028-01	
27 ga	21027A	22027-01	
26s ga	21039A	22039-01	22039-02
26 ga	21026A	22026-01	22026-02
25s ga	21058A	22058-01	22058-02
25 ga	21025A	22025-01	22025-02
24 ga	21024A	22024-01	22024-02
23s ga	21041A	22041-01	22041-02
23 ga	21023A	22023-01	22023-02
22s ga	21038A	22038-01	22038-02
22 ga	21022A	22022-01	22022-02

Gauge	Cut Tubing	Point 2, 3, or 4	Point 5 or AS
21 ga	21021A	22021-01	22021-02
20 ga	21020A	22020-01	22020-02
19 ga	21019A	22019-01	22019-02
18 ga	21018A	22018-01	22018-02
17 ga	21017A	22017-01	22017-02
16 ga	21016A	22016-01	22016-02
15 ga	21015A	22015-01	22015-02
14 ga	21014A	22014-01	22014-02
13 ga	21013A	22013-01	22013-02
12 ga	21012A	22012-01	22012-02
11 ga	21011A	22011-01	22011-02
10 ga	21010A	22010-01	22010-02

Glass Micro Pipettes

Glass micro pipettes are widely used in Neuroscience because the point can be pulled to an incredibly small diameter and maintain the rigidity to penetrate tissue. Additionally, the dispense orifice exits from the very tip of the needle so the wound track can be minimized. The 1 mm RN compression fitting allows for quick connection to standard 1 mm capillary glass. Pull your own needle and attach it to an RN syringe without wax or glue.

1 mm Compression Fitting



P/N	Description
55750-01	RN Compression Fitting 1 mm

Hamilton does not offer 1 mm glass capillary tubing.

Thin-Layer Chromatography (TLC) Needles

TLC needles are custom blunt point needles made for use with RN Syringes. To improve reproducibility the first 19 mm of the needle point are coated with PTFE paint. This nonstick surface is applied to the outside of the tubing and improves precision by minimizing the chance of liquid sticking to the outside of the needle.

PTFE Coated TLC Needles

P/N	Gauge	Hub	Length
8646-02	26s ga	Small Hub RN	19 to 165 mm
8646-03	22s ga	Small Hub RN	19 to 165 mm
8646-01	22 ga	Large Hub RN	19 to 165 mm
8646-05	22 ga	Small Hub RN	19 to 165 mm



Gel-Loading Needles

These are replacement needles for a Fixed or Adjustable Gel-Loading syringes. The needles are available in a variety of outer diameters for compatibility with different sized loading wells. For more information on Gel-Loading Syringes turn to page 64.

Replacement Gel-Loading Needles



Syringe Type	Needle OD	Quantity	Part Number
Fixed Gel-Loading Syringe	0.2 mm	6 pk	8651-01
	0.3 mm	6 pk	8651-02
	0.4 mm	6 pk	8651-03
Adjustable Gel-Loading Syringe	0.2 mm	4 pk	78633
	0.3 mm	4 pk	78631

PEEK Needles

Some applications call for a non-metallic needle. These plastic needles are made from PEEK HPLC tubing that is both chemically and physical robust. PEEK needles are sold in six-packs.

PEEK Needles



P/N	Hub	Length	Outer Diameter	Inner Diameter
8649-01	Kel-F	51 mm	1.6 mm	0.8 mm
8650-01	Large RN	51 mm	1.6 mm	0.8 mm

Valve Port Needles

Hat type needles are designed to be connected directly to a flat bottom valve port. Use the needle bushing part number 35056 to connect the needle directly to any 1/4"-28 Hamilton valve. Hat needles are sold in three-packs.

Hat Needles



Length	Gauge	Point 2, 3, or 4
10 - 304 mm	26 gauge	90826
	25 gauge	90825
	24 gauge	90824
	23 gauge	90823
	22 gauge	90822
	21 gauge	90821
	20 gauge	90820
	19 gauge	90819
	18 gauge	90818
	17 gauge	90817
	16 gauge	90816
	15 gauge	90815
14 gauge	90814	



Point Styles





Needle Cleaning Accessories

To extend the life of a needle it is critical to thoroughly clean before storage. It is much easier to flush out contaminants before they dry and harden. Be sure to flush the needle with a solvent known to solubilize the sample. One common mistake is to flush salts, protein, or DNA with organic solvents. This tends to precipitate the contaminants, resulting in clogs instead of preventing them.

Hamilton's Needle Cleaning Kit includes a biodegradable, non-phosphate Cleaning Solution Concentrate that is suitable for many common sample types and various sized tungsten cleaning wires that can be threaded through the needle to clear a blockage.

Needle Cleaning Kit

P/N	Volume
76620A	Kit includes 10 of each wire and 70 mL of concentrate

Cleaning Solution Concentrate

P/N	Volume
18311	500 mL
18310	70 mL

Tungsten Cleaning Wires

P/N	For Gauges	Wire OD	Package
18304	22, 23 ga, and larger	0.306 mm	10 pk
18303	24 – 26 ga	0.207 mm	10 pk
18302	27 ga	0.167 mm	10 pk
18301	22s, 25s, and 28 – 30 ga	0.126 mm	10 pk
18300	26s and 31 – 33 ga	0.089 mm	10 pk
18306	23s ga	0.076 mm	10 pk





Needle Technical Reference

The Needle Technical Reference section includes information on the operation, maintenance, and dimensions of the needles. The information is intended as a general guideline.

For specific details on a part number or application search the part on our website or contact a local Hamilton representative.

Needle Care and Use

P. 115

Sterilization and Disinfection

P. 118

Gauge Index

P. 119





Needle Care and Use

Step 1

Inspection

Inspect the sealing surfaces

Inspect the connection between the needle hub and the syringe termination. Confirm that the sealing surfaces are free of major damage, scratches, or chips that could hinder sealing.

This is the sealing surface. Make sure there are no cracks, chips, obstructions, or damage.

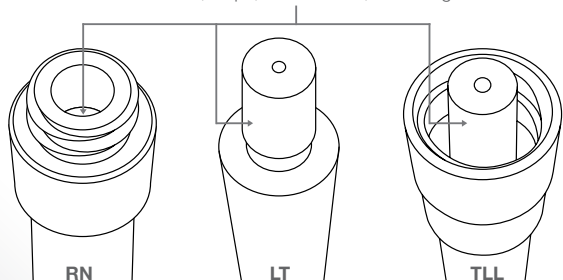

Remove cleaning wire

Hamilton 27 – 33 gauge needles ship with cleaning wires installed in the needle tubing. Be sure to remove this wire prior to installing the needle. In one hand grab the needle by the hub and in the other hand grab the cleaning wire. Gently pull the cleaning wire until it is completely removed from the needle tubing. Discard the used cleaning wire.

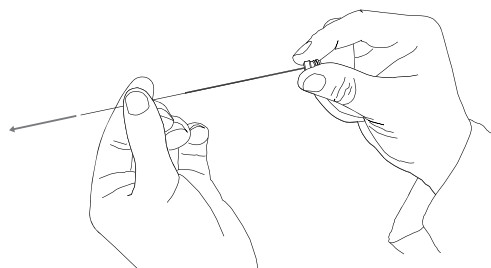

Step 2

Installation

Removable Needle Syringes

Remove the nut of the syringe, then insert the needle into the syringe hub. Thread the nut over the needle, and tighten onto the syringe. Make sure this connection is finger-tight to make a leak-free seal.

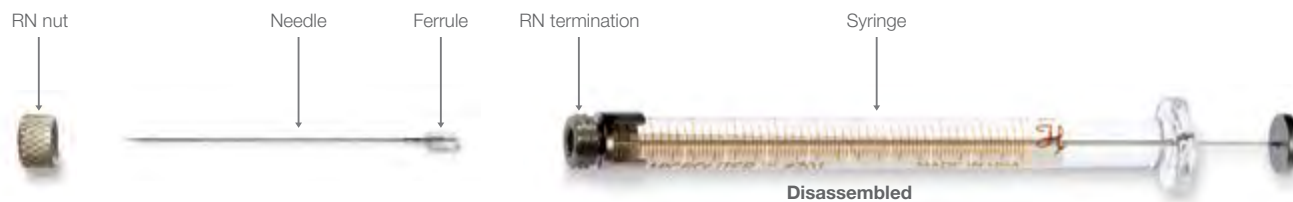

After placing the needle and ferrule into the RN hub, thread the RN nut over them and tighten onto the syringe.



Needle Care and Use (Cont.)

Installation (Cont.)

Luer Tip Syringes

Press the Kel-F needle hub onto the ground glass Luer Tip (LT) termination, and rotate slightly to ensure a tight seal.

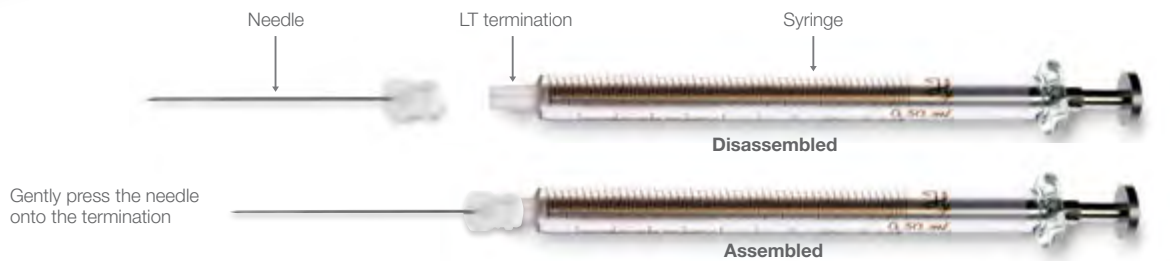

PFTE Luer Lock Syringes

Press the Metal or Kel-F needle hub onto the PTFE Luer Lock (TLL) termination until the threads engage. Rotate the hub clockwise. The threads will pull the hub onto the termination resulting in a tight seal.

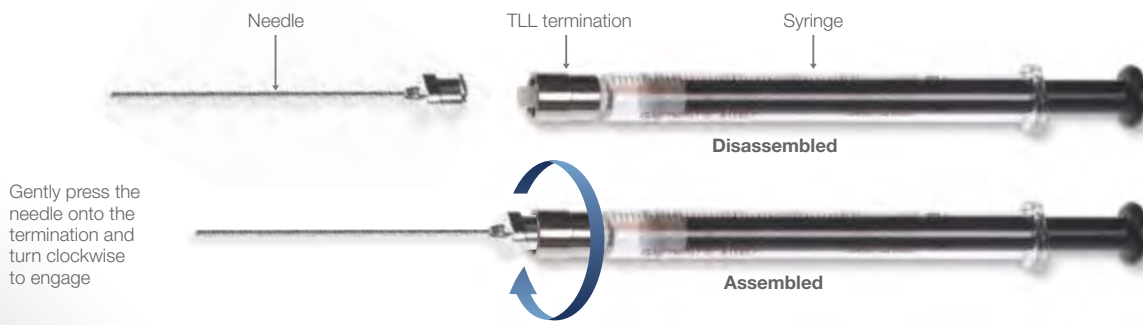

Step 3

Priming

If dead volume is less than 20% of the syringe volume

When priming, the needle should be immersed in the sample. Rapidly draw and dispense sample into the syringe until bubbles are no longer visible in the syringe barrel. For larger syringes it is possible to remove air bubbles by turning the barrel upright and allowing the air bubbles to rise to the needle exit. Then dispense the air bubbles from the needle.

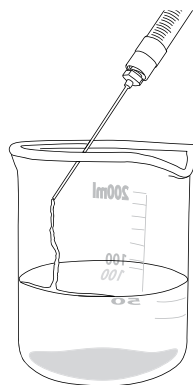

If dead volume is greater than 20% of the syringe volume

With such a large dead volume it may not be possible to prime the syringe with the above method. In this case backfilling the system may be the best option. For this method the plunger is removed from the syringe and a second syringe is used to load sample from the back of the syringe. Once the system is completely primed, the plunger is reinserted and ready for use. For these instances Hamilton offers a Priming Kit which is shown on page 63.

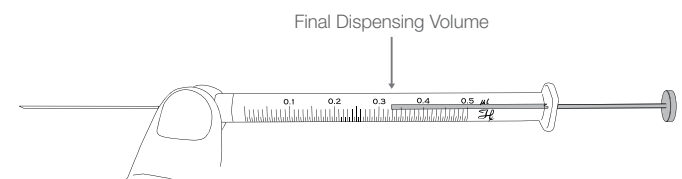

Needle Care and Use (Cont.)

Step 4

Cleaning

Immediately after use

After each use it is critical to flush the sample from the needle. If the sample contained dissolved particles it is critical to use a solvent known to dissolve the particles. For example, if the sample contains proteins, DNA, or salts then flushing with an organic solvent could precipitate these particles resulting in a clog. In this case it is better to flush with a detergent like Hamilton Cleaning Solution Concentrate (page 113), then with deionized water, and finally with acetone to ensure the needle dries quickly.

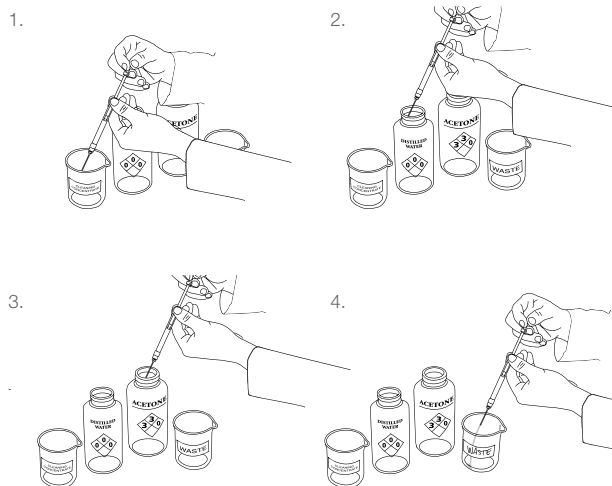

Step 5

Storage

After the needle is cleaned according to Step 4, store the needle with the syringe in the syringe packaging or in the original needle packaging to keep it protected and clean for future applications.

After a needle has become clogged

If the needle is clogged and it is not possible to flush with cleaning solution it is time to use the cleaning wires. Start with the smallest cleaning wire that can be pushed through the needle inner diameter. Slowly increase the cleaning wire up to the size specified for the needle gauge. Once the clog has been removed, rinse the needle as described above.

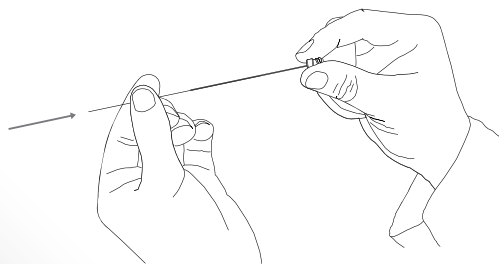



Sterilization and Disinfection

The table below shows the autoclavability of our needles as well as the recommended chemicals for disinfection. As an alternative to the autoclave, all needle types may be sterilized using ethylene oxide.

Sterilization and Disinfection Table

Product	Autoclave Sterilization	Chemical Disinfection ¹
Removable Needles	Yes	Yes
Metal Hub Needles	Yes	Yes
Kel-F Hub Needles	Yes	Yes
PTFE Tubing	Yes	Yes
Kel-F Fittings	Yes	Yes

¹Recommended disinfecting chemicals are Microcide SQ® (P/N 3995-01), 10% bleach, acetone, or ethanol.





Gauge Index

The Gauge Index contains the nominal inner and outer dimensions of the tubing used in Hamilton needles. If the needle dead volume exceeds 20% of the nominal syringe volume then special priming steps may be required. The index lists the dead volume in $\mu\text{L}/\text{cm}$ so it is easier to determine if the gauge is suitable for the desired syringe volume.

Gauge Index

Gauge	Nominal OD	Nominal ID	Volume
34	0.159 mm	0.051 mm	0.02 $\mu\text{L}/\text{cm}$
33	0.210 mm	0.108 mm	0.09 $\mu\text{L}/\text{cm}$
32	0.235 mm	0.108 mm	0.09 $\mu\text{L}/\text{cm}$
31	0.261 mm	0.133 mm	0.14 $\mu\text{L}/\text{cm}$
30	0.312 mm	0.159 mm	0.20 $\mu\text{L}/\text{cm}$
29	0.337 mm	0.184 mm	0.27 $\mu\text{L}/\text{cm}$
28	0.362 mm	0.184 mm	0.27 $\mu\text{L}/\text{cm}$
27	0.413 mm	0.210 mm	0.35 $\mu\text{L}/\text{cm}$
26s	0.474 mm	0.127 mm	0.13 $\mu\text{L}/\text{cm}$
26	0.464 mm	0.26 mm	0.53 $\mu\text{L}/\text{cm}$
25s	0.515 mm	0.153 mm	0.18 $\mu\text{L}/\text{cm}$
25	0.515 mm	0.260 mm	0.53 $\mu\text{L}/\text{cm}$
24	0.566 mm	0.311 mm	0.76 $\mu\text{L}/\text{cm}$
23s	0.642 mm	0.116 mm	0.11 $\mu\text{L}/\text{cm}$
23	0.642 mm	0.337 mm	0.89 $\mu\text{L}/\text{cm}$
22s	0.718 mm	0.152 mm	0.18 $\mu\text{L}/\text{cm}$
22	0.718 mm	0.413 mm	1.34 $\mu\text{L}/\text{cm}$
21	0.819 mm	0.514 mm	2.07 $\mu\text{L}/\text{cm}$
20	0.908 mm	0.603 mm	2.86 $\mu\text{L}/\text{cm}$
19	1.07 mm	0.686 mm	3.70 $\mu\text{L}/\text{cm}$
18	1.27 mm	0.838 mm	5.52 $\mu\text{L}/\text{cm}$
17	1.47 mm	1.07 mm	8.94 $\mu\text{L}/\text{cm}$
16	1.65 mm	1.19 mm	11.2 $\mu\text{L}/\text{cm}$
15	1.83 mm	1.37 mm	14.8 $\mu\text{L}/\text{cm}$
14	2.11 mm	1.80 mm	25.6 $\mu\text{L}/\text{cm}$
13	2.41 mm	1.80 mm	25.6 $\mu\text{L}/\text{cm}$
12	2.77 mm	2.16 mm	36.6 $\mu\text{L}/\text{cm}$
11	3.05 mm	2.39 mm	44.8 $\mu\text{L}/\text{cm}$
10	3.40 mm	2.69 mm	57.0 $\mu\text{L}/\text{cm}$





INDEX

Index

0160310.....	35	17891.....	84	203085.....	35	209683.....	51
1117-01.....	83	17893.....	84	203086.....	51	209684.....	51
1117-02.....	83	18005.....	84	203141.....	51	209685.....	51
1117-03.....	83	18007.....	84	203181.....	51	209686.....	51
1120-01.....	83	18053.....	84	203182.....	51	21030A.....	110
1122-01.....	83	18054.....	84	203185.....	50	21031A.....	110
1160-01.....	83	18300.....	72, 113	203189.....	50	21032A.....	110
1161-01.....	83	18301.....	72, 113	203194.....	35	21033A.....	110
1161-02.....	83	18302.....	72, 113	203197.....	50	22010-01.....	111
1162-01.....	83	18303.....	72, 113	203198.....	50	22010-02.....	111
1162-02.....	83	18304.....	72, 113	203205.....	50	22011-01.....	111
1162-03.....	83	18306.....	72, 113	203206.....	50	22011-02.....	111
1169-01.....	83	18310.....	72, 113	203209.....	50	22012-01.....	111
13205.....	83	18311.....	72, 113	203219.....	50	22012-02.....	111
13230.....	83	200740.....	50	203225.....	50	22013-01.....	111
13231.....	83	200742.....	50	203226.....	50	22013-02.....	111
13269.....	83	201050.....	36	203235.....	35	22014-01.....	111
13271.....	83	202192.....	37, 38	203274.....	35	22014-02.....	111
13272.....	83	202630.....	52	203349.....	35	22015-01.....	111
1359-01.....	83	202640.....	52	203361.....	50	22015-02.....	111
1360-01.....	83	202643.....	52	203362.....	50	22016-01.....	111
14700.....	69	202660.....	49, 53	203363.....	50	22016-02.....	111
14725.....	69	202668.....	35	203560.....	34	22017-01.....	111
14806.....	70	202880.....	49	203566.....	34	22017-02.....	111
14906.....	70	203043.....	50	204000.....	53	22018-01.....	111
159902.....	38	203073.....	35	204001.....	53	22018-02.....	111
16160.....	84	203074.....	50	204051.....	53	22019-01.....	111
16161.....	84	203075.....	35	204052.....	53	22019-02.....	111
17187.....	84	203076.....	50	204379.....	35	22020-01.....	111
17188.....	84	203077.....	35	204400.....	35	22020-02.....	111
17190.....	84	203078.....	50	204452.....	35	22021-01.....	111
17191.....	84	203079.....	35	204475.....	35	22021-02.....	111
17192.....	84	203080.....	50	204880.....	71	22022-01.....	111
17193.....	84	203081.....	35	207419.....	109	22022-02.....	111
17887.....	84	203082.....	51	207434.....	62, 109	22023-01.....	111
17888.....	84	203083.....	35	209681.....	51	22023-02.....	111
17890.....	84	203084.....	51	209682.....	51	22024-01.....	111





22024-02	111	32188	83	65461-02	59	7657-01	21, 35, 54
22025-01	111	32189	83	67430-01	50	7658-01	21, 54
22025-02	111	32190	83	67434-01	50	7659-01	23
22026-01	111	32191	83	67436-01	50	7660-01	23
22026-02	111	32193	83	67438-01	50	7661-01	23
22027-01	111	35080	73	67440-01	50	76620A	72, 113
22028-01	111	35081	73	67442-01	34	7662-01	23
22029-01	111	35083	73	67444-01	34	7663-01	23
22030-01	110	4871-01	83	67446-01	34	7729-01	106
22031-01	110	52343-01	83	67448-01	34	7729-02	106
22032-01	110	54658-01	37	67450-01	34	7729-03	106
22033-01	110	54659-01	37	67452-01	34	7729-04	106
22038-01	111	54660-01	37	67454-01	50	7729-05	106
22038-02	111	54661-01	37	75810	74	7729-06	106
22039-01	111	54662-01	37	7632-01	17, 61	7729-07	106
22039-02	111	55750-01	62, 111	7633-01	61	7729-08	106
22041-01	111	55751-01	63	7634-01	18, 61	7729-09	106
22041-02	111	62161-01	37	7635-01	18, 61	7729-10	106
22058-01	111	65457-01	59	7636-01	18, 61	7729-11	106
22058-02	111	65457-02	59	7637-01	18, 61	7729-12	106
31335	74	65458-01	59	7638-01	18, 61	7729-13	106
32117	82	65458-02	59	7639-01	18	7729-14	106
32120	82	65459-01	59	7640-01	18	7730-01	106
32123	82	65459-02	59	7641-01	19	7730-02	106
32126	82	65460-01	59	7642-01	19	7730-03	106
32129	82	65460-02	59	7643-01	19	7730-04	106
32134	82	65460-03	59	7644-01	19	7730-05	106
32135	82, 83	65460-04	59	7645-01	19	7731-01	109
32146	69	65460-05	59	7646-01	19	7731-02	109
32150	82	65460-06	59	7649-01	24, 54	7731-03	109
32151	82	65460-10	59	7650-01	24, 54	7731-04	109
32165	82	65460-11	59	7651-01	24, 54	7731-05	109
32166	82	65460-15	59	7652-01	24, 54	7731-06	109
32168	82	65460-16	59	7653-01	17, 21, 54, 61	7731-07	109
32169	82	65460-20	59	7654-01	21, 35, 54, 61	7731-08	109
32175	83	65460-21	59	7655-01	21, 54, 61	7731-09	109
32187	83	65461-01	59	7656-01	21, 36, 54, 61	7731-10	109





INDEX

7731-11	109	7748-09	106	7750-23	105	7752-16	105
7731-12	109	7748-10	106	7750-24	105	7752-17	105
7731-13	109	7748-11	106	7750-25	105	7752-18	105
7732-01	108	7748-12	106	7750-26	105	7752-19	105
7732-02	108	7748-13	106	7751-01	106	7752-20	105
7732-03	108	7748-14	106	7751-02	106	7752-21	105
7732-04	108	7748-15	106	7751-03	106	7758-01	109
7732-05	108	7748-16	106	7751-04	106	7758-02	109
7732-06	108	7748-17	106	7751-05	106	7758-03	109
7732-07	108	7748-18	106	7751-06	106	7758-04	109
7732-08	108	7748-19	106	7751-07	106	7762-01	109
7732-09	108	7748-20	106	7751-08	106	7762-02	109
7732-10	108	7748-21	106	7751-09	106	7762-03	109
7732-11	108	7749-01	106	7751-10	106	7762-04	109
7746-01	105	7749-02	106	7751-11	106	7762-05	109
7746-02	105	7749-03	106	7751-12	106	7762-06	109
7746-03	105	7749-04	106	7751-13	106	7768-01	109
7746-04	105	7749-05	106	7751-14	106	7768-02	109
7746-05	105	7750-01	105	7751-15	106	7770-01	109
7746-06	105	7750-02	105	7751-16	106	7770-02	109
7746-07	105	7750-03	105	7751-17	106	7779-01	108
7746-08	105	7750-04	105	7751-18	106	7779-02	108
7746-09	105	7750-05	105	7751-19	106	7779-03	108
7746-10	105	7750-06	105	7751-20	106	7779-04	108
7746-11	105	7750-07	105	7751-21	106	7780-01	108
7746-12	105	7750-08	105	7752-01	105	7780-02	108
7746-13	105	7750-09	105	7752-02	105	7780-03	108
7746-14	105	7750-10	105	7752-03	105	7780-04	108
7746-15	105	7750-11	105	7752-04	105	7784-01	108
7746-16	105	7750-12	105	7752-05	105	7784-02	108
7747-01	106	7750-13	105	7752-06	105	7784-03	108
7747-02	106	7750-14	105	7752-07	105	7784-04	108
7748-01	106	7750-15	105	7752-08	105	7784-05	109
7748-02	106	7750-16	105	7752-09	105	7784-06	109
7748-03	106	7750-17	105	7752-10	105	7784-07	109
7748-04	106	7750-18	105	7752-11	105	7784-08	109
7748-05	106	7750-19	105	7752-12	105	7803-01	62, 109
7748-06	106	7750-20	105	7752-13	105	7803-02	62, 109
7748-07	106	7750-21	105	7752-14	105	7803-03	62, 109
7748-08	106	7750-22	105	7752-15	105	7803-04	62, 109





7803-05	62, 109	80075.....	21	80338	45	80630	18, 41
7803-06	62, 109	80079.....	46, 48	80339	17, 49	80639	18
7803-07	62, 109	80080	46, 48	80342	49	80660	55
7804-01	62, 109	80081	65	80350	17	80665	18, 31
7804-02	62, 109	80085	21	80351	43	80700.....	18, 41
7804-03	62, 109	80087	46, 48	80357	46, 48	80701	18
7804-04	62, 109	80088	46, 48	80358	46, 48	80708.....	18
7804-05	62, 109	80089	46, 48	80359	46, 48	80730.....	18, 41
7804-06	109	80091	65	80365	17, 31	80739.....	18
7804-07	62, 109	80094	46, 48	80366	17, 45	80765.....	18, 31
7804-08	62, 109	80096	46, 48	80383	17	80770.....	55
7804-09	62, 109	80100.....	19, 61	80384	17	80800	18, 41
7804-10.....	62, 109	80104.....	70	80386	43	80801	18
7804-11	109	80107	70	80387.....	46, 48	80808	18
7804-12.....	109	80108.....	19	80388	46, 48	80830	18, 41
7806-01	108	80135.....	19, 41	80389	46, 48	80839	18
7806-02	108	80175	46	80390	46, 48	80865	18, 31
7806-03	108	80176	46, 48	80391.....	46, 48	80900	21, 41
7806-04	108	80200	21, 41	80393	46, 48	80901	22
7806-05.....	108	80201.....	22	80398	46	80908	21
7806-06	108	80208	21	80399	46	80920	22
7806-07	108	80222	22	80400	17, 41	80922	22
7806-08.....	108	80230	21, 41	80401.....	18	80930	21, 41
7806-09.....	108	80231.....	32	80408	17	80931.....	32
7806-10.....	108	80238	32	80430	18, 41	80938	32
7806-11	108	80239	21	80439	17	80939	21
78631.....	112	80250.....	54	80465	17, 31	80950	54
78633.....	65, 112	80262.....	22	80500	17, 41	80956	42
80000	21, 41, 45	80265	21, 31	80501.....	18	80962	22, 36
80001	22	80266	64	80508	17	80965	21, 31
80008	21	80275.....	21, 31	80521.....	17	80975.....	21, 31
80011	45	80285.....	21	80530	18, 41	80985	21, 31
80014.....	21	80300	17, 41, 45, 49	80539	17	81000.....	21, 41
80020	38	80301.....	18	80550	55	81001.....	22
80024.....	38	80308	17	80551.....	55	81008.....	21
80030	21, 41	80314.....	18	80565	17, 31	81020.....	22
80039	21	80318.....	53	80600	18, 41	81022.....	22
80050	54	80330	18, 41, 49, 52	80601	18	81030.....	21, 41
80062	22	80331.....	43	80608	18	81031	32
80065	21, 31	80336	18, 41	80621.....	18	81038.....	32





INDEX

81039.....	21	81316.....	24	81614.....	24	84856.....	19, 41
81041.....	64	81317.....	24	81616.....	24	84857.....	19, 41
81050.....	54	81318.....	70	81617.....	24	84858.....	19, 41
81056.....	42	81320.....	25	81618.....	70	84859.....	19, 41
81060.....	22	81324.....	70	81620.....	25	84861.....	19, 41
81062.....	22, 36	81330.....	24	81624.....	70	84875.....	23, 41
81065.....	21, 31	81331.....	32	81630.....	24	84877.....	23, 41
81075.....	21, 31	81341.....	64	81631.....	32	84878.....	23, 41
81085.....	21, 31	81343.....	24	81643.....	24	84880.....	23, 41
81100.....	21, 41	81356.....	42	81656.....	42	84881.....	23, 41
81101.....	22	81360.....	25, 36, 37	81660.....	25	84883.....	23, 41
81108.....	21	81365.....	24, 31	82520.....	25	84884.....	23, 41
81120.....	22	81401.....	25	82521.....	25	84886.....	23, 41
81122.....	22	81403.....	70	82570.....	42	84887.....	23, 41
81130.....	21, 41	81414.....	24	83700.....	75	84889.....	23, 41
81131.....	32	81416.....	24	84250.....	65	84980.....	32
81138.....	32	81417.....	24	84255.....	65	84983.....	32
81139.....	21	81418.....	70	84301.....	31	84986.....	32
81156.....	42	81420.....	25	84302.....	31	84989.....	32
81160.....	22	81424.....	70	84303.....	31	85020.....	25
81162.....	22, 36, 37	81430.....	24	84500.....	65	85021.....	25
81165.....	21, 31	81431.....	32	84501.....	65	86020.....	25
81175.....	21, 31	81441.....	64	84502.....	65	86200.....	19
81185.....	21, 31	81443.....	24	84503.....	65	86204.....	70
81201.....	22	81456.....	42	84504.....	65	86207.....	70
81214.....	21	81460.....	25, 36, 37, 38	84505.....	65	86211.....	19, 41
81216.....	21, 31	81501.....	25	84511.....	65	86250.....	19, 61
81217.....	21, 41	81514.....	24	84611.....	65	86252.....	70
81220.....	22	81516.....	24	84711.....	65	86254.....	70
81222.....	22	81517.....	24	84815.....	32	86257.....	19, 43
81230.....	21, 41	81518.....	70	84816.....	32	86258.....	84
81231.....	32	81520.....	25	84817.....	32	86259.....	19, 41
81242.....	64	81524.....	70	84818.....	32	86274.....	46, 48
81243.....	21	81530.....	24	84819.....	32	86276.....	46, 48
81256.....	42	81531.....	32	84850.....	19, 41	86311.....	25
81260.....	22, 36	81543.....	24	84851.....	19, 41	86312.....	25
81262.....	22, 36	81556.....	42	84852.....	19, 41	86313.....	25
81265.....	21, 31	81560.....	25	84853.....	19, 41	86314.....	25
81301.....	25	81570.....	42	84854.....	19, 41	86326.....	42
81314.....	24	81601.....	25	84855.....	19, 41	86336.....	42





86346	42	88407	70	90117	105	90539	105
8646-01	111	88411	19, 41	90118	105	90814	112
8646-02	111	88500	19	90119	105	90815	112
8646-03	111	88504	70	90120	105	90816	112
8646-05	111	88507	70	90121	105	90817	112
8649-01	112	88511	19, 41	90122	105	90818	112
8650-01	112	90010	106	90123	105	90819	112
8651-01	65, 112	90011	106	90124	105	90820	112
8651-02	65, 112	90012	106	90125	105	90821	112
8651-03	65, 112	90013	106	90126	105	90822	112
86580	74	90014	106	90127	105	90823	112
87402	43	90015	106	90128	105	90824	112
87404	43	90016	106	90129	105	90825	112
87405	43	90017	106	90130	105	90826	112
87900	17, 41, 45	90018	106	90131	105	91010	106
87908	17	90019	106	90134	105	91011	106
87919	17	90020	106	90138	105	91012	106
87930	18, 41, 52	90021	106	90139	105	91013	106
87931	18	90022	106	90511	105	91014	106
87942	17, 31	90023	106	90512	105	91015	106
87943	17, 31	90024	106	90513	105	91016	106
87957	46, 48	90025	106	90514	105	91017	106
87958	46, 48	90026	106	90515	105	91018	106
87959	46, 48	90027	106	90516	105	91019	106
87987	46, 48	90028	106	90517	105	91020	106
87988	46, 48	90029	106	90519	105	91021	106
87989	46, 48	90030	106	90520	105	91022	106
87990	46, 48	90031	106	90521	105	91023	106
87991	46	90032	106	90523	105	91024	106
87992	46	90033	106	90524	105	91025	106
87993	46, 48	90038	106	90525	105	91026	106
87994	46, 48	90039	106	90528	105	91027	106
88000	19	90052	106	90529	105	91028	106
88004	70	90110	105	90530	105	91029	106
88007	70	90111	105	90531	105	91030	106
88011	19, 41	90112	105	90532	105	91031	106
88035	52	90113	105	90533	105	91032	106
88040	52	90114	105	90534	105	91033	106
88400	19, 61	90115	105	90535	105	91038	106
88404	70	90116	105	90536	105	91039	106





INDEX

93898-01	52
PE 10	62
PE 20	62
PE 50	62
PRMKIT.....	63



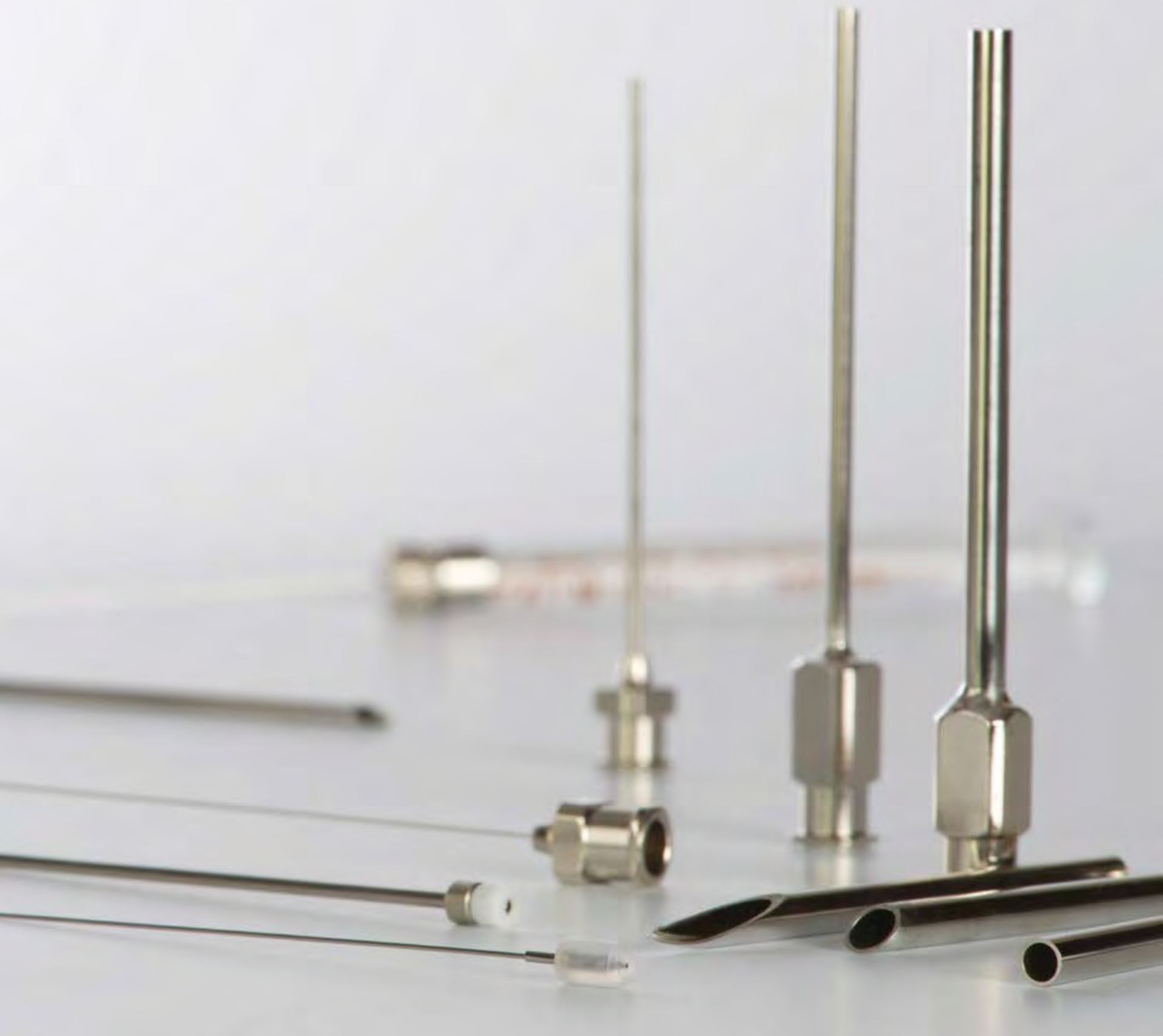

©2018 Hamilton Company. All rights reserved.
All other trademarks are owned and/or registered by Hamilton Company in the U.S. and/or other countries.
Lit. No. L20097 Rev. C – 04/2018

HAMILTON 

Web: www.hamiltoncompany.com
USA: 800-648-5950
Europe: +40-356-635-055

Hamilton Americas & Pacific Rim
Hamilton Company Inc.
4970 Energy Way
Reno, Nevada 89502 USA
Tel: +1-775-858-3000
Fax: +1-775-856-7259
sales@hamiltoncompany.com

Hamilton Europe, Asia & Africa
Hamilton Central Europe S.R.L.
str. Hamilton no. 2-4
307210 Giarmata, Romania
Tel: +40-356-635-055
Fax: +40-356-635-060
contact.lab.ro@hamilton-ce.com

To find a representative in your area, please visit hamiltoncompany.com/contacts.