

interscience

A top-down view of a petri dish containing a green agar medium. Several distinct microbial colonies are visible, including large, fluffy white and light blue ones, and smaller, more dense green ones. The colonies are scattered across the surface of the agar.

Catalog

Scientific equipment
for microbiology



interscience

- More than 45 years' experience in microbiology
- Complete range from sample preparation to bacterial analysis
- Products 100% designed and manufactured in France

SCIENTIFIC
EQUIPMENT
MANUFACTURER

MADE IN FRANCE



About us



**45 years
of microbiology
expertise**

Our mission is to design and manufacture great products to guarantee reliable and safe microbiological analyses. We serve the food, pharmaceutical, cosmetics, environmental and research sectors.

A FRENCH INTERNATIONAL COMPANY

 **180**
employees

 **7**
subsidiaries

 **80%**
export

 **50 000**
labs equipped

A FAMILY STORY

Brothers Emmanuel and Jules Jalenques run the family business founded in 1979 by their father François Jalenques. Starting out in a renovated 18th-century barn in the hamlet of Jalenques in the Cantal region of France, the company now has a worldwide presence, with sales offices, subsidiaries and a solid network of distributors in over 130 countries.



“Interscience has always been driven by innovation and scientific excellence.

It is also crucial for us to provide our users with responsive, high-quality services.”

Emmanuel and Jules Jalenques, Co-CEOs.

TEAMS AT YOUR SERVICE

We provide you with worldwide support with our:

- **Sales teams:** product demonstration, technical questions, price request
- **Microbiology Application teams:** testing in our laboratory, equipment installation and qualification
- **Customer Support teams:** technical assistance, equipment installation, troubleshooting and maintenance

DYNAMIC R&D

The R&D department, with over 30 employees and engineers, has filed over 70 patents since its creation. Its microbiology laboratory supports the development of innovative, high-performance products.



MADE IN FRANCE

All our products are designed and manufactured in the same factory, following a manufacturing ethic that ensures excellent quality products made from noble, durable materials.

- 95% of our spare parts suppliers are European, 80% of them French
- Each controller undergoes a series of endurance and manufacturing tests
- Manufacturer's warranty, maintenance contracts and extended warranties

An environmentally-friendly factory

100 %
energy autonomy

100 %
waste sorted

100 %
carbon-free energy

R&D center and factory, Puycapel, France



Food

Food safety represents a considerable challenge for food industries. Interscience offers a range of products for all your analyses (dairy products, meat, seafood, ready meals, etc.) in quality control and R&D.

The use of our products improves the quality and reliability of microbiological analyses by offering repeatability and reproducibility.

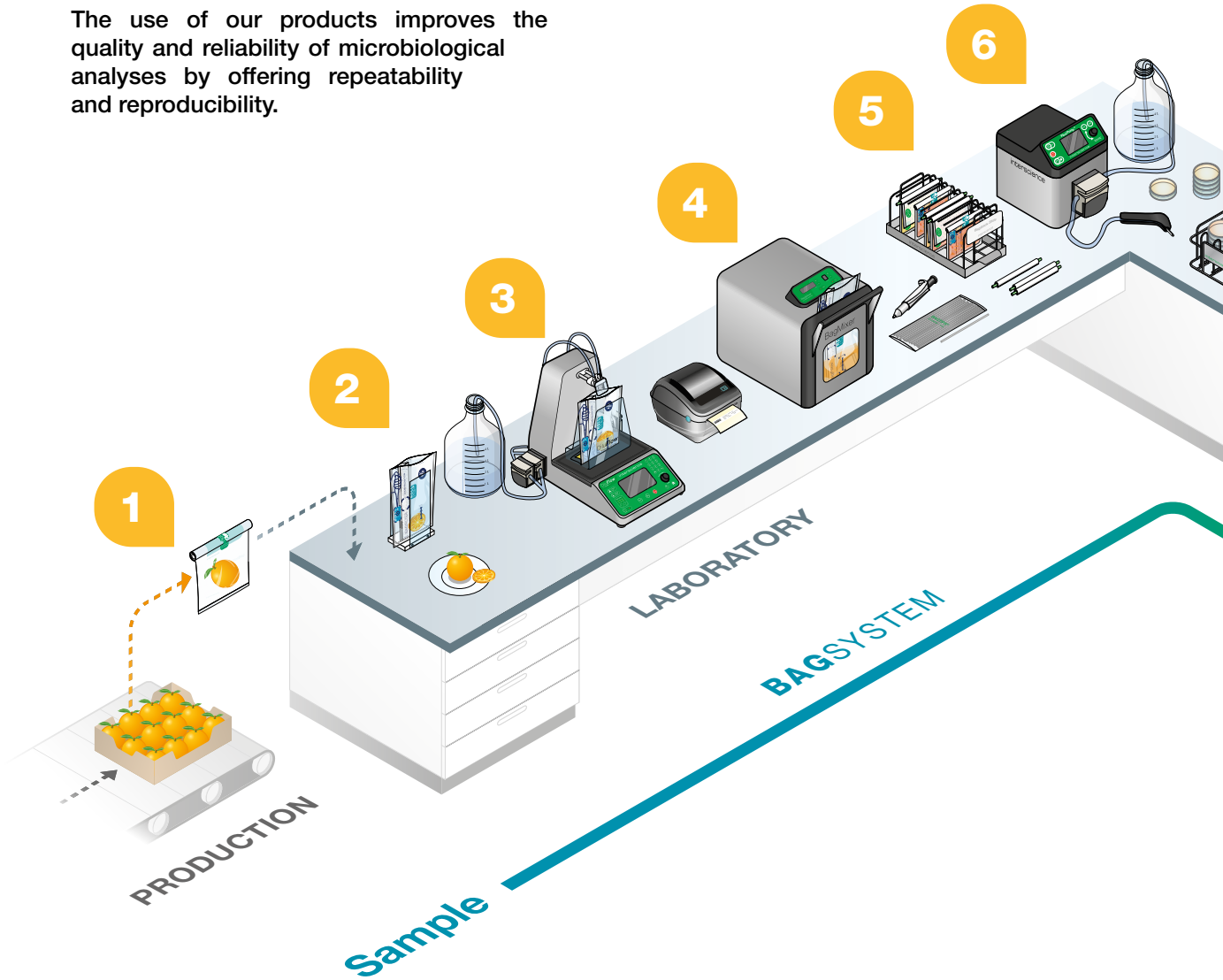

- 1** RollBag®
 › Collect the sample
 Sterile sampling bags p. 169
- 2** BagFilter® Pipet & Roll
 › Sample with a filter bag
 Blender bags with filter p. 146
- 3** DiluFlow® Elite 5 kg
 › Weighing and diluting the sample
 Gravimetric dilutors p. 23

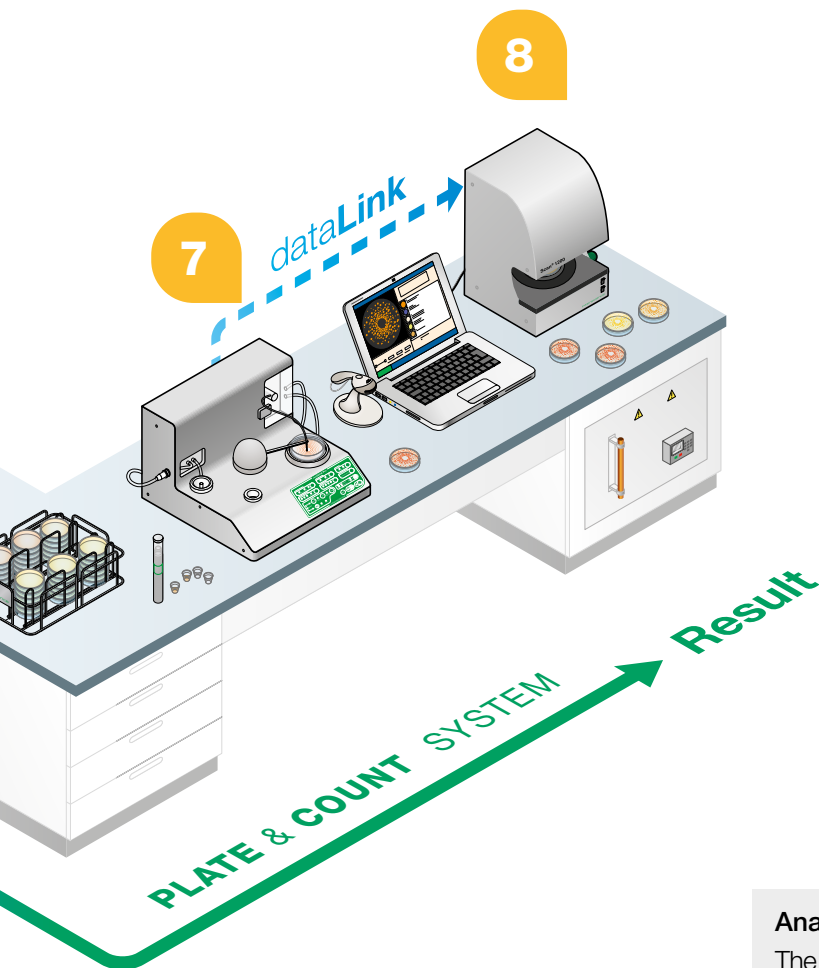

<p>4 BagMixer® SW › Homogenize the sample Lab blenders</p>	p. 47
<p>5 BagRack® Slide › Organize the samples Lab accessories</p>	p. 73
<p>6 FlexiPump® › Distribute culture media Dispensing pumps</p>	p. 59
<p>7 easySpiral® Pro › Automatically plate Automatic platers</p>	p. 93
<p>8 Scan® 1200 › Count Colony counters</p>	p. 115

Analysis of hygiene indicators

The number of viable organisms is an indicator of the hygiene state of the food product; it is an indicator of possible cross-contamination or high biomass. The enumeration gives the result of the bacteriological state of the environment and production conditions.

- Total flora / Mesophilic flora
- Lactic flora
- Enterobacteria
- Coliforms
- *Escherichia coli* β - glucuronidase positive
- *Pseudomonas aeruginosa*
- Yeasts & Molds
- *Bacillus cereus*

Research & Development

Various microbiological analyses of food product before it is placing on the market.

- Aging process study
- Process validation
- Fertility / Sterility tests
- Challenge test

Pathogen analysis

Testing for the presence of a possible pathogen responsible for infection in the product to determine whether it is safe for consumption.

- *Salmonella* spp.
- *Listeria monocytogenes*
- *Campylobacter* spp.

Food protocol by germ						
Microorganisms	<i>instaBag</i> [®] BPW	<i>instaBag</i> [®] Fraser ½	Dilu <i>Flow</i> [®]	BagMixer [®]	easySpiral [®]	Scan [®]
Total flora	✓	-	✓	✓	✓	✓
Lactic flora	✓	-	✓	✓	✓	✓
<i>Pseudomonas</i>	✓	-	✓	✓	✓	✓
Enterobacteria	✓	-	✓	✓	✓	✓
Coliforms	✓	-	✓	✓	✓	✓
<i>E. coli</i> β - glucuronidase +	✓	-	✓	✓	✓	✓
<i>Staphylococcus</i> coagulase +	✓	-	✓	✓	✓	✓
<i>Clostridium perfringens</i>	✓	-	✓	✓	-	✓
ARS to 46 °C	✓	-	✓	✓	-	✓
<i>Bacillus cereus</i>	✓	-	✓	✓	-	✓
<i>Campylobacter</i>	✓	-	✓	✓	-	-
Yeasts & Molds	✓	-	✓	✓	-	-
<i>Listeria monocytogenes</i>	-	✓	✓	✓	-	-
<i>Salmonella</i> spp.	✓	-	✓	✓	-	-

EXAMPLE OF PROTOCOL: 25 G TEST SAMPLE



Collect the sample with **RollBag**[®] sterile sampling bag.



Weigh 25 g of sample and dilute at 1/10th with Dilu*Flow*[®].



Homogenize the sample in a **BagMixer**[®] lab blender.



Plate quality indicators with easySpiral[®] automatic platers.



Enumerate colonies to obtain a compliance result with **Scan**[®] colony counter.



Pharmaceutical

In order to protect everyone's health, the pharmaceutical industry performs high volumes of microbiological analysis.

The use of our products helps to improve the quality and reliability of microbiological while respecting the requirements of the pharmacopoeia and the FDA (Food and Drug Administration). You will also improve your production management.

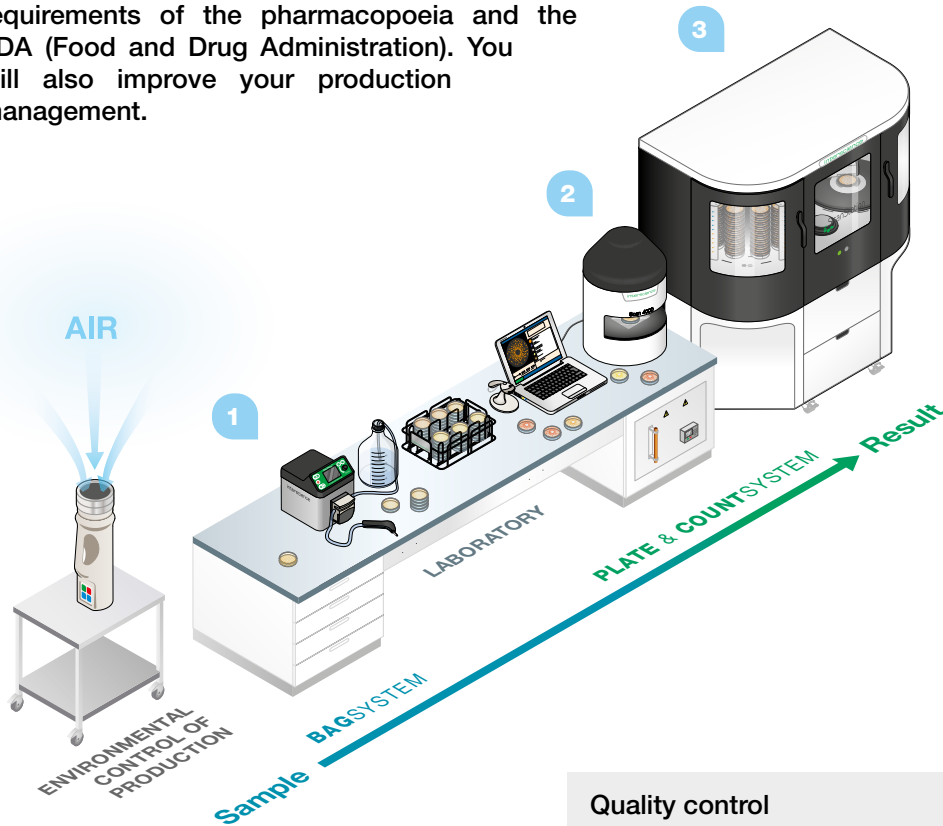

Industries

- 1 **FlexiPump®** › Distribute culture media
Dispensing pumps p. 59
- 2 **Scan® 4000** › Count the colonies
Colony counters p. 116
- 3 **ScanStation®** › Incubating and counting
Incubator and colony counter p. 124

Quality control

- Environmental monitoring
- Enumeration of finished products
- Detection of reference microorganisms:
Escherichia coli, *Staphylococcus aureus*,
Pseudomonas aeruginosa, *Aspergillus brasiliensis*, *Candida albicans*

Research & Development

- Various microbiological analyses of a pharmaceutical product before it is placed on the market.
- Study on aging
 - Validation process
 - Challenge test
 - Sterility test

EXAMPLE OF PROTOCOL: QUALITY CONTROL DURING PRODUCTION



Collect the sample with **RollBag®** sterile sampling bag.



Weigh and dilute 10 g of sample with **DiluFlow® Elite** 1 kg.



Homogenize in a **BagMixer®** or **MiniMix®** according to the test sample.



Plate with **easySpiral®** for micro-organism research.



Place the Petri dishes in **ScanStation®** for incubation.



Detect colonies for compliance with **ScanStation®**.



Cosmetic

The cosmetics industry must respond to the needs and requirements of their consumers and must be attentive to the environment and health.

The use of our products improves the quality and reliability of microbiological analyse. You will also get better production management.

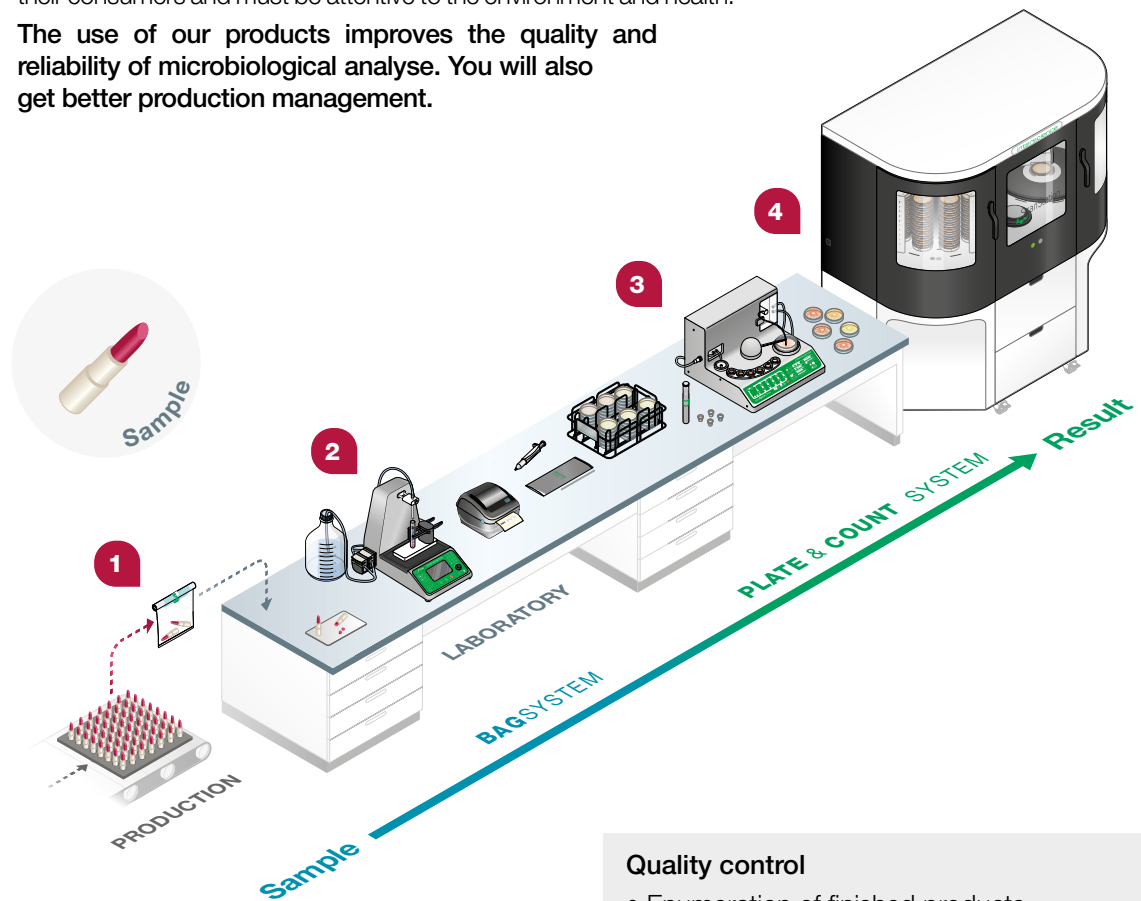

- 1 **RollBag®** › Collect Sterile sampling bags p. 169
- 2 **DiluFlow® Elite 1 kg** › Dilute Gravimetric dilutors p. 24
- 3 **easySpiral Dilute®** › Plate Automatic plater p. 95
- 4 **ScanStation®** › Incubate and count Incubator and colony counter p. 124

Quality control

- Enumeration of finished products
- Challenge test
- Enumeration of the 5 reference microorganisms: *Escherichia coli*, *Pseudomonas aeruginosa*, *Staphylococcus aureus*, *Aspergillus brasiliensis*, *Candida albicans*
- Environmental control (bioburden)

Research & Development

Various microbiological analyses of cosmetic product before it is placed on the market.

- Study of formulation
- Validation process
- Challenge test
- Study on aging

EXAMPLE OF PROTOCOL: CHALLENGE TEST IN R&D



Weigh and dilute to 1/10th 1 g of artificially contaminated sample in a tube with **DiluFlow® Elite 1 kg**.



Plate the sample with **easySpiral Dilute®** for the challenge test enumeration.



Place the Petri dishes in **ScanStation®** real-time incubator and colony counter.



Enumerate colonies to get an accurate result with **Scan®** or **ScanStation®**.



Environment

Microbiological analyses of our environment is essential for everyone's safety.

The Interscience range allows qualitative analyses of water, air, soil and the environment...

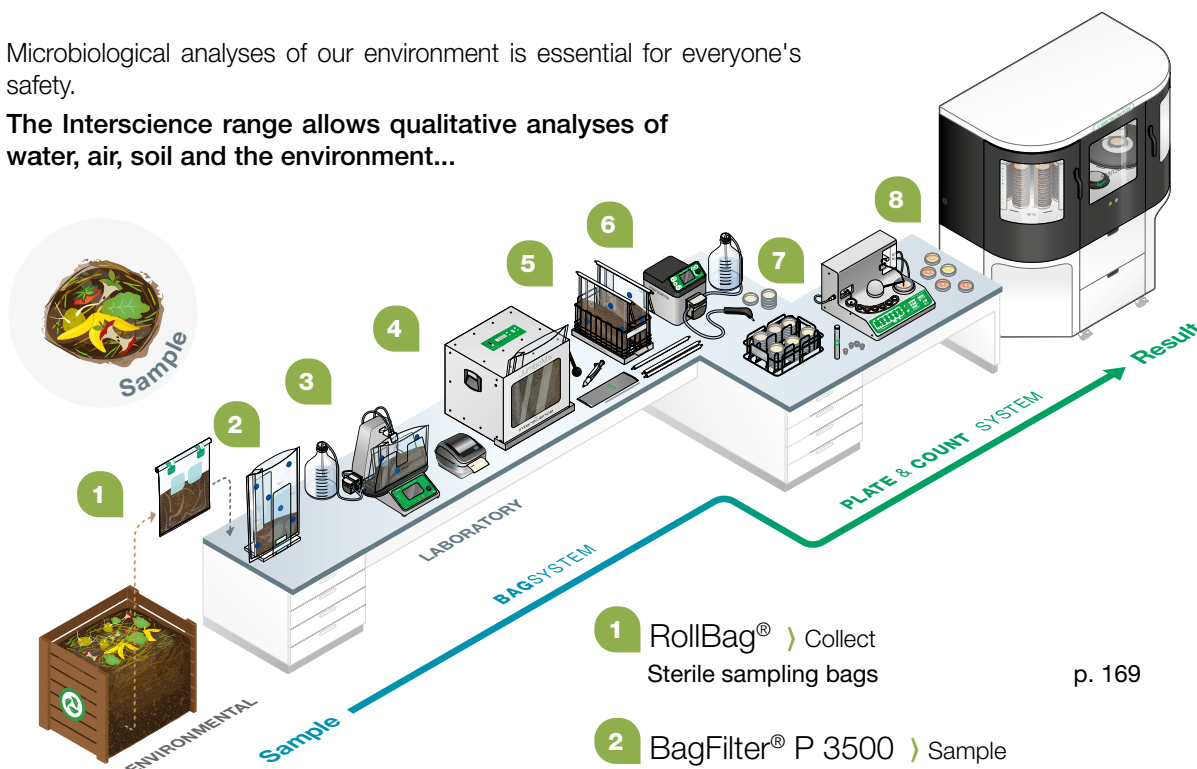

Quality control

- Water treatment, public water or sewage sludge enumeration: Total flora, *Escherichia coli*, Coliforms, *Legionella spp.*
- Search for microorganisms in soil and mud samples: *Pseudomonas spp.*, *Bacillus spp.*, anaerobic sulfite-reducing agent (*Clostridium spp.*), total and thermotolerant coliforms, antibiotic multi-resistant *Escherichia coli*
- Search for microorganisms in air samples: Sedimentation plating readings or in collector plating reading

Research & Development

- Hydrocarbon treatment
- Multiresistance to antibiotic analysis
- Physico-chemical soil analysis
- Aging study / plant analysis

- 1 RollBag®** › Collect Sterile sampling bags p. 169
- 2 BagFilter® P 3500** › Sample Blender bags with filter p. 144
- 3 DiluFlow® Pro** › Dilute Gravimetric dilutors p. 22
- 4 JumboMix® W CC** › Homogenize Lab blenders p. 50
- 5 BagRack® 3500** › Organize Lab accessories p. 74
- 6 FlexiPump®** › Distribute culture media Dispensing pumps p. 59
- 7 easySpiral Dilute®** › Plate Automatic plater p. 95
- 8 ScanStation®** › Incubate and count Incubator and colony counter p. 124

EXAMPLE OF PROTOCOL: MULTI-RESISTANCE ANALYSES (ATB in solid media)



Inoculate the strain to be analyzed with easySpiral® "Constant" mode and place the antibiotic discs before incubation.

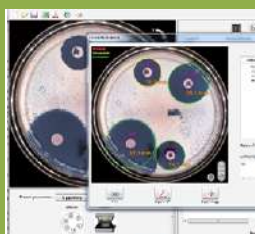

Read and interpret dishes (SIR) according to EUCAST, CASFM, CLSI... with the automatic Scan® range.



Veterinary

The animal health sector requires microbiological analyses and controls.
We offer a complete range from sampling to counting.

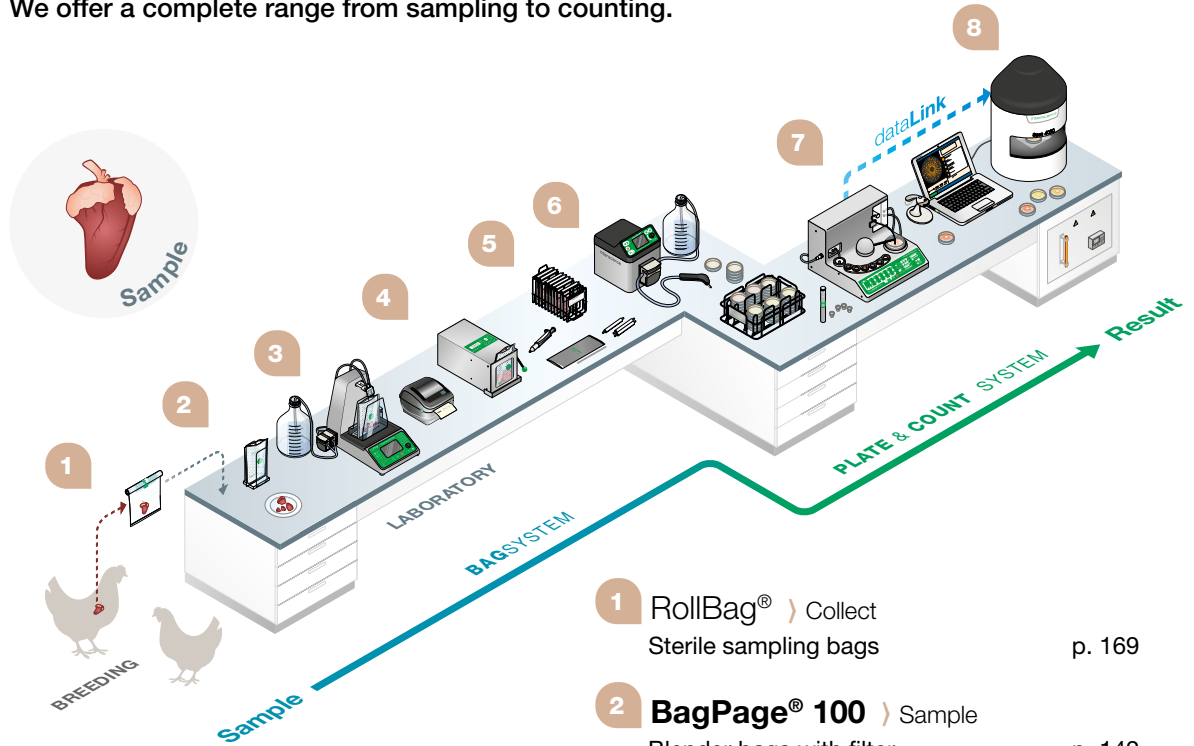

Animal health and R&D

- Biopsies
- Biological sampling
- Study of a bovine tuberculosis outbreak
- Antibiograms and antibiotic dosages in farming
- Enumeration of normal and infectious flora specimens

Veterinary industry

- Production quality control
- Challenge test
- Environment

- 1 RollBag®** } Collect Sterile sampling bags p. 169
- 2 BagPage® 100** } Sample Blender bags with filter p. 142
- 3 DiluFlow® Elite 1 kg** } Dilute Gravimetric dilutors p. 24
- 4 MiniMix®** } Homogenize Lab blenders p. 41
- 5 BagRack® 100** } Organize Lab accessories p. 74
- 6 FlexiPump®** } Distribute culture media Dispensing pumps p. 59
- 7 easySpiral Dilute®** } Plate Automatic platers p. 95
- 8 Scan® 4000** } Count Colony counters p. 116

EXAMPLE OF PROTOCOL: MICROBIOLOGICAL ANALYSIS OF A BIOPSY



Collect the sample with **RollBag®** sterile sampling bag.



Weigh 10 g biopsy sample and dilute with **DiluFlow® Elite** 1 kg.



Homogenize and filter the sample in a **MiniMix®**.



Plate the filtrate with **easySpiral Dilute®**.



Place the Petri dishes in **ScanStation®** for incubation.



Count the colonies using **ScanStation®** for diagnosis.



Public Research

Public research, being multidisciplinary, carries out microbiological analyses in different fields. Interscience offers a complete range of products to ensure the quality and safety of these analyses.

Our products enable us to respond to innovation and research projects of new concepts.

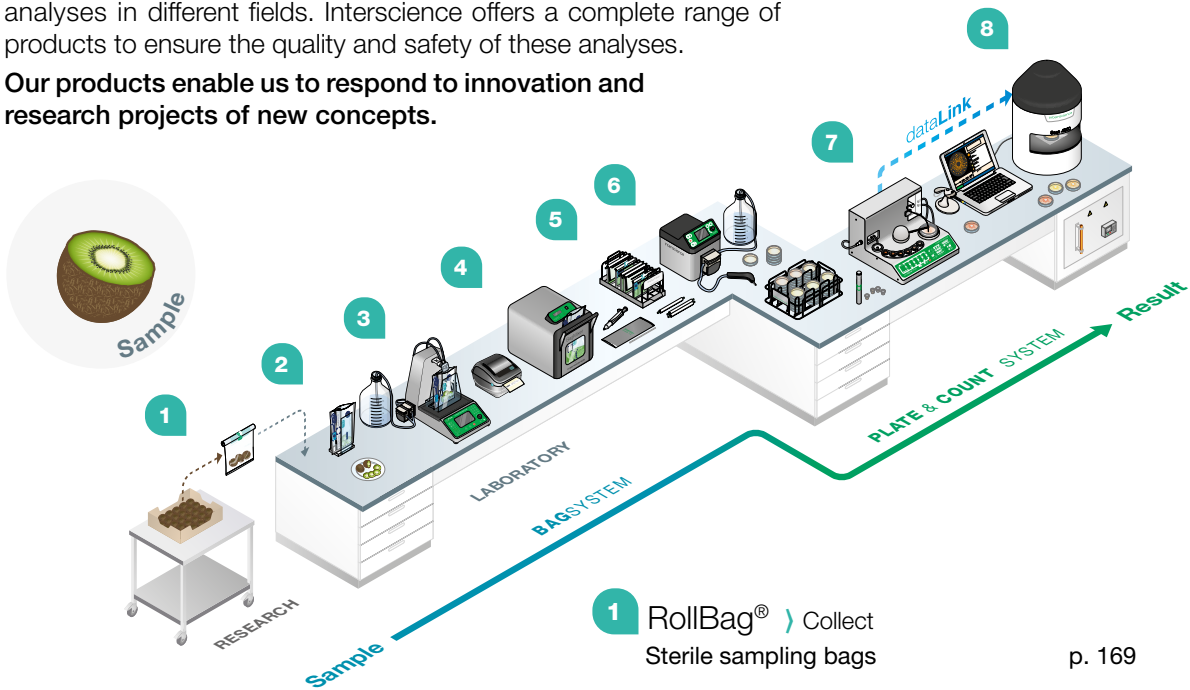

Public institute research in food

- Quality indicator research
- Pathogen research
- Aging process study
- Process validation

Public institute research in environmental

- Hydrocarbon treatment
- Multiresistance to antibiotic analysis
- Water treatment, public water or sewage sludge enumeration

Public institute research in animal and human health

- Microbials - Biological sampling
- Study of infectious contamination outbreak
- Antibigrams, antibiotic dosages and multiresistance to antibiotics
- Enumeration of normal and infectious flora specimens

- 1 RollBag®** › Collect
Sterile sampling bags p. 169
- 2 BagFilter® Pipet & Roll** › Sample
Blender bags with filter p. 146
- 3 DiluFlow® Elite 5 kg** › Dilute
Gravimetric dilutors p. 23
- 4 BagMixer® SW** › Homogenize
Lab blenders p. 47
- 5 BagRack® Slide** › Organize
Lab accessories p. 73
- 6 FlexiPump®** › Distribute culture media
Dispensing pumps p. 59
- 7 easySpiral Dilute®** › Plate
Automatic platers p. 95
- 8 Scan® 4000** › Count
Colony counters p. 116

EXAMPLE OF PROTOCOL: QUALITY CONTROL IN THE FOOD INDUSTRY



Collect the sample with **RollBag®** sterile sampling bag.



Weigh 25 g of sample and dilute 1/10th with **DiluFlow®**.



Homogenize the sample in a **BagMixer®** lab blender.



Plate quality indicators with **easySpiral®** automatic platers.



Place the Petri dishes for incubation in **ScanStation®**.



Counting using **ScanStation®** for a compliance result.



Comparison of manual and automatic

The study below shows a comparison between the manual method and the Interscience automated method, using the same microbial sample. The use of an automated method for the analysis of samples increases not only reproducibility but also productivity and reduces the use of consumables up to 75%. It ensures repeatability and complete traceability.

Comparison of manual and automatic methods

AUTOMATIC METHOD

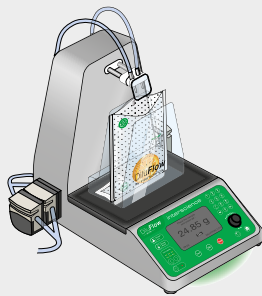
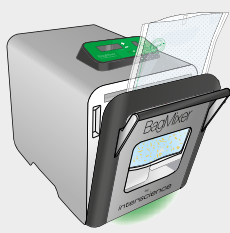
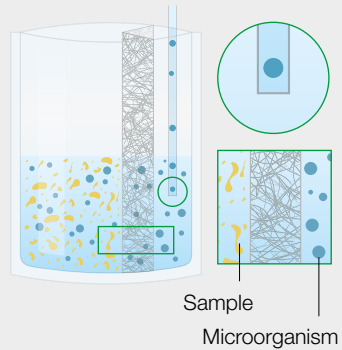

+

GRAVIMETRIC DILUTORS	LAB BLENDERS	FILTER BAGS FOR LAB BLENDERS
 <ul style="list-style-type: none"> Fast: 225 mL in 8 s Dilution accuracy: > 99%⁽¹⁾ Reproducible Secure Automatic traceability 	 <ul style="list-style-type: none"> Time saving on cleaning Filtration and blending No cross-contamination Optimal bacterial extraction 	 <p>Sample Microorganism</p> <ul style="list-style-type: none"> Instantaneous filtration: separation of microorganisms and samples in seconds Easy pipetting
		

1. Dilute the sample	2. Blend the sample	3. Collect the filtrate
----------------------	---------------------	-------------------------

-

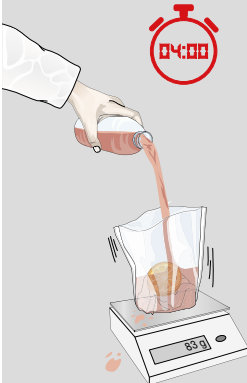
MANUAL METHOD

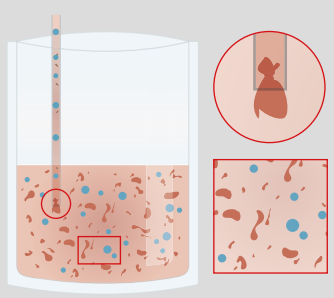
 <ul style="list-style-type: none"> Long and tedious Lack of precision Not reproducible Lack of security Manual traceability 	 <ul style="list-style-type: none"> Time consuming cleaning No filtration Cross-contamination Undesirable cell lysis 	 <ul style="list-style-type: none"> No filtration: sample + microorganisms to be decanted Blocked pipet
MANUAL DILUTION	SAMPLE GRINDING	BAG WITHOUT FILTER

(1) in Standard or Accurate mode (under optimal conditions)

methods in microbiology



Average duration of an analysis with the automatic method

75%

savings in consumables

AUTOMATIC PLATERS

- From 100 to 1×10^7 CFU/mL on a single Petri dish
- Up to 75% savings in consumables
- Automatic traceability

AUTOMATIC COUNTERS

- Simplified counting with the use of a filter bag
- Standardized and reproducible results⁽²⁾
- Results exported and archived automatically

Total duration

Comparison of manual and automatic methods

4. Dilute and plate the sample

5. Count the colonies

MANUAL PLATING

- Method with repetitive actions: 4 dilutions + 4 successive inoculations
- Many consumables
- Manual traceability

MANUAL COUNTING

- Difficult to count with the use of bag without filter
- Variable and uncertain results⁽²⁾
- Results entered manually: error-prone and time-consuming

Total duration

(2) study carried out on *Bacillus cereus*, *Escherichia coli* and *Lactobacillus casei*.

Sample preparation with BagSystem®

BagSystem® is a complete range of equipment and accessories for sample preparation for microbiological and biochemical as well as physico-chemical analyses. Compared to manual preparation, BagSystem® allows the automation of these steps while providing more **accurate results** and an **excellent reproducibility**. **Risks of cross-contamination are eliminated** and you can considerably **increase your analyses capacities**.

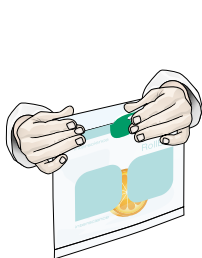

1. Collect

Collect the sample in the field or in production in a sterile bag **RollBag®**. The integrated sticker allows a resistant and **tight closure**.

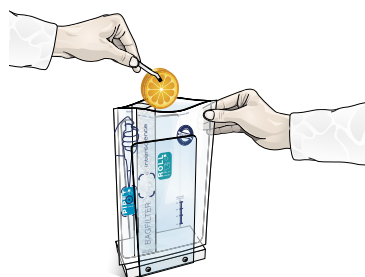

2. Sampling

Place the sample of interest in a bag either with or without a filter. A **single bag** avoids cross-contamination. With a filter bag, **filtration is carried out during blending**.

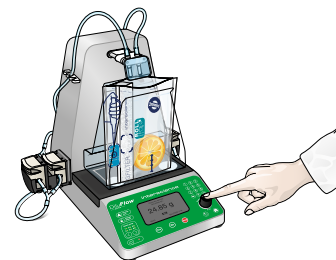

3. Dilute

Using the **DiluFlow®** gravimetric dilutor, weigh the test sample and dilute automatically according to the required dilution factor. **DiluFlow®** provides **accuracy, repeatability** and **traceability**.



4. Homogenize

The mother suspension is blended with a **BagMixer®**. A microbial extraction is extracted during the blending process **without any risk of cross-contamination**.

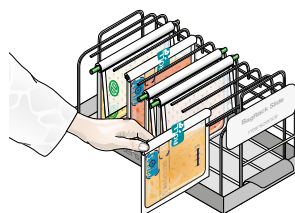

5. Organize

Bags are then closed and stored in **BagRack® Slide** by sliding them on to the side. Storage is hygienic and optimized for cadenced pipetting. It prevents risks of Musculoskeletal disorders.

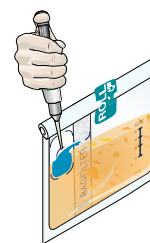

6. Pipet the filtrate

Pipet the sample easily thanks to the pipetting area, positioned at the bottom of the bag, and the integrated filter. No debris blocks the pipet or distorts the count on the Petri dish.

The filtrated sample is ready for analysis either with the traditional method or with the Plate & Count system® rapid analysis method.

7. Dispense liquids

Prepare media (in test tubes, bottles and Petri dishes) using **FlexiPump®** peristaltic pumps. Serial dispensing is accurate, fast and traceable.

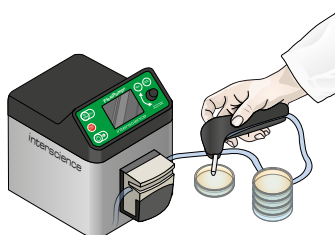

JumboLine®

JumboLine® is a product range for the preparation of all types of samples weighing up to 375 g. It is suitable for samples > 100 g in the analyses of milk powder, chocolate, soil, etc. for the detection of *E. coli* O157:H7, *Trichinella*, *Salmonella* spp., *Cryptosporidium* and *Giardia*. **JumboLine®** is particularly suitable for the detection of pathogens via a PCR method.



DiluFlow®
+ **Jumbokit**
Gravimetric dilutor

2 models :
DiluFlow® Elite
DiluFlow® Pro

JumboMix®
+ **JumboStand**
Lab blender

3 models :
JumboMix® 3500 P CC
JumboMix® 3500 W CC
JumboMix® 3500
WarmMix® CC

BagTools®, lab accessories



BagOpen® 3500
Bag opener/holder



BagClip® 3500
Closing clip



BagRack® 3500
Storage rack for bags



BagPipet®
Fixed-volume pipet

Bags designed for large samples



RollBag®
Sterile sampling bag
3 models:
25x38 / 25x50 / 38x56



BagFilter® P
Lateral filter bag
2 models:
2000 / 3500



BagPage® +
Full-page filter bag
2 models:
2000 / 3500



BagLight®
Bag without filter
2 models:
2000 / 3500



Food



Environmental



Public research



Gravimetric dilutors

The best solution for your dilutions!

DiluFlow® gravimetric dilutors automate the dilution of the sample before blending and add reliability to the process.



Top features of the range

Connectivity and full traceability⁽¹⁾

Traceability is ensured by a bidirectional LIMS ethernet connection. The data analysis is exported.

GeckoGrip holding system

This system replaces adhesive putty and keeps the analysis bag glue-free.

PATENTED

Robotic arm and protective plate⁽¹⁾

Easily place the sample in the analysis bag without risk of contamination.



High accuracy⁽¹⁾

An accurate dilution of all sample types from 1 to 20 g (at 1/10th) with an accuracy of > 99%.

Ultra-low profile

Widest possible opening for the bag and lowest loading threshold on the market!

Removable drip tray

Avoid tedious cleaning of the device.

PATENTED

(1) Valid according to the model, refer to the technical specifications.



Range overview



DiluFlow®	DiluFlow® Pro	DiluFlow® Elite 5 kg	DiluFlow® Elite 1 kg
Gravimetric dilutor 3 kg	Gravimetric dilutor 5 kg	Gravimetric dilutor 5 kg	Gravimetric dilutor 1 kg
Tech must-have	Best-seller	Full traceability	Designed for pharmaceuticals and cosmetics

	Top features			
Ultra-low profile	✓	✓	✓	✓
Drip tray	✓	✓	✓	✓
Robotic arm	-	✓	✓	✓
Jumbo kit option	-	✓	✓	-
Programmable	-	-	✓	✓
Full traceability	-	-	✓	✓
Up to 6 pumps	-	-	✓	✓
Multi-dispensing	-	-	✓	✓



DiluFlow®

Gravimetric dilutor 3 kg

Tech must-have

Ref. 501 103 (single pump)

Ref. 501 203 (double pump)



Gravimetric dilutors

The DiluFlow® automatically dilutes a solid sample in seconds, with the appropriate weight of diluent, and all traceability is guaranteed.

MAIN FEATURES

- **Dispensing time for 225 mL: < 10 s**
- **Dilution factor: 1/2 to 1/99**
- **Dilution accuracy: > 99%** (in Standard or Accurate mode in optimal conditions)
- **Max weight: 3000 g**

APPLICATIONS

The DiluFlow® gravimetric dilutor is used for sample preparation for microbiological analysis. It allows for a 25 g sample to be diluted to 1/10th in peptone water for the research of quality indicators or for enrichment in the detection of pathogens.



Food



Environmental



Public research



DiluFlow® Pro

Gravimetric dilutor 5 kg

Best-seller

Ref. 502 105 (single pump)
Ref. 502 205 (double pump)



The DiluFlow® Pro automatically dilutes a solid sample in seconds, with the appropriate weight of diluent, up to a total weight of 5 kg. Its robotic arm enables easy work under a laminar flow cabinet.



THE ESSENTIAL: TWICE AS FAST AND ACCURATE

Booster kit
Ref. 511 000

For more information, please refer to page 31

MAIN FEATURES

- Dispensing time for 225 mL: < 10 s
- Dilution factor: 1/2 to 1/99
- Dilution accuracy: > 99% (in Standard or Accurate mode in optimal conditions)
- Max weight: 5000 g



Food



Environmental



Public research

APPLICATIONS

The DiluFlow® Pro gravimetric dilutor is used for sample preparation for microbiological analysis. It is adapted to the sample pooling protocol and allows a sample weight of up to 375 g diluted to 1/10th with the Jumbo kit and is also adapted to the preparation protocol for PCR analysis. It also allows the weighing of 25 g for the research of quality indicators.

DiluFlow® Elite 5 kg



Gravimetric dilutor 5 kg

Full traceability

Ref. 503 105 (single pump)

Ref. 503 205 (double pump)

Gravimetric dilutors



The DiluFlow® Elite 5 kg automatically dilutes a solid sample, with the appropriate weight of diluent, up to a total weight of 5 kg. Its full traceability enables all operations to be recorded. Programmable and connectable to up to 6 diluents, it offers the best solution to dilute all types of samples.



SAMPLE SIZE > 100 G

Jumbo kit - Ref. 505 006

Booster kit - Ref. 511 000

For more information, please refer to page 30

MAIN FEATURES

- Dispensing time for 225 mL: < 9 s
- Dilution factor: 1/2 to 1/1000, customizable fractions
- Dilution accuracy: > 99% (in Standard or Accurate mode in optimal conditions)
- Max weight: 5000 g
- Max number of pumps: 2 integrated + 4 external

APPLICATIONS

The DiluFlow® Elite 5 kg gravimetric dilutor is used for sample preparation for microbiological analysis. It allows the preparation of low aW samples according to ISO 6887 standard, which consists in distributing a part of the diluent before weighing, ranging from 25 to 375 g, to avoid osmotic shock of the microorganisms. A second part of diluent is added in order to finalize the dilution precisely. It also allows the weighing of 25 g for the research of quality indicators.



Food



Environmental



Public research



DiluFlow® Elite 1 kg

Gravimetric dilutor 1 kg

Designed for pharmaceutical and cosmetics

Ref. 503 101 (single pump)

Ref. 503 201 (double pump)



The DiluFlow® Elite 1 kg automatically dilutes a solid sample in seconds, with the appropriate weight of diluent, up to a total weight of 1000 g. It offers the best solution to prepare your samples in the pharmaceutical and cosmetic industries, as well as animal health. Its full traceability enables the recording of all operations.



COSMETIC PACK:

Tongs platform - Ref. 505 003

Adjustable distribution system - Ref. 505 005

Dispensing assembly (GL45 - Ø 3.2 mm) - Ref. 513 045

For more information, please refer to page 30



Pharmaceutical



Cosmetics



Veterinary



Public research

MAIN FEATURES

- Dispensing time for 225 mL: < 9 s
- Dilution factor: 1/2 to 1/1000, customizable fractions
- Dilution accuracy: > 99% (in Standard or Accurate mode in optimal conditions)
- Max weight: 1000 g
- Max number of pumps: 2 integrated + 4 external

APPLICATIONS

The DiluFlow® Elite 1 kg gravimetric dilutor is used for the preparation of pharmaceutical and cosmetic samples for microbiological analysis. It is used for the preparation of 1 to 20 g sample diluted to 1/10th. With the DiluFlow® Elite 1 kg, the samples to be analyzed can be prepared in a tube or jar. Eg: active ingredients, cream, make-up...



Technical specifications of the range

SP: Single Pump
DP: Double Pump

	DiluFlow®		DiluFlow® Pro		DiluFlow® Elite 5 kg		DiluFlow® Elite 1 kg	
	SP	DP	SP	DP	SP	DP	SP	DP
OVERVIEW								
Reference	501 103	501 203	502 105	502 205	503 105	503 205	503 101	503 201
304L stainless steel body	✓		✓		✓		✓	
BagOpen® height < 30 cm	✓		✓		✓		✓	
Removable drip tray (Patented)	✓		✓		✓		✓	
BagOpen® with GeckoGrip system (patented)	✓		✓		✓		✓	
Magnetic stand for BagOpen® (Patented shape)	✓		✓		✓		✓	
LightCode: color status LED	✓		✓		✓		✓	
Compatible with Booster Kit	✓		✓		✓		✓	
Stainless casting electromechanical core	✓		✓		✓		✓	
Robotic arm	-		✓		✓		✓	
Compatible with Jumbo Kit	-		✓		✓		-	
Protection for dispensing nozzle	-		✓		✓		✓	
Up to 6 pumps	-		-		✓		✓	
Multi-dispensing mode (Patented)	-		-		✓		✓	
Powder mode	-		-		✓		✓	
Weighing mode	-		-		✓		✓	
Auto-tare function	-		-		✓		✓	
24 editable programs	-		-		✓		✓	
Bidirectional connectivity	-		-		✓		✓	
1 g dilution to 1/10th	-		-		-		✓	
SPECIFICATIONS								
Resolution up to 200 g	0.01 g							
Weighing range	0.1 to 3000 g		0.1 to 5000 g				0.1 to 1000 g	
Max. weight without support	4500 g		7000 g				1500 g	
Weighing accuracy	0 to 100 g: ± 0.05 g 100 to 3000 g: ± 0.1%		0 to 100 g: ± 0.05 g 100 to 5000 g: ± 0.1%				0 to 20 g: ± 0.01 g 20 to 1000 g: ± 0.1%	
Dilution factor	1/2 to 1/99				1/2 to 1/1000, customizable fractions			
Minimum weight required for dilution	5 g						0.5 g ⁽³⁾	
Minimum weight required for distribution	5 g							
Dilution/distribution accuracy	> 99% ⁽¹⁾							
Dilution time for a 25 g sample diluted to 1/10 th	< 9 s ⁽²⁾				< 8 s ⁽²⁾			

(1) in Standard or Accurate mode (in optimal conditions) (2) with Booster Kit in Fast mode (3) with a recommended dilution factor of 10



	DiluFlow®		DiluFlow® Pro		DiluFlow® Elite 5 kg		DiluFlow® Elite 1 kg	
	SP	DP	SP	DP	SP	DP	SP	DP
SPECIFICATIONS								
Dilution time for a 375 g sample diluted to 1/10th	-		< 80 s ⁽²⁾		< 75 s ⁽²⁾		-	
Distribution time for 90 mL	< 7 s ⁽²⁾				< 6 s ⁽²⁾			
Distribution time for 225 mL	< 10 s ⁽²⁾				< 9 s ⁽²⁾			
Max. number of pumps	2 integrated				2 integrated + 4 external			
Dilution/distribution mode	Fast - Standard - Accurate							
Language	English				English, French			
Voltage - Frequency	100-240 V~ 50-60 Hz							
Warranty	1 year							
Spare parts availability	10 years							
In compliance with	ISO 7218 - ISO 6887							
Manufactured under	CE, UKCA, RoHS, WEEE							
TRACEABILITY								
Traceability	Printer / Supervision software (export to Excel™ / OpenOffice™, CSV file, printer)				Printer / Export to Excel™ file / CSV file Export on USB key / LIMS			
Exported data	Sample weight / Total weight / Dilution factor / Dilution accuracy / Right or left pump + with supervision software: Sample number / Name of operator / Date / Time				Sample weight / Total weight / Dilution factor / Dilution accuracy / Diluent / Sample number / Diluent lot number / Date / Time / Last calibration date / Name of operator / Name of program			
Connection	RS232 output for printer / USB port for computer / Jack output for foot pedal connection				2 USB ports (type A) to connect a printer, keyboard, bar-code reader, USB key / 1 USB port (type B) to connect a computer / Jack socket to connect a foot pedal / Handy gun / Ethernet connection for LIMS			

DELIVERED WITH

DiluFlow®: 1 distribution arm, 1 drip tray 400, 1 or 2 pumps, 1 dispensing assembly (GL45 - Ø 6.4 mm) per pump, 1 USB cable, 1 supervision software, 1 power cord, 1 BagOpen® 400 for dilutors, 1 user manual, 1 set of 10 GeckoGrip, 1 set of adhesive gum, blender bags samples, 1 conformity certificate / warranty card.

DiluFlow® Pro: 1 drip tray 400, 1 or 2 pumps, 1 protection for dispensing nozzles, 1 dispensing assembly (GL45 - Ø 6.4 mm) per pump, 1 USB cable, 1 supervision software, 1 power cord, 1 BagOpen® 400 for dilutors, 1 user manual, 1 set of 10 GeckoGrip, 1 set of adhesive gum, 1 Allen wrench, blender bags samples, 1 conformity certificate / warranty card.

DiluFlow® Elite 5 kg: 1 drip tray 400, 1 or 2 pumps, 1 protection for dispensing nozzles, 1 dispensing assembly (GL45 - Ø 6.4 mm) per pump, 1 USB stick, 1 USB cable, 1 USB A Male / A Female extension cable, 1 power cord, 1 BagOpen® 400 for dilutors, 1 user manual, 1 set of 10 GeckoGrip, 1 pack of adhesive gum, 1 Allen wrench, blender bags samples, 1 conformity certificate / warranty card.

DiluFlow® Elite 1 kg: 1 drip tray 400, 1 or 2 pumps, 1 protection for dispensing nozzles, 1 dispensing assembly (GL45 - Ø 3.2 mm) per pump, 1 USB stick, 1 USB cable, 1 USB A Male / A Female extension cable, 1 power cord, 1 BagOpen® 400 for dilutors, 1 user manual, 1 set of 10 GeckoGrip, 1 set of adhesive gum, 1 Allen wrench, blender bags samples, 1 conformity certificate / warranty card.



WEIGHT AND DIMENSIONS

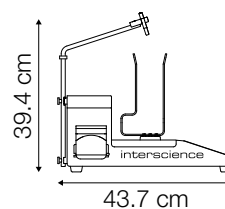
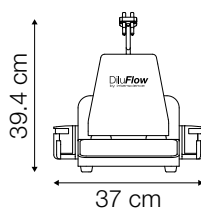
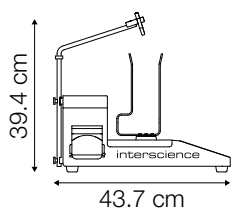
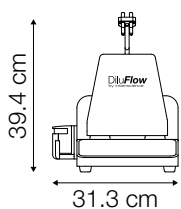

DiluFlow® (single pump) - Ref. 501 103	
Net weight	10.10 kg
Box dimensions (w x d x h)	55 x 55 x 40.5 cm
Gross weight	16.10 kg

DiluFlow® (double pump) - Ref. 501 203	
Net weight	12.50 kg
Box dimensions (w x d x h)	55 x 55 x 40.5 cm
Gross weight	18.60 kg

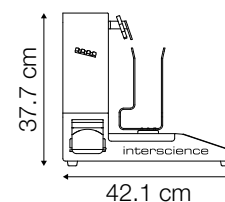
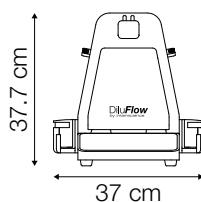
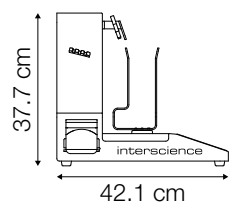
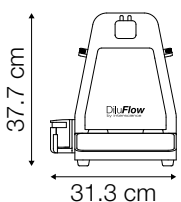

DiluFlow® Pro (single pump) - Ref. 502 105	
Net weight	12.30 kg
Box dimensions (w x d x h)	55 x 55 x 53 cm
Gross weight	18.10 kg

DiluFlow® Pro (double pump) - Ref. 502 205	
Net weight	14.80 kg
Box dimensions (w x d x h)	55 x 55 x 53 cm
Gross weight	21.20 kg

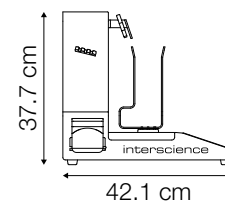
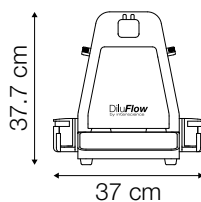
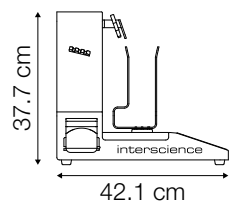
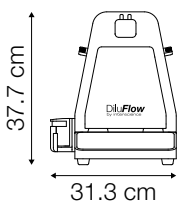

DiluFlow® Elite 5 kg (single pump) - Ref. 503 105	
Net weight	12.80 kg
Box dimensions (w x d x h)	55 x 55 x 53 cm
Gross weight	18.80 kg

DiluFlow® Elite 5 kg (double pump) - Ref. 503 205	
Net weight	15.30 kg
Box dimensions (w x d x h)	55 x 55 x 53 cm
Gross weight	21.40 kg

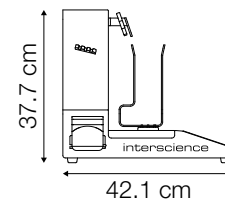
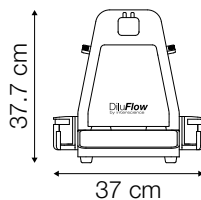
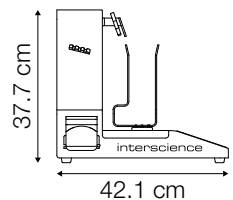
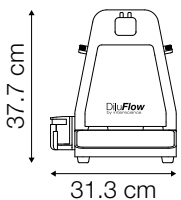

DiluFlow® Elite 1 kg (single pump) - Ref. 503 101	
Net weight	12.90 kg
Box dimensions (w x d x h)	55 x 55 x 53 cm
Gross weight	18.80 kg

DiluFlow® Elite 1 kg (double pump) - Ref. 503 201	
Net weight	15.20 kg
Box dimensions (w x d x h)	55 x 55 x 53 cm
Gross weight	21.90 kg

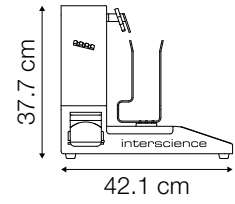
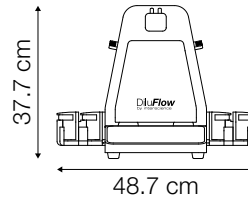
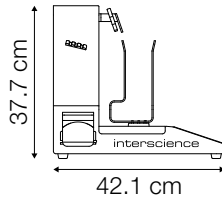
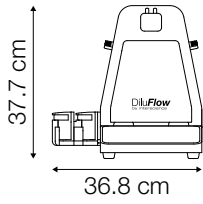

DiluFlow® Elite 5 kg (single pump) + Booster Kit Ref. 503 105 + Ref. 511 000	
Net weight	13.10 kg
Box dimensions (w x d x h)	55 x 55 x 53 cm
Gross weight	19.10 kg

DiluFlow® Elite 5 kg (double pump) + 2 Booster Kits Ref. 503 205 + Ref. 511 000	
Net weight	15.90 kg
Box dimensions (w x d x h)	55 x 55 x 53 cm
Gross weight	21.70 kg

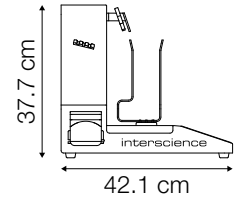
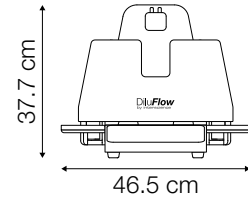
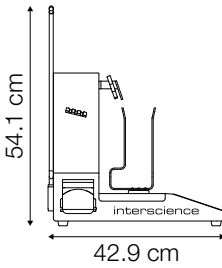
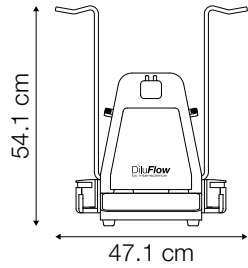

DiluFlow® Elite 5 kg (double pump) + 2 Integrable stand for broth bags - Ref. 503 205 + Ref. 505 010	
Net weight	16.40 kg
Box dimensions (w x d x h)	55 x 55 x 53 cm
Gross weight	23.40 kg

DiluFlow® Elite 5 kg (double pump) + Jumbo Kit Ref. 503 205 + Ref. 505 006		
Net weight	16 kg	
Box dimensions (w x d x h) (2 boxes)	DiluFlow Elite 5 kg: 55 x 55 x 53 cm	Jumbo Kit: 40 x 30 x 18 cm
Gross weight (2 boxes)	DiluFlow Elite 5 kg: 21.40 kg	Jumbo Kit: 0.70 kg

Product compatibility



Product	Model	DiluFlow®	DiluFlow® Pro	DiluFlow® Elite 5 kg	DiluFlow® Elite 1 kg
LAB BLENDERS					
MiniMix® 100 P CC	100	● ⁽²⁾	● ⁽²⁾	● ⁽²⁾	● ⁽²⁾
MiniMix® 100 W CC	100	● ⁽²⁾	● ⁽²⁾	● ⁽²⁾	● ⁽²⁾
BagMixer® 400 P	400	●	●	●	●
BagMixer® 400 W	400	●	●	●	●
BagMixer® 400 CC	400	●	●	●	●
BagMixer® S	400	●	●	●	●
BagMixer® SW	400	●	●	●	●
JumboMix® 3500 P CC	3500		● ⁽¹⁾	● ⁽¹⁾	
JumboMix® 3500 W CC	3500		● ⁽¹⁾	● ⁽¹⁾	
JumboMix® 3500 WarmMix® CC	3500		● ⁽¹⁾	● ⁽¹⁾	
LAB ACCESSORIES					
BagRack® Slide	400	●	●	●	●
BagRack®	100	● ⁽²⁾	● ⁽²⁾	● ⁽²⁾	● ⁽²⁾
	400	●	●	●	●
	3500		● ⁽¹⁾	● ⁽¹⁾	
BagClip®	100	● ⁽²⁾	● ⁽²⁾	● ⁽²⁾	● ⁽²⁾
	400	●	●	●	●
	3500		● ⁽¹⁾	● ⁽¹⁾	
BagOpen®	100	● ⁽²⁾	● ⁽²⁾	● ⁽²⁾	● ⁽²⁾
	400	●	●	●	●
	3500		●	●	
BagSeal®	-	●	●	●	●
BLENDER BAGS WITH FILTER					
BagFilter® Roll	400	●	●	●	●
BagFilter® Pipet	400	●	●	●	●
BagFilter® Pipet & Roll	400	●	●	●	●
BagFilter® P	400	●	●	●	●
	2000		● ⁽¹⁾	● ⁽¹⁾	
	3500		● ⁽¹⁾	● ⁽¹⁾	
BagFilter® S	400	●	●	●	●
BagFilter® Pull-Up	400	●	●	●	●
BagFilter® XF	400	●	●	●	●
BagPage® +	100	● ⁽²⁾	● ⁽²⁾	● ⁽²⁾	● ⁽²⁾
	400	●	●	●	●
	2000		● ⁽¹⁾	● ⁽¹⁾	
	3500		● ⁽¹⁾	● ⁽¹⁾	
BagPage® F	400	●	●	●	●
BagPage® R	400	●	●	●	●
BagPage® XR	400	●	●	●	●
BLENDER BAGS WITHOUT FILTER					
BagLight® PolySilk®	100	● ⁽²⁾	● ⁽²⁾	● ⁽²⁾	● ⁽²⁾
	400	●	●	●	●
	2000		● ⁽¹⁾	● ⁽¹⁾	
	3500		● ⁽¹⁾	● ⁽¹⁾	
BagLight® Multilayer®	400	●	●	●	●
BLENDER BAGS CULTURE MEDIA					
instaBAG® EPT	400	●	●	●	●
instaBAG® Fraser ½	400	●	●	●	●
instaBAG® MILK	225	●	●	●	●
	900		● ⁽¹⁾		● ⁽¹⁾
	2250		● ⁽¹⁾		● ⁽¹⁾
	3375		● ⁽¹⁾		● ⁽¹⁾







(1) with Jumbo kit option (ref. 505 006) (2) with BagOpen® 80/100 mL option (ref. 505 014)

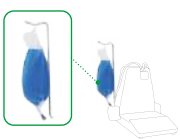

Accessories



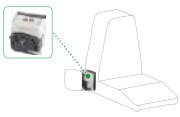

	Ref.	Designation	Description	Qty	Box		DiluFlow®	DiluFlow® Pro	DiluFlow® Elite 5 kg	DiluFlow® Elite 1 kg
					Dimensions (cm)	Gross weight (kg)				
	410 130	Film for printer	Thermal transfer film	1	12x10x8	0.08	•	•	•	•
	410 150	Printer	Thermal printer (RS 232 and USB output). Delivered with 1 thermal transfer film + power cable + USB cable	1	37x35x25	3.50	•	•	•	•
	413 002	2L bottle (GL45)	Set of 3 GL45 glass bottle (2L), autoclavable	3	37x37x37	4.10	•	•	•	•
	505 001	BagOpen® 400 for dilutors	Stand for 400 mL bags	1	22x25x12	0.50	•	•	•	•
	505 002	Weighing platform	To weigh and support a container. Not delivered with container	1	25x15x10	0.25	•	•	•	•
	505 003	Tongs platform	To hold a tube (Ø 10 to 60 mm). Not delivered with tube	1	25x15x10	1.00	•	•	•	•
	505 004	Adjustable distribution system	Ideal to fill various containers	1	35x30x20	0.60	•			
	505 005	Adjustable distribution system	Ideal to fill various containers. Delivered with a nozzle holder + screws + adjustable nozzle (Ø 3.2 mm - L: 23.5 cm) + adjustable nozzle (Ø 6.4 mm - L: 12 cm) + Allen key	1	25x15x10	0.25		•	•	•
	505 006	Jumbo kit	BagOpen® 3500 + 3500 mL DripTray + anti-splash extension for nozzle holder) + GeckoGrip	1	40x30x18	0.70		•	•	
	505 007	Pump module	External module with single pump + 513 043: Dispensing assembly (GL45 - Ø 6.4 mm)	1	23x31x27	5.00			•	•



Ref.	Designation	Description	Qty	Box	DiluFlow®	DiluFlow® Pro	DiluFlow® Elite 5 kg	DiluFlow® Elite 1 kg
				Dimensions (cm)				
				Gross weight (kg)				
	505 008	6 nozzles holder	1	12x10x8				
				0.09				
	505 009	GeckoGrip for BagOpen® 400/3500	10	12x10x8	•	•	•	•
				0.03				
	505 010	Integrable stand for broth bags	1	40x30x18	•	•	•	•
				0.70				
	505 014	BagOpen® 80/100 mL for dilutors	1	22x22x10	•	•	•	•
				0.50				
	505 015	GeckoGrip for BagOpen® 80/100	10	8x7	•	•	•	•
				0.02				
	505 016	BagOpen® 400 for dilutors (stainless steel)	1	24x20x12	•	•	•	•
				0.61				
	507 008	Foot pedal	1	15x10x10	•	•	•	•
				0.15				
	511 000	Booster kit	1	39x17x15	•	•	•	•
				0.38				
	513 001	5L bottle (GL45)	1	37x35x25	•	•	•	•
				1.70				
	513 005	Certified standard weight (500 g)	1	25x10x10	•	•	•	•
				0.80				
	513 015	Independent stand for broth bags	1	59x37x29	•	•	•	•
				1.90				



Gravimetric dilutors

	Ref.	Designation	Description	Qty	Box		DiluFlow®	DiluFlow® Pro	DiluFlow® Elite 5 kg	DiluFlow® Elite 1 kg
					Dimensions (cm)	Gross weight (kg)				
						513 053				
	521 012	Sticker for printer	Set of 2 rolls of 1000 stickers for thermal printer - Label size: 70 x 45 mm	2	20x10x10	1.00	•	•	•	•
	521 110	Paper for printer	Set of 2 thermal paper rolls for printer	2	25x10x10	1.50	•	•	•	•
	522 000	Bar-code reader	Bar-code reader (1D/2D)	1	26x16.5x11	0.60			•	•
	561 001	Handy Gun	Dispensing control with handy gun including electronic start button	1	15x15x5	0.12			•	•





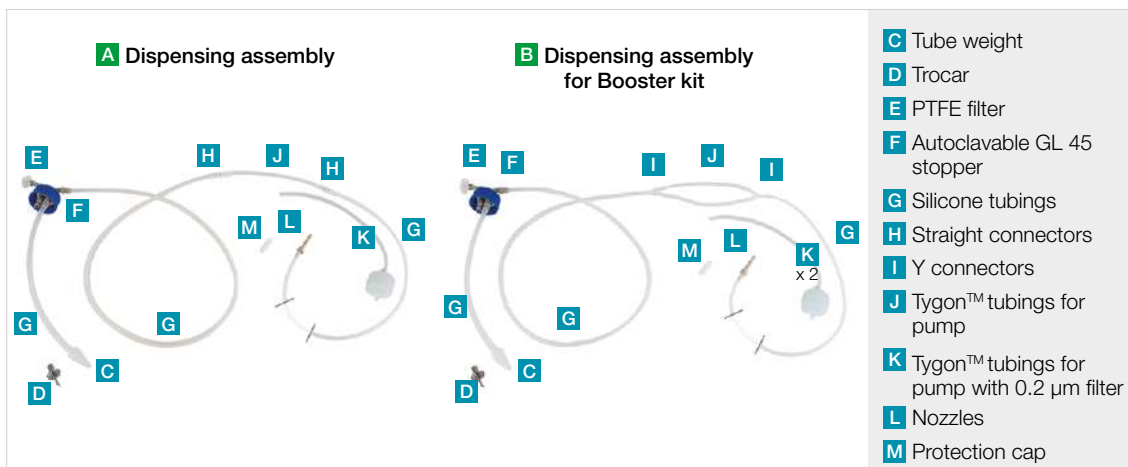







Tubings













Ref.	Designation	Description	Qty	Box			
				Dim. (cm)	Gross weight (kg)	DiluFlow®	DiluFlow® Pro
505 012	Adjustable nozzles (L 23.5 cm - tubings Ø 3.2 mm)	Set of 5 adjustable nozzles (Length: 23.5 cm - For inner Ø 3.2 mm tubings)	5	27x42	•	•	•
				0.35			
505 013	Adjustable nozzles (L 12 cm - tubings Ø 6.4 mm)	Set of 5 adjustable nozzles (Length: 12 cm - For inner Ø 6.4 mm tubings)	5	14x8	•	•	•
				0.15			
505 017	Nozzle cap for trocar	Set of 10 nozzles cap for trocar	10	8x12	•	•	•
				0.01			
513 008	Booster kit dispensing assembly (GL45 - Ø 3.2 mm)	Set of silicone tubings inner Ø 3.2 mm + GL45 screw cap + tube weight + nozzle + filter "Y"	1	39x27x15	•	•	•
				0.70			
513 009	Tubings + Y (Ø 3.2 mm)	Set of 5 dispensing tubings (silicone tubings + Tygon™ tubings + "Y" connectors) - inner Ø 3.2 mm	5	35x45	•	•	•
				0.47			
513 011	Tubings for pump (Ø 4.8 mm)	Set of 6 Tygon™ tubings for pump part (20 cm). inner Ø 4.8 mm	6	26x21x11	•	•	•
				0.06			



Gravimetric dilutors

	Ref.	Designation	Description	Qty	Box	DiluFlow®	DiluFlow® Pro	DiluFlow® Elite 5kg	DiluFlow® Elite 1kg
					Dim. (cm)				
					Gross weight (kg)				
	513 016	Dispensing assembly for broth bags (Ø 4.8 mm)	Distribution assembly Ø 4.8 mm for broth bags G + H + J + L + M	1	20x20 0.12	•	•	•	
	513 020	Trocar	Trocar for broth bags D	1	12x10x8 0.03	•	•	•	•
	513 023	PTFE filters 0.2 µm (Ø 25 mm)	Set of 5 autoclavable filters (0.2 µm) for GL45 bottle E	5	12x10x8 0.02	•	•	•	•
	513 024	Nozzles (tubings Ø 4.8 - 8 mm)	Set of 5 nozzles + caps for tubings from 4.8 to 8 mm inner diameter L + M	5	15x15x6 0.10	•	•	•	•
	513 039	Tube weights (Ø 6 mm)	Set of 5 tube weights - Ø 6 mm C	5	8x12 0.30	•	•	•	•
	513 040	Nozzles (tubings Ø 1.6 - 3.2 mm)	Set of 5 nozzles + caps for tubings from 1.6 to 3.2 mm inner diameter L + M	5	8x12 0.07	•	•	•	•
	513 041	Booster kit dispensing assembly (GL45 - Ø 6.4 mm)	Set of silicone tubings inner Ø 6.4 mm + GL45 screw cap + tube weight + nozzle + filter + "Y" B	1	23x35 0.24	•	•	•	•
	513 042	Tubings + Y (Ø 6.4 mm)	Set of 5 dispensing tubings (silicone tubings + Tygon™ tubings + "Y" connectors) - inner Ø 6.4 mm G + J + I	5	35x45 0.63	•	•	•	•
	513 043	Dispensing assembly (GL45 - Ø 6.4 mm)	Set of silicone tubings inner Ø 6.4 mm + GL45 screw cap + tube weight + nozzle + filter A	1	23x35 0.22	•	•	•	•
	513 044	Tubings (Ø 6.4 mm)	Set of 5 dispensing tubings (silicone tubings + Tygon™ tubings + straight connectors) - inner Ø 6.4 mm G + J + H	5	35x45 0.59	•	•	•	•



Ref.	Designation	Description	Qty	Box	DiluFlow®	DiluFlow® Pro	DiluFlow® Elite 5kg	DiluFlow® Elite 1kg	
				Dim. (cm)					
				Gross weight (kg)					
	513 045	Dispensing assembly (GL45 - Ø 3.2 mm)	Set of silicone tubings inner Ø 3.2 mm + GL45 screw cap + tube weight + nozzle + filter A	1	23x35	•	•	•	•
					0.20				
	513 047	Tubings (Ø 3.2 mm)	Set of 5 dispensing tubings (silicone tubings + Tygon™ tubings + straight connectors) - inner Ø 3.2 mm G + J + H	5	35x45	•	•	•	•
					0.45				
	513 048	Nozzle cap (Ø 1.6 - 3.2 mm)	Set of 10 protection cap for nozzles. For tubings from 1.6 to 3.2 mm inner diameter M	10	8x12	•	•	•	•
					0.01				
	513 050	Dispensing assembly with 0.2 µm filter (GL45 - Ø 6.4 mm)	Set of silicone tubings inner Ø 6.4 mm + GL45 screw cap + filter + tube weight + nozzle + 0.2 µm filter A	1	22x36x10	•	•	•	•
					0.25				
	513 051	Dispensing assembly + Y with 0.2 µm filter (GL45 - Ø 6.4 mm)	Set of silicone tubings inner Ø 6.4 mm + GL45 screw cap + filter + tube weight + nozzle + «Y» + 2 filters 0.2 µm B	1	22x36x10	•	•	•	•
					0.38				
	513 052	Tubings for pump with filter 0.2 µm (Ø 6.4 mm)	Set of 2 Tygon™ tubing for pump part (50 cm) + 2 filters 0.2 µm. inner Ø 6.4 mm K	2	22x36x10	•	•	•	•
					0.23				
	561 302	Tubings for pump (Ø 3.2 mm)	Set of 6 Tygon™ tubings for pump part (20 cm). Inner Ø 3.2 mm J	6	26x21.1x11	•	•	•	•
					0.04				
	561 304	Tubings for pump (Ø 6.4 mm)	Set of 6 Tygon™ tubings for pump part (20 cm). Inner Ø 6.4 mm J	6	26x21.1x11	•	•	•	•
					0.07				
	561 401	Autoclavable GL45 stopper + 0.2 µm filter	Autoclavable GL45 stopper + 0.2 µm filter F	1	10x12	•	•	•	•
					0.04				
	561 403	Straight connectors (tubings Ø 6.4 - 8 mm)	Set of 6 straight connectors for Ø 6.4 and 8 mm tubings H	6	12x8	•	•	•	•
					0.02				



Gravimetric dilutors

	Ref.	Designation	Description	Qty	Box		DiluFlow®	DiluFlow® Pro	DiluFlow® Elite 5kg	DiluFlow® Elite 1kg
					Dim. (cm)	Gross weight (kg)				
						561 404				
	562 401	Y connectors (tubings Ø 6.4 - 8 mm)	Set of 6 "Y" connectors for Ø 6.4 and 8 mm tubings	6	12x8	0.02	•	•	•	•
	562 402	Y connectors (tubings Ø 3.2 mm)	Set of 6 "Y" connectors for Ø 3.2 mm tubings	6	12x8	0.05	•	•	•	•



Lab blenders

Super efficient blending

BagMixer[®] laboratory blenders allow an optimal extraction of microorganisms in less than 60 seconds. With already more than 25 000 units sold worldwide, **BagMixer**[®] has become the name of a fast and safe sample preparation.



Top features of the range

25 years of innovation

With over 25,000 **BagMixer®** sold around the world, we are recognized today as the world specialist for sample preparation.

Super silent: less than 48 dB⁽¹⁾

Equipped with a soundproof outer shell and a double-glazed door for comfortable use in the laboratory.

Adjustable blending power

The adjustable pressure of the paddles allows the blending of the hardest and smallest samples.



PATENTED

BagMixer® S

BagMixer® SW

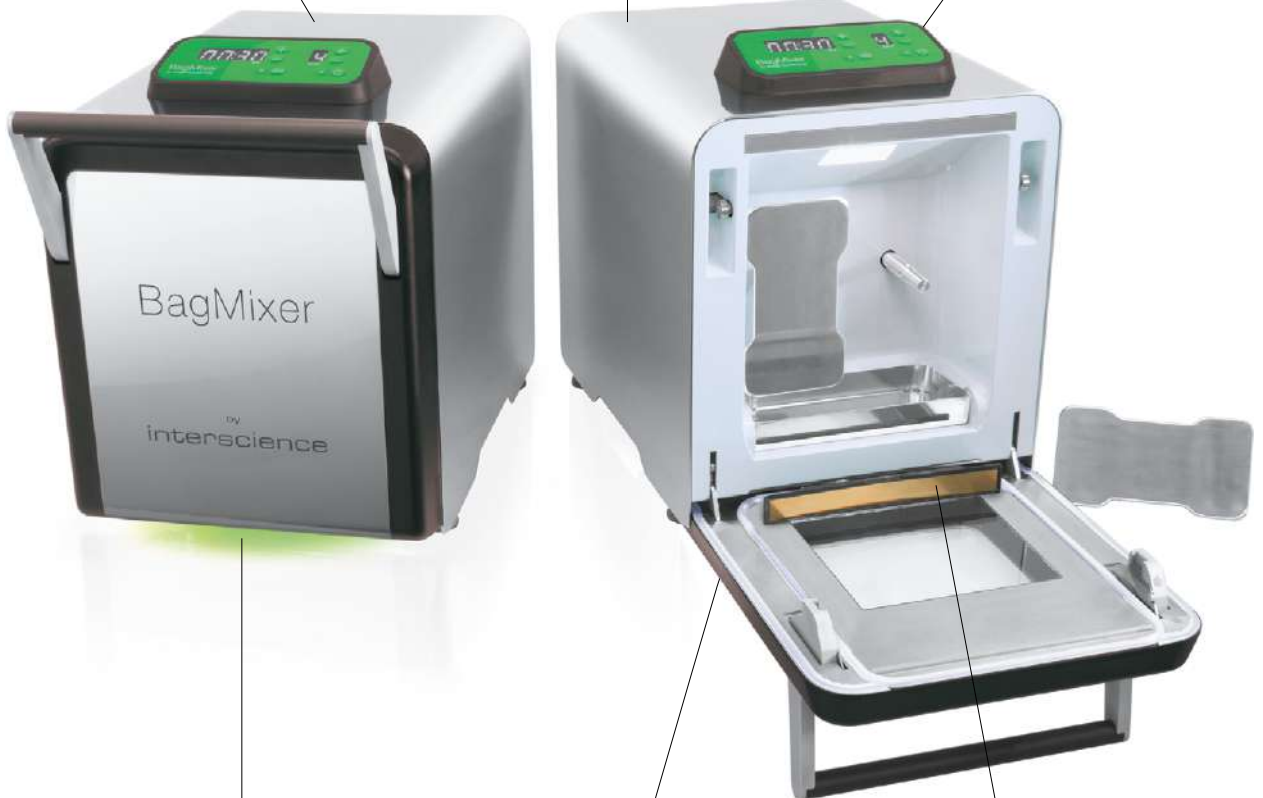

Lifetime warranty

Our mixers are guaranteed for 3 years⁽²⁾ and have a lifetime warranty on shock absorbers and window glass. Spare parts are available for 10 years.

TotalAccess system⁽¹⁾

Easy to clean: Flat door opening; removable blades and integrated autoclavable drip tray...

PATENTED

LightCode and LiquidSensor⁽¹⁾

LED lights indicate the blending status. The liquid detector warns you immediately if the bag leaks.

PATENTED

(1) Valid only on BagMixer® S or SW.

(2) After registration of the Warranty card.

100 mL range overview



MiniMix® 100 P CC	MiniMix® 100 W CC
100 mL lab blender	
Essential features	Window door

	Top features	
All stainless steel body	✓	✓
Multi-function digital screen	✓	✓
Variable speed	✓	✓
Adjustable blending power - PATENTED	✓	✓
Adjustable paddles Click & Clean® - PATENTED	✓	✓
Q-tight® closing	✓	✓
Window door lifetime warranty	-	✓



MiniMix® 100 P CC

100 mL lab blender

Essential features

Ref. 011 110 (100-127 V~ / 220-240 V~)

Ref. 011 230 (220-240 V~)



The **MiniMix® 100 P CC** is made for the blending of small samples. The patented adjustable blending power enables optimal microbial extraction, and can be adapted to the nature of the sample. The **MiniMix® 100 P CC** is equipped with patented **Click & Clean®** click-on paddles that allow full access to the blending chamber for cleaning.

MAIN FEATURES

- Optimal blending volume: 5 - 80 mL
- Variable speed: 3 - 6 - 9 - 12 strokes/second
- Variable blending time: 1 second - 1 hour or ∞
- **Click & Clean®** click-on paddles



Environmental



Pharmaceutical



Cosmetics



Veterinary

APPLICATIONS

MiniMix® 100 P CC is ideal for homogenization following small organ biopsy. It allows microbial extraction and filtration of the sample, guaranteeing its sterility. Its blending strength is adapted to any type of biological sample.



MiniMix® 100 W CC



100 mL lab blender

Window door

Ref. 013 110 (100-127 V~ / 220-240 V~)

Ref. 013 230 (220-240 V~)

Lab blenders

The **MiniMix® 100 W CC** is made for the blending of small samples. The patented adjustable blending power enables optimal microbial extraction, and can be adapted to the nature of the sample. The **MiniMix® 100 W CC** is equipped with patented **Click & Clean®** click-on paddles that allow full access to the blending chamber for cleaning. The window door permits a quick check-up at a glance.

MAIN FEATURES

- Optimal blending volume: 5 - 80 mL
- Variable speed: 3 - 6 - 9 - 12 strokes/second
- Variable blending time: 1 second - 1 hour or ∞
- Click & Clean® click-on paddles
- Window door

APPLICATIONS

MiniMix® 100 W CC is ideal for homogenizing small test samples of cosmetic products such as active ingredients. It allows microbial extraction and filtration of the sample, guaranteeing its sterility. The addition of sorbate during mixing solubilizes fat products and may create precipitates.



Environmental



Pharmaceutical



Cosmetics



Veterinary



400 mL range overview



BagMixer® 400 P	BagMixer® 400 W	BagMixer® 400 CC	BagMixer® 400 S	BagMixer® 400 SW
400 mL lab blender				
Essential features	Window door	Click & Clean®	Silent blending	Window door and LiquidSensor

	Top features				
All stainless steel body	✓	✓	✓	✓	✓
Window door	-	✓	✓	-	✓
Multi-function digital screen	-	-	✓	✓	✓
Adjustable blending power PATENTED	-	-	✓	✓	✓
Adjustable paddles Click & Clean® PATENTED	-	-	✓	✓	✓
Super silent	-	-	-	✓	✓
TotalAccess system PATENTED	-	-	-	✓	✓
LiquidSensor PATENTED	-	-	-	-	✓



BagMixer® 400 P

400 mL lab blender

Essential features

Ref. 021 000 (100-127 V~ / 220-240 V~)

Ref. 021 230 (220-240 V~)



The **BagMixer® 400 P** efficiently blends any type of sample, avoiding risk of cross-contamination. It is adapted to all types of applications and compatible with all blender bags. It is a sturdy tool, all stainless steel.

MAIN FEATURES

- Optimal blending volume: 50 - 400 mL
- Fixed speed: 8 strokes/second
- Variable blending time: 30 - 210 seconds or ∞
- 270° door opening
- **Q-Tight®** closing

APPLICATIONS

The **BagMixer® 400 P** paddle blender is used for microbiological analyses in the food, environmental, pharmaceutical, veterinary industries and in public research institutes. It is used for microbial extraction of samples for quality control of raw materials, in-process products and finished products.



Food



Environmental



Pharmaceutical



Veterinary



Public research



BagMixer® 400 W



400 mL lab blender

Window door

Ref. 022 000 (100-127 V~ / 220-240 V~)

Ref. 022 230 (220-240 V~)

The **BagMixer® 400 W** efficiently blends any type of sample, avoiding risk of cross-contamination. It is adapted to all types of applications and compatible with all blender bags. The window door enables a quick check-up of the blending, in process.

MAIN FEATURES

- Optimal blending volume: 50 - 400 mL
- Fixed speed: 8 strokes/second
- Variable blending time: 30 - 210 seconds or ∞
- Window door
- **Q-Tight®** closing



Food



Environmental



Pharmaceutical



Veterinary



Public research

APPLICATIONS

The **BagMixer® 400 W** paddle blender is used for microbiological analyses in the food, environmental, pharmaceutical, veterinary industries and in public research institutes. It is used for microbial extraction of samples for quality control of raw materials, in-process products and finished products.



BagMixer® 400 CC

400 mL lab blender

Click & Clean®

Ref. 024 230 (100-240 V~)



Lab blenders

The **BagMixer® 400 CC** efficiently blends any type of sample, avoiding risk of cross-contamination. It is adapted to all types of applications and compatible with all blender bags. The patented **Click & Clean®** click-on paddles enable access directly to the blending chamber for deep cleaning.



ORGANIZE YOUR WORKSTATION:

BagRack® (400 mL)

Ref. 221 040

[For more information, please refer to page 74](#)

MAIN FEATURES

- **Optimal blending volume: 50 - 400 mL**
- **Variable speed: 4, 6, 8, 10 strokes/second**
- **Variable blending time: 1 second - 1 hour or ∞/count-down**
- **Click & Clean® click-on paddles**
- **Q-Tight® closing**

APPLICATIONS

The **BagMixer® 400 CC** paddle blender is used for microbiological analyses in the food, environmental, pharmaceutical, veterinary industries and in public research institutes. It is used for microbial extraction of samples for quality control of raw materials, in-process products and finished products. Easy access for cleaning avoids the risk of contamination.



Food



Environmental



Pharmaceutical



Veterinary



Public research



BagMixer® 400 S



400 mL lab blender

Silent blending

Ref. 025 000 (100-240 V~)

The **BagMixer® 400 S** is a highly efficient lab blender: silent and ultra-robust. Adapted to all applications, it enables avoiding all risks of cross-contamination.

MAIN FEATURES

- Optimal blending volume: 50 - 400 mL
- Variable speed: 4, 6, 8, 10 strokes/second
- Variable blending time: 1 second - 1 hour or ∞/count-down
- **Click & Clean®** click-on paddles
- Silent blending: less than 48 dB



Food



Environmental



Pharmaceutical



Veterinary



Public research

APPLICATIONS

The **BagMixer® 400 S** paddle blender is used for microbiological analyses in the food, environmental, pharmaceutical, veterinary industries and in public research institutes. It is used for microbial extraction of samples for quality control of raw materials, in-process products and finished products. The leak detector warns of possible cross-contamination.



BagMixer® 400 SW



400 mL lab blender

Window door & LiquidSensor

Ref. 025 100 (100-240 V~)

Lab blenders

The **BagMixer® 400 SW** is a new generation lab blender. It is silent, very sturdy and user friendly. The window door enables a quick check-up of the blending, in process. It is adapted to all types of applications and compatible with all blender bags.

MAIN FEATURES

- **Optimal blending volume:** 50 - 400 mL
- **Variable speed:** 4, 6, 8, 10 strokes/second
- **Variable blending time:** 1 second - 1 hour or ∞/count-down
- **Click & Clean®** click-on paddles
- **Silent blending:** less than 48 dB

APPLICATIONS

The **BagMixer® 400 SW** paddle blender is used for microbiological analyses in the food, environmental, pharmaceutical, veterinary industries and in public research institutes. It is used for microbial extraction of samples for quality control of raw materials, in-process products and finished products. The leak detector warns of possible cross-contamination.



Food



Environmental



Pharmaceutical



Veterinary



Public research



3500 mL range overview



JumboMix® 3500 P CC	JumboMix® 3500 W CC	JumboMix® 3500 WarmMix® CC
3500 mL lab blender		
Essential features	Window door	Thermal regulation up to +50 °C

	Top features		
All stainless steel body	✓	✓	✓
Multi-function digital screen	✓	✓	✓
Adjustable blending power PATENTED	✓	✓	✓
Adjustable paddles Click & Clean® - PATENTED	✓	✓	✓
Window door lifetime warranty	-	✓	-
Regulated heated door	-	-	✓



JumboMix® 3500 P CC



3500 mL lab blender

Essential features

Ref. 031 110 (100-127 V~ / 220-240 V~)

Ref. 031 230 (220-240 V~)

JumboMix® 3500 P CC efficiently blends any type of sample, up to 375 g, for optimal microbial extraction. It is equipped with a patented system of adjustable paddles to adapt itself to any sample. It is also great for sample pooling. The multifunction screen enables easy control of the blending parameters.



OPTIMIZED ORGANIZATION AND HANDLING:

JumboStand

Ref. 037 000

[For more information, please refer to page 58](#)

MAIN FEATURES

- Optimal blending volume: 200 - 3750 mL
- Variable speed: 1.5 - 3 - 4.5 - 6 strokes/second
- Variable blending time: 1 second - 1 hour or ∞/count-down
- **Click & Clean®** click-on paddles

APPLICATIONS

JumboMix® 3500 P CC is suitable for blending plants for biochemical analysis or grapes for monitoring the winemaking process.



JumboMix® 3500 W CC



3500 mL lab blender

Window door

Ref. 032 110 (100-127 V~ / 220-240 V~)
Ref. 032 230 (220-240 V~)

The **JumboMix® 3500 W CC** efficiently blends any type of sample, up to 375 g, for optimal microbial extraction. It comes with a window door and a patented system of adjustable paddles to adapt itself to any sample. The **JumboMix® 3500 W CC** is ideal for sample pooling.



OPTIMIZED ORGANIZATION AND HANDLING:

JumboStand
Ref. 037 000

[For more information, please refer to page 58](#)

MAIN FEATURES

- Optimal blending volume: 200 - 3750 mL
- Variable speed: 1.5 - 3 - 4.5 - 6 strokes/second
- Variable blending time: 1 second - 1 hour or ∞/count-down
- **Click & Clean®** click-on paddles



Food



Public research

APPLICATIONS

JumboMix® 3500 W CC is great for sample pooling, in baby formula, chocolate, ground meat... It is used for the preparation of PCR testing of pathogens such as *E. coli* O157:H7, *Salmonella* spp., *Cryptosporidium* and *Giardia*... The **JumboMix® W CC** is especially designed for food analyses and public research.



JumboMix® 3500 WarmMix® CC



3500 mL lab blender

**Thermal regulation
up to +50 °C / +122 °F**

Ref. 033 110 (100-127 V~ / 220-240 V~)

Ref. 033 230 (220-240 V~)

Lab blenders

The **JumboMix® 3500 WarmMix® CC** efficiently blends any type of sample, up to 375 g, for optimal microbial extraction. Its regulated door (from 20 °C to 50 °C / from 68 °F to 122 °F) guarantees blendings that require regulated temperature, as for *Trichinella* testing in pork.



OPTIMIZED ORGANIZATION AND HANDLING:

JumboStand

Ref. 037 000

[For more information, please refer to page 58](#)

MAIN FEATURES

- Thermal regulation: up to +50 °C / +122 °F
- Optimal blending volume: 200 - 3750 mL
- Variable speed: 1.5 - 3 - 4.5 - 6 strokes/second
- Variable blending time: 1 second - 1 hour or ∞/count-down
- **Click & Clean®** click-on paddles

APPLICATIONS

JumboMix® 3500 WarmMix® CC is designed for the detection of *Trichinella* due to the temperature control of the door. It is used for the preparation of PCR pathogens such as *E. coli* O157:H7, *Salmonella* spp., *Cryptosporidium* and *Giardia*.



Food



Public research



Technical specifications of the range

	MiniMix® 100				BagMixer® 400			
	P CC		W CC		P		W	
OVERVIEW								
Reference	011 110	011 230	013 110	013 230	021 000	021 230	022 000	022 230
All stainless steel (304L)	✓		✓		✓		✓	
Stainless steel (304L) outer shell	-		-		-		-	
Adjustable blending power (Patented)	✓		✓		-		-	
Multi-function digital screen	✓		✓		-		-	
Adjustable paddles	✓		✓		-		-	
Side-by-side paddle stop	✓		✓		-		-	
Click & Clean® click-on paddles (Patented)	✓		✓		-		-	
Window door	-		✓		-		✓	
Super silent blending (less than 48 dB)	-		-		-		-	
LightCode system: color status LED	-		-		-		-	
Polycarbonate blending chamber with round corners: easy cleaning	-		-		-		-	
White LED light in blending chamber	-		-		-		-	
LiquidSensor: leakage detection	-		-		-		-	
SPECIFICATIONS								
Optimal blending volume	5 - 80 mL				50 - 400 mL			
Drip tray	Optional		Included		Optional		Included	
Q-Tight® closing	Special closing to prevent leakage from the top of the bag							
Brushless motor	-							
Variable blending time	1 s - 1 h or ∞				30 - 210 s or ∞			
Speed	Variable speed: 3 - 6 - 9 - 12 strokes/s				Fixed speed: 8 strokes/s			
Door	Plain door		Window door		Plain door		Window door	
Opening door	270° opening door							
Voltage - Frequencies	100-127 V~ / 220-240 V~ / 50-60 Hz	220-240 V~ / 50-60 Hz	100-127 V~ / 220-240 V~ / 50-60 Hz	220-240 V~ / 50-60 Hz	100-127 V~ / 220-240 V~ / 50-60 Hz	220-240 V~ / 50-60 Hz	100-127 V~ / 220-240 V~ / 50-60 Hz	220-240 V~ / 50-60 Hz
Lifetime warranty	Shock absorbers		Window door and Shock absorbers		Shock absorbers		Window door and Shock absorbers	
Warranty	3-year (after recording the warranty card)							
Spare parts availability	10 years							
In compliance with	ISO 7218, ISO 6887 and FDA BAM (Bacteriological Analytical Manual)							
Manufactured under	CE, UKCA, RoHS, WEEE							



BagMixer® 400			JumboMix® 3500					
CC	S	SW	P CC		W CC		WarmMix® CC	
OVERVIEW								
024 230	025 000	025 100	031 110	031 230	032 110	032 230	033 110	033 230
✓	-	-	✓	-	✓	-	-	✓
-	✓	✓	-	-	-	-	-	-
✓	✓	✓	✓	-	✓	-	-	✓
✓	✓	✓	✓	-	✓	-	-	✓
✓	✓	✓	✓	-	✓	-	-	✓
✓	✓	✓	✓	-	✓	-	-	✓
✓	✓	✓	✓	-	✓	-	-	✓
✓	-	✓	-	-	✓	-	-	-
-	✓	✓	-	-	-	-	-	-
-	✓	✓	-	-	-	-	-	-
-	✓	✓	-	-	-	-	-	-
-	✓	✓	-	-	-	-	-	-
-	-	✓	-	-	-	-	-	-
SPECIFICATIONS								
50 - 400 mL			200 - 3750 mL					
Included	Integrated		Optional		Included			
Special closing to prevent leakage from the top of the bag								
Silent blending	Super silent blending (less than 48 dB)		-					
1 s - 1 h or ∞/count-down								
Variable speed: 4 - 6 - 8 - 10 strokes/s			Variable speed: 1.5 - 3 - 4.5 - 6 strokes/s					
Window door	Plain door	Double layer window door	Plain door		Window door		Plain door, Regulated heating door	
270° opening door	TotalAccess system: total opening of the door for full access of the chamber (Patented)		270° opening door					
100-240 V~ 50-60 Hz			100-127 V~/220-240 V~ 50-60 Hz	220-240 V~ 50-60 Hz	100-127 V~/220-240 V~ 50-60 Hz	220-240 V~ 50-60 Hz	100-127 V~/220-240 V~ 50-60 Hz	220-240 V~ 50-60 Hz
Window door and Shock absorbers	Shock absorbers	Window and Shock absorbers	Shock absorbers		Window door and Shock absorbers		Shock absorbers	
3-year (after recording the warranty card)								
10 years								
ISO 7218, ISO 6887 and FDA BAM (Bacteriological Analytical Manual)								
CE, UKCA, RoHS, WEEE								



DELIVERED WITH

MiniMix® 100 P CC, BagMixer® 400 P, JumboMix® 3500 P CC: 1 power cable, 1 user manual, 1 quick user guide, 1 free pack of blender bags, 1 conformity certificate / warranty card.

MiniMix® 100 W CC, BagMixer® 400 W, BagMixer® 400 CC, JumboMix® 3500 W CC, JumboMix® 3500 WarmMix® CC: 1 drip tray, 1 power cable, 1 user manual, 1 quick user guide, 1 free pack of blender bags, 1 conformity certificate / warranty card.

BagMixer® 400 S, BagMixer® 400 SW: 1 integrated drip tray, 1 power cable, 1 user manual, 1 quick user guide, 1 free pack of blender bags, 1 conformity certificate / warranty card.

WEIGHT AND DIMENSIONS

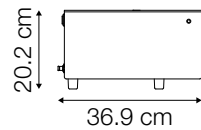
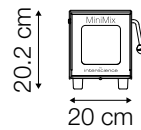
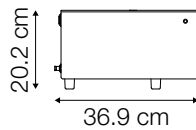
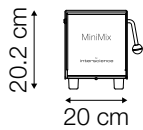

MiniMix® 100 P CC - Ref. 011 110 / Ref. 011 230	
Net weight	11.70 kg
Box (w x d x h)	49 x 29 x 33 cm
Gross weight	13.60 kg

MiniMix® 100 W CC - Ref. 013 110 / Ref. 013 230	
Net weight	11.70 kg
Box (w x d x h)	49 x 29 x 33 cm
Gross weight	13.70 kg

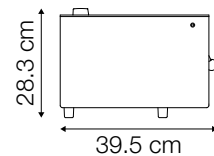
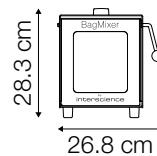
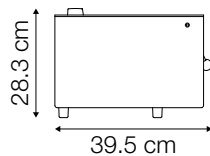
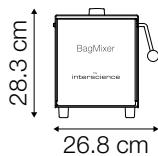

BagMixer® 400 P - Ref. 021 000 / Ref. 021 230	
Net weight	16.80 kg
Box (w x d x h)	49 x 34.5 x 37 cm
Gross weight	19.50 kg

BagMixer® 400 W - Ref. 022 000 / Ref. 022 230	
Net weight	16.60 kg
Box (w x d x h)	49 x 34.5 x 37 cm
Gross weight	19.70 kg

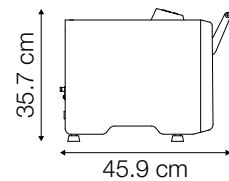
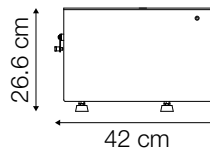
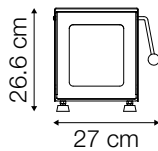

BagMixer® 400 CC - Ref. 024 230	
Net weight	16.10 kg
Box (w x d x h)	49 x 34.5 x 37 cm
Gross weight	19.20 kg

BagMixer® 400 S - Ref. 025 000	
Net weight	25.10 kg
Box (w x d x h)	56 x 41 x 50 cm
Gross weight	29.30 kg

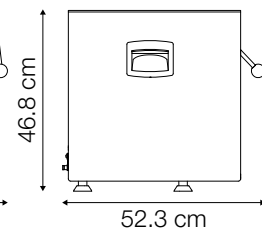
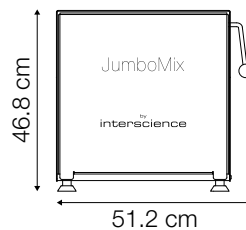
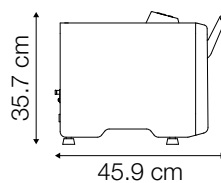

BagMixer® 400 SW - Ref. 025 100	
Net weight	24.70 kg
Box (w x d x h)	56 x 41 x 50 cm
Gross weight	28.90 kg

JumboMix® 3500 P CC - Ref. 031 110 / Ref. 031 230	
Net weight	55.80 kg
Box (w x d x h)	61 x 57 x 57 cm
Gross weight	60.50 kg

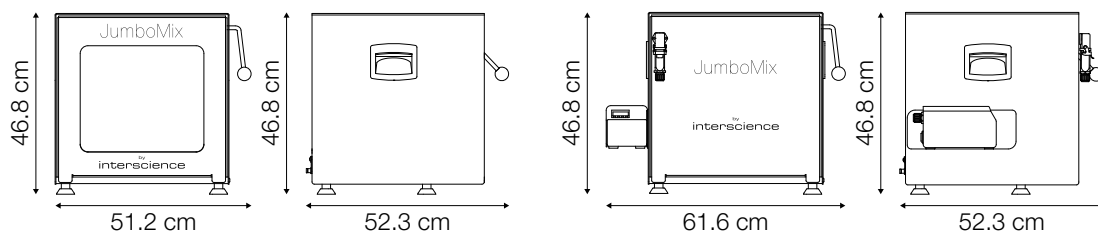

JumboMix® 3500 W CC - Ref. 032 110 / Ref. 032 230

Net weight	52.80 kg
Box (w x d x h)	61 x 57 x 57 cm
Gross weight	57.50 kg

JumboMix® 3500 WarmMix® CC - Ref. 033 110 / Ref. 033 230

Net weight	57.80 kg
Box (w x d x h)	61 x 57 x 57 cm
Gross weight	62.50 kg



Product compatibility

Product	Model	MiniMix® 100 P CC	MiniMix® 100 W CC	BagMixer® 400 P	BagMixer® 400 W
GRAVIMETRIC DILUTORS					
DiluFlow®	-	● ⁽²⁾	● ⁽²⁾	●	●
DiluFlow® Pro	-	● ⁽²⁾	● ⁽²⁾	●	●
DiluFlow® Elite 5 kg	-	● ⁽²⁾	● ⁽²⁾	●	●
DiluFlow® Elite 1 kg	-	● ⁽²⁾	● ⁽²⁾	●	●
LAB ACCESSORIES					
BagRack® Slide	400			●	●
BagRack®	100	●	●		
	400			●	●
	3500				
BagPipet®	-	●	●	●	●
BagClip®	100	●	●		
	400			●	●
	3500				
BagOpen®	100	●	●		
	400			●	●
	3500				
BagSeal®	-	●	●	●	●
BLENDER BAGS WITH FILTER					
BagFilter® Roll	400			●	●
BagFilter® Pipet	400			●	●
BagFilter® Pipet & Roll	400			●	●
BagFilter® P	400			●	●
	2000				
	3500				
BagFilter® S	400			●	●
BagFilter® Pull-Up	400			●	●
BagFilter® XF	400			●	●
BagPage® +	100	●	●		
	400			●	●
	2000				
	3500				
BagPage® F	400			●	●
BagPage® R	400			●	●
BagPage® XR	400			●	●
BLENDER BAGS WITHOUT FILTER					
BagLight® PolySilk®	100	●	●		
	400			●	●
	2000				
	3500				
BagLight® Multilayer®	400			●	●
BLENDER BAGS WITH CULTURE MEDIA					
instaBAG® BPW	400			●	●
instaBAG® Fraser ½	400			●	●
instaBAG® Milk	225			●	●
	900				
	2250				
	3375				
STERILE SAMPLING BAGS					
RollBag®	7.5 x 20	●	●		
	11 x 20	●	●		
	11 x 25	●	●		
	14 x 23	●	●		
	11 x 30	●	●		
	14 x 33	●	●	●	●
	17.5 x 30			●	●
	17.5 x 40			●	●
	25 x 38				
	25 x 50				
	38 x 56				

(1) with Jumbokit option (Ref. 505 006) (2) with BagOpen® 80/100 mL option (Ref. 505 014)



BagMixer® 400 CC	BagMixer® 400 S	BagMixer® 400 SW	JumboMixer® 3500 P CC	JumboMixer® 3500 W CC	JumboMixer® 3500 WarmMix CC
GRAVIMETRIC DILUTORS					
•	•	•			
•	•	•	• ⁽¹⁾	• ⁽¹⁾	• ⁽¹⁾
•	•	•	• ⁽¹⁾	• ⁽¹⁾	• ⁽¹⁾
•	•	•			
LAB ACCESSORIES					
•	•	•			
•	•	•			
•	•	•	•	•	•
•	•	•	•	•	•
•	•	•			
•	•	•	•	•	•
•	•	•			
BLENDER BAGS WITH FILTER					
•	•	•			
•	•	•			
•	•	•			
•	•	•			
•	•	•	•	•	•
•	•	•	•	•	•
•	•	•			
•	•	•			
•	•	•	•	•	•
•	•	•	•	•	•
•	•	•			
BLENDER BAGS WITHOUT FILTER					
•	•	•			
•	•	•	•	•	•
•	•	•	•	•	•
•	•	•			
BLENDER BAGS WITH CULTURE MEDIA					
•	•	•			
•	•	•			
•	•	•			
•	•	•	•	•	•
•	•	•	•	•	•
•	•	•			
STERILE SAMPLING BAGS					
•	•	•			
•	•	•			
•	•	•			
•	•	•	•	•	•
•	•	•	•	•	•
•	•	•	•	•	•



Accessories

	Ref.	Designation	Description	Qty	Box			
					Dimensions (cm)	MiniMix® 100	BagMixer® 400 P, W and CC	JumboMix® 3500
					Gross weight (kg)			
	016 000	Drip tray	Stainless steel security drip tray for MiniMix®	1	17.5x10x2	•		
					0.22			
	026 000	Drip tray	Stainless steel security drip tray for BagMixer® 400	1	23x12x2.3		•	
					0.33			
	036 000	Drip tray	Stainless steel security drip tray for JumboMix®	1	46x12.5x25			•
					0.67			
	037 000	JumboStand	Stainless steel ergonomic table for JumboMix® 3500. Dim. (w x d x h): 58 x 51 x 54 cm. Loading height of the JumboMix®: 45 cm	1	60x52x26			•
					16			



Dispensing pumps

Now dispensing is easy

FlexiPump® peristaltic dosing pumps allow the distribution of culture media, agar, diluents and all types of liquids. Their accuracy and speed guarantee an ultra-efficient preparation of your analyses.



Top features of the range

Designed for laboratories

Compact and easy to use with 3 dispensing modes, **FlexiPump®** has 32 customizable programs.

Control and accuracy of the distribution

Equipped with a powerful motor allowing the distribution of 50 µL to 99.9 L with a flow rate up to 2.5 L/min. The precision reaches 1%.

Ergonomics of the workstation

The large screen and the rotating button enable easy programming. The handy gun makes serial dispensing easy.



Culture media
E.g.: 9 mL in test tube



Agar
E.g.: 18 mL in Petri dish



Any liquid diluent
E.g.: 90 or 225 mL in bottle or blender bag

Simplified distribution

The distribution can be done in series. The control is increased with the handy gun, the adjustable arm and the foot pedal.

Range overview



FlexiPump®	FlexiPump® Pro
Dispensing pump for culture media preparation	
Fast and easy to use	High tech with traceability

	Top features	
Watson Marlow™ Pump	Single pump head	Double pump head
3 dispensing modes	✓	✓
Handy gun compatible	✓	✓
All stainless steel	✓	✓
Traceability	-	✓
Low-pulsation pump	-	✓
High accuracy, high flow pump	-	✓



FlexiPump®

Dispensing pump for culture media preparation

Fast and easy-to-use

Ref. 561 000



FlexiPump® is a peristaltic pump with enhanced accuracy for the dispensing of culture media, agar and any type of diluent. Compact and ergonomic, it comes with a user-friendly interface.



Food



Environmental



Pharmaceutical



Cosmetics



Veterinary



Public research



CONTROL AND ACCURACY: 80% OF CUSTOMERS USE IT

Handy Gun

Ref. 561 001

[For more information, please refer to page 67](#)

MAIN FEATURES

- **Dispensing mode:** Continuous - Dose - Multi-dose
- **Dose volume:** from 50 µL to 99.9 L
- **Flow rate:** up to 1.25 L/min.

APPLICATIONS

FlexiPump® is used for the preparation of peptone water tubes for serial dilutions. It allows the distribution of 18 mL of agar medium in Petri dishes. It is used in the food, environmental, pharmaceutical, cosmetic, veterinary industries and in public research institutes.



FlexiPump® Pro

Dispensing pump for culture media preparation

High-tech and traceability

Ref. 562 000



Dispensing pumps

FlexiPump® Pro is a peristaltic pump with enhanced accuracy for the dispensing of culture media, agar and any type of diluent. Compact and ergonomic, it comes with a user-friendly interface. Traceability is guaranteed by USB printer and connection.



WORKING HANDS-FREE

Adjustable dispensing arm

Ref. 561 002

[For more information, please refer to page 67](#)



Food



Environmental



Pharmaceutical



Cosmetics



Veterinary



Public research

MAIN FEATURES

- **Dispensing mode:** Continuous - Dose - Multi-dose
- **Dose volume:** from 50 µL to 99.9 L
- **Flow rate:** up to 2.5 L/min
- **Connection:** USB, RS232, Jack 3.5 mm

APPLICATIONS

FlexiPump® Pro is used for all mass dispensing in the food, environmental, pharmaceutical, cosmetic, veterinary industries and public research institutes. It can also be used for chemical transfer or bottling applications such as e-liquid packaging.

Technical specifications of the range



	FlexiPump®	FlexiPump® Pro
OVERVIEW		
Reference	561 000	562 000
All stainless steel (304L)	✓	✓
Handy gun compatible	✓	✓
Traceability	-	✓
Low-pulsation pump	-	✓
High accuracy, high flow pump	-	✓
SPECIFICATIONS		
Dose volume	50 µL to 99 L	
Dispensing modes	Continuous - Dose - Multi-dose	
Multi-dose pause	Adjustable from 0.1 to 99.9 s	
Watson Marlow™ pump	Single pump head	Low pulsation double pump head
Typical precision with inner diameter 3.2 mm tubing	9 mL: ± 1.8% - 18 mL: ± 1% 225 mL: ± 0.5%	9 mL: ± 0.9% - 18 mL: ± 0.5% 225 mL: ± 0.4%
Delivered with (tubing inner diameter)	3.2 mm dispensing assembly	Dispensing assemblies: 3.2 mm and 6.4 mm
Flow rates	1.5 mL/min to 1.25 L/min	3 mL/min to 2.5 L/min
Pump head rotating speed	10 to 550 rpm	
Tubing inner diameter (optional)	1.6 mm - 3.2 mm - 4.8 mm - 6.4 mm - 8 mm	
Tubing wall thickness	1.6 mm only	
Tubings made from	Tygon™ (for pump head) and silicon	
Voltage - Frequency	100-240 V ~ 50-60 Hz	
Warranty	1 year	
Spare parts availability	10 years	
In compliance with	ISO 7218 and FDA BAM (Bacteriological Analytical Manual)	
Manufactured under	CE, UKCA, RoHS, WEEE	
TRACEABILITY		
Traceability	-	USB, RS 232
Connections	-	USB, RS 232, Jack 3.5 mm
Data export	-	Excel™, Open Office Calc™, LIMS

DELIVERED WITH

FlexiPump®: 1 peristaltic Watson Marlow™ pump head, 1 set of 3.2 mm dispensing assembly (nozzle + GL45 bottle connector + filter + tubing + tube weight), 1 user manual, 1 power cord, 1 free pack of blender bags, 1 conformity certificate / warranty card.

FlexiPump® Pro: 2 peristaltic Watson Marlow™ pump heads, 1 set of 3.2 mm dispensing assembly (nozzle + GL45 bottle connector + filter + tubing + tube weight), 1 set of 6.4 mm dispensing assembly, 1 user manual, 1 power cord, 1 USB cable, 1 free pack of blender bags, 1 conformity certificate / warranty card.



WEIGHT AND DIMENSIONS

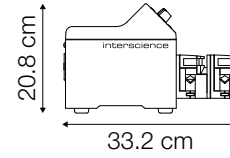
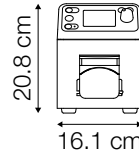
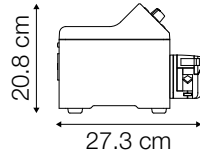
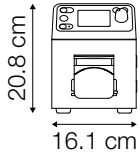

FlexiPump® - Ref. 561 000	
Net weight	5.40 kg
Box (w x d x h)	50 x 40 x 40 cm
Gross weight	8.20 kg

FlexiPump® Pro - Ref. 562 000	
Net weight	5.55 kg
Box (w x d x h)	50 x 40 x 40 cm
Gross weight	8.45 kg

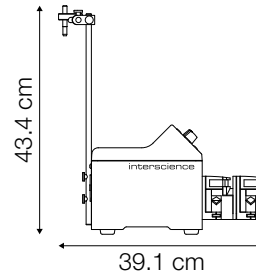
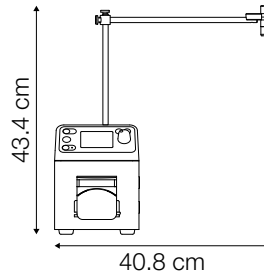
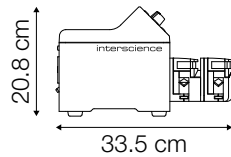
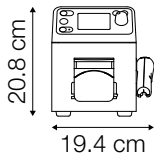

FlexiPump® Pro + Handy gun Ref. 562 000 + Ref. 561 001	
Net weight	5.70 kg
Box (w x d x h)	50 x 40 x 40 cm
Gross weight	8.60 kg

FlexiPump® Pro + Adjustable dispensing arm Ref. 562 000 + Ref. 561 002	
Net weight	6.10 kg
Box (w x d x h)	50 x 40 x 40 cm
Gross weight	9.10 kg













Product compatibility

Dispensing pumps

Product	Model	FlexiPump®	FlexiPump® Pro
LAB ACCESSORIES			
BagRack® Slide	400	•	•
BagRack®	100	•	•
	400	•	•
	3500	•	•
PetriPile®	55	•	•
	65	•	•
	90	•	•
	150	•	•
BagClip®	100	•	•
	400	•	•
	3500	•	•
BagOpen®	100	•	•
	400	•	•
	3500	•	•
BagSeal®	-	•	•
BLENDER BAGS WITH FILTER			
BagFilter® Roll	400	•	•
BagFilter® Pipet	400	•	•
BagFilter® Pipet & Roll	400	•	•
BagFilter® P	400	•	•
	2000	•	•
	3500	•	•
BagFilter® S	400	•	•
BagFilter® Pull-Up	400	•	•
BagFilter® XF	400	•	•
BagPage® +	100	•	•
	400	•	•
	2000	•	•
	3500	•	•
BagPage® F	400	•	•
BagPage® R	400	•	•
BagPage® XR	400	•	•
BLENDER BAGS WITHOUT FILTER			
BagLight® PolySilk®	100	•	•
	400	•	•
	2000	•	•
	3500	•	•
BagLight® Multilayer®	400	•	•
BLENDER BAGS WITH CULTURE MEDIA			
instaBAG® BPW	400	•	•
instaBAG® Fraser ½	400	•	•
instaBAG® Milk	225	•	•
	900	•	•
	2250	•	•
	3375	•	•
STERILE SAMPLING BAGS			
RollBag®	7.5 x 20	•	•
	11 x 20	•	•
	11 x 25	•	•
	14 x 23	•	•
	11 x 30	•	•
	14 x 33	•	•
	17.5 x 30	•	•
	17.5 x 40	•	•
	25 x 38	•	•
	25 x 50	•	•
38 x 56	•	•	







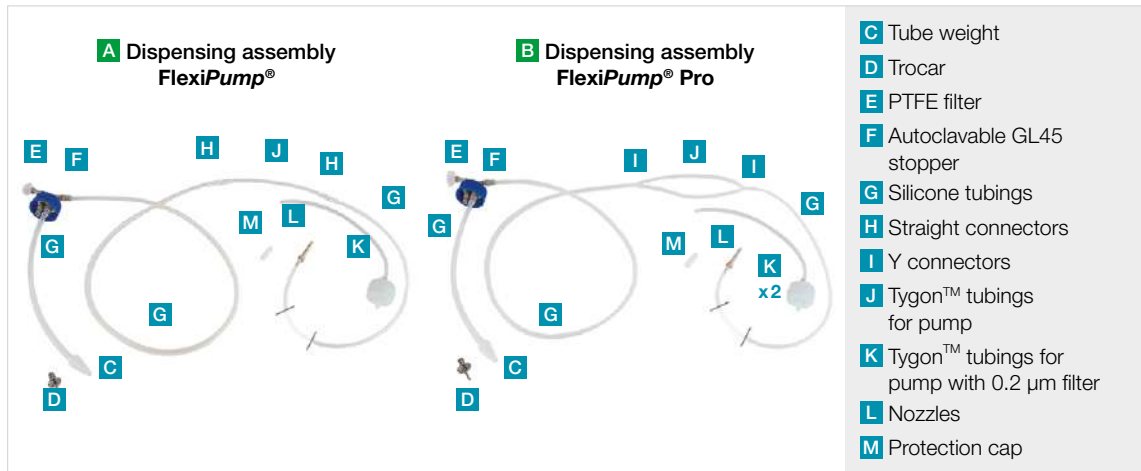

Accessories

	Ref.	Designation	Description	Qty	Box		FlexiPump®	FlexiPump® Pro
					Dimensions (cm)	Gross weight (kg)		
	410 130	Film for printer	Thermal transfer film	1	12x10x8	0.08		•
	410 150	Printer	Thermal printer (RS 232 and USB output). Delivered with 1 thermal transfer film + power cable + USB cable	1	37x35x25	3.50		•
	413 002	2L bottle (GL45)	Set of 3 GL45 glass bottles (2L), autoclavable	3	37x37x37	4.10	•	•
	507 008	Foot pedal	For hands-free dispensing. Connection with a 3.5 mm Jack	1	15x10x10	0.15	•	•
	513 001	5L bottle (GL45)	GL45 glass bottle (5L), autoclavable	1	37x35x25	1.70	•	•
	513 015	Independent stand for broth bags	Independent stand for 2 broth bags	1	59x37x29	1.90	•	•
	521 012	Sticker for printer	Set of 2 rolls of 1000 stickers for thermal printer - Label size: 70 x 45 mm	2 x 1000	20x10x10	1		•
	521 110	Paper for printer	Set of 2 thermal paper rolls for printer	2	25x10x10	1.50		•
	561 001	Handy Gun	Dispensing control with handy gun including electronic start button	1	15x15x5	0.12	•	•
	561 002	Adjustable dispensing arm	For use with other containers	1	34x22x12	0.60	•	•













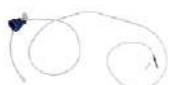

Tubings

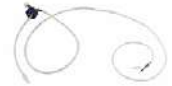













	Ref.	Designation	Description	Qty	Box		FlexiPump®	FlexiPump® Pro
					Dimensions (cm)	Gross weight (kg)		
	413 028	Tube weights (Ø 3 mm)	Set of 5 tube weights (inner Ø 3 mm)	5	12x8	0.04	•	•
	505 017	Nozzle cap for trocar	Set of 10 nozzles cap for trocar	10	8x12	0.01	•	•
	513 011	Tubings for pump (Ø 4.8 mm)	Set of 6 Tygon™ tubings for pump part (20 cm), inner Ø 4.8 mm	6	26x21x11	0.06	•	•
	513 020	Trocar	Trocar for broth bags	1	12x10x8	0.03	•	•
	513 023	PTFE filters 0.2 µm (Ø 25 mm)	Set of 5 autoclavable filters (0.2 µm) for GL45 bottle	5	12x10x8	0.02	•	•
	513 024	Nozzles (tubings Ø 4.8 - 8 mm)	Set of 5 nozzles + caps for tubings from 4.8 to 8 mm inner diameter	5	15x15x6	0.10	•	•
	513 039	Tube weights (Ø 6 mm)	Set of 5 tube weights - Ø 6 mm	5	8x12	0.30	•	•



	Ref.	Designation	Description	Qty	Box		FlexiPump®	FlexiPump® Pro
					Dimensions (cm)	Gross weight (kg)		
	513 040	Nozzles (tubings Ø 1.6 - 3.2 mm)	Set of 5 nozzles + caps for tubings from 1.6 to 3.2 mm inner diameter L + M	5	8x12	0.07	•	•
	513 048	Nozzle cap (Ø 1.6 - 3.2 mm)	Set of 10 protection caps for nozzles. For tubings from 1.6 to 3.2 mm inner diameter M	10	8x12	0.01	•	•
	513 052	Tubings for pump with filter 0.2 µm (Ø 6.4 mm)	Set of 2 Tygon™ tubing for pump part (50 cm) + 2 filters 0.2 µm inner Ø 6.4 mm K	2	22x36x10	0.23	•	•
	561 050	Dispensing assembly with 0.2 µm filter (GL45 - Ø 6.4 mm)	Set of silicone tubings inner Ø 6.4 mm + GL45 screw cap + filter + tube weight + nozzle + 0.2 µm filter for FlexiPump® A	1	22x36x10	0.27	•	
	561 101	Dispensing assembly (GL45 - Ø 1.6 mm)	Set of silicone tubings inner Ø 1.6 mm + GL45 screw cap + tube weight + nozzle + filter A	1	39x27x15	0.15	•	
	561 102	Dispensing assembly (GL45 - Ø 3.2 mm)	Set of silicone tubings inner Ø 3.2 mm + GL45 screw cap + tube weight + nozzle + filter A	1	39x27x15	0.20	•	
	561 103	Dispensing assembly (GL45 - Ø 4.8 mm)	Set of silicone tubings inner Ø 4.8 mm + GL45 screw cap + tube weight + nozzle + filter A	1	39x27x15	0.25	•	
	561 104	Dispensing assembly (GL45 - Ø 6.4 mm)	Set of silicone tubings inner Ø 6.4 mm + GL45 screw cap + tube weight + nozzle + filter A	1	39x27x15	0.25	•	
	561 105	Dispensing assembly (GL45 - Ø 8 mm)	Set of silicone tubings inner Ø 8 mm + GL45 screw cap + tube weight + nozzle + filter A	1	39x27x15	0.25	•	
	561 201	Tubings (Ø 1.6 mm)	Set of 5 dispensing tubings (silicone tubings + Tygon™ tubings + straight connectors) - inner Ø 1.6 mm G + J + H	5	39x27x15	0.35	•	
	561 202	Tubings (Ø 3.2 mm)	Set of 5 dispensing tubings (silicone tubings + Tygon™ tubings + straight connectors) - inner Ø 3.2 mm G + J + H	5	39x27x15	0.46	•	
	561 203	Tubings (Ø 4.8 mm)	Set of 5 dispensing tubings (silicone tubings + Tygon™ tubings + straight connectors) - inner Ø 4.8 mm G + J + H	5	39x27x15	0.60	•	



Dispensing pumps

	Ref.	Designation	Description	Qty	Box		FlexiPump®	FlexiPump® Pro
					Dimensions (cm)	Gross weight (kg)		
	561 204	Tubings (Ø 6.4 mm)	Set of 5 dispensing tubings (silicone tubings + Tygon™ tubings + straight connectors) - inner Ø 6.4 mm G + J + H	5	39x27x15	0.60	•	
	561 205	Tubings (Ø 8 mm)	Set of 5 dispensing tubings (silicone tubings + Tygon™ tubings + straight connectors) - inner Ø 8 mm G + J + H	5	39x27x15	0.60	•	
	561 301	Tubings for pump (Ø 1.6 mm)	Set of 6 Tygon™ tubings for pump part (20 cm). Inner Ø 1.6 mm J	6	26x21.1x11	0.03	•	•
	561 302	Tubings for pump (Ø 3.2 mm)	Set of 6 Tygon™ tubings for pump part (20 cm). Inner Ø 3.2 mm J	6	26x21.1x11	0.04	•	•
	561 304	Tubings for pump (Ø 6.4 mm)	Set of 6 Tygon™ tubings for pump part (20 cm). Inner Ø 6.4 mm J	6	26x21.1x11	0.07	•	•
	561 305	Tubings for pump (Ø 8 mm)	Set of 6 Tygon™ tubings for pump part (20 cm). Inner Ø 8 mm J	6	26x21.1x11	0.08	•	•
	561 401	Autoclavable GL45 stopper + 0.2 µm filter	Autoclavable GL45 stopper + 0.2 µm filter F	1	10x12	0.04	•	•
	561 402	Straight connectors (tubings Ø 1.6 mm)	Set of 6 straight connectors for inner Ø 1.6 mm tubings H	6	12x8	0.01	•	
	561 403	Straight connectors (tubings Ø 6.4 - 8 mm)	Set of 6 straight connectors for inner Ø 6.4 and 8 mm tubings H	6	12x8	0.02	•	
	561 404	Straight connectors (tubings Ø 3.2 - 4.8 mm)	Set of 6 straight connectors for inner Ø 4.8 and 3.2 mm tubings H	6	12x8	0.01	•	
	562 051	Dispensing assembly + Y with 0.2 µm filter (GL45 - Ø 6.4 mm)	Set of silicone tubings inner Ø 6.4 mm + GL45 screw cap + filter + tube weight + nozzle + "Y" + 2 filters 0.2 µm for FlexiPump® Pro B	1	22x36x10	0.40		•
	562 101	Dispensing assembly + Y (GL45 - Ø 1.6 mm)	Set of silicone tubings inner Ø 1.6 mm + GL45 screw cap + tube weight + nozzle + filter + "Y" B	1	39x27x15	0.13		•



Dispensing pumps

	Ref.	Designation	Description	Qty	Box		FlexiPump®	FlexiPump® Pro
					Dimensions (cm)	Gross weight (kg)		
	562 102	Dispensing assembly + Y (GL45 - Ø 3.2 mm)	Set of silicone tubings inner Ø 3.2 mm + GL45 screw cap + tube weight + nozzle + filter + "Y" B	1	20x20x10	0.20		•
	562 103	Dispensing assembly + Y (GL45 - Ø 4.8 mm)	Set of silicone tubings inner Ø 4.8 mm + GL45 screw cap + tube weight + nozzle + filter + "Y" B	1	35x21x10	0.25		•
	562 104	Dispensing assembly + Y (GL45 - Ø 6.4 mm)	Set of silicone tubings inner Ø 6.4 mm + GL45 screw cap + tube weight + nozzle + filter + "Y" B	1	25x20x10	0.25		•
	562 105	Dispensing assembly + Y (GL45 - Ø 8 mm)	Set of silicone tubings inner Ø 8 mm + GL45 screw cap + tube weight + nozzle + filter + "Y" B	1	35x21x10	0.25		•
	562 201	Tubings + Y (Ø 1.6 mm)	Set of 5 dispensing tubings (silicone tubings + Tygon™ tubings + "Y" connectors) - inner Ø 1.6 mm G + J + I	5	25x25x10	0.40		•
	562 202	Tubings + Y (Ø 3.2 mm)	Set of 5 dispensing tubings (silicone tubings + Tygon™ tubings + "Y" connectors) - inner Ø 3.2 mm G + J + I	5	30x20x10	0.50		•
	562 203	Tubings + Y (Ø 4.8 mm)	Set of 5 dispensing tubings (silicone tubings + Tygon™ tubings + "Y" connectors) - inner Ø 4.8 mm G + J + I	5	30x20x10	0.65		•
	562 204	Tubings + Y (Ø 6.4 mm)	Set of 5 dispensing tubings (silicone tubings + Tygon™ tubings + "Y" connectors) - inner Ø 6.4 mm G + J + I	5	30x20x20	0.65		•
	562 205	Tubings + Y (Ø 8 mm)	Set of 5 dispensing tubings (silicone tubings + Tygon™ tubings + "Y" connectors) - inner Ø 8 mm G + J + I	5	30x20x20	0.70		•
	562 400	Y connectors (tubings Ø 1.6 mm)	Set of 6 "Y" connectors for Ø 1.6 mm tubings I	6	12x8	0.02		•
	562 401	Y connectors (tubings Ø 6.4 - 8 mm)	Set of 6 "Y" connectors for Ø 6.4 and 8 mm tubings I	6	12x8	0.02		•
	562 402	Y connectors (tubings Ø 3.2 mm)	Set of 6 "Y" connectors for Ø 3.2 mm tubings I	6	12x8	0.05		•



Lab accessories

Complete range of laboratory accessories

BagTools® accessories range ensures quality laboratory work in optimal conditions of safety and comfort.

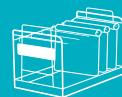

BagRack® Slide

Storage rack for bags



Ideal for pathogen research

Ref. 221 440 (400 mL)
Drip tray - Ref. 221 042

Lab accessories

The **BagRack® Slide** enables the organized, hygienic and fast storage of bags by sliding them to the side. It is ideal for sequential pipetting in addition to **BagFilter® Pipet & Roll** bags. **BagRack® Slide** is specifically suited for pathogen research.

MAIN FEATURES

- Available for 400 mL (12 bags capacity)
- Autoclavable and stackable
- All stainless steel

APPLICATIONS

BagRack® Slide is used for microbiological analysis in the food and environmental industries and public research institutes. It is particularly suited for the search of *Listeria* and *Salmonella*-type pathogens, as well as for quality indicators involving successive pipettings.

WEIGHT AND DIMENSIONS

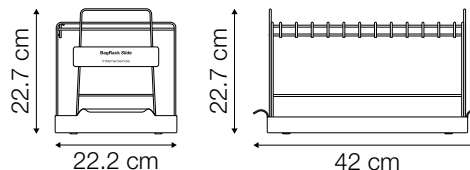
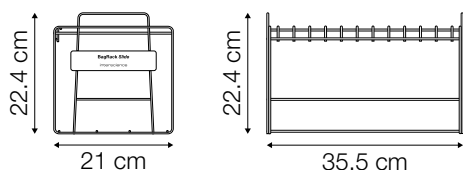

BagRack® Slide - Ref. 221 440	
Net weight	1.06 kg
Box (w x d x h)	37 x 23 x 24 cm
Gross weight	1.60 kg

BagRack® Slide + Drip Tray - Ref. 221 440 + Ref. 221 042		
Net weight	2.01 kg	
Box (w x d x h)	BagRack® Slide 37 x 23 x 24 cm	Drip Tray 43 x 24 x 5.5 cm
Gross weight	2.80 kg	



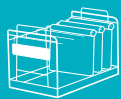

BagRack®

Storage rack for bags

Clean and organized storage

Ref. 221 040 (400 mL)



Ref. 221 010
(80/100 mL)



Ref. 221 350
(2000/3500 mL - 4 comp.)



Ref. 221 352
(2000/3500 mL - 2 comp.)

BagRack® allows the clean and orderly storage of bags during sample preparation.



Food



Environmental



Pharmaceutical



Public research

MAIN FEATURES

- Available for bag sizes:
80 mL / 100 mL - capacity: 11 bags
400 mL - capacity: 10 bags
2000 mL / 3500 mL (4 compartments) - capacity: 4 bags
2000 mL / 3500 mL (2 compartments) - capacity: 2 bags
- Autoclavable and stackable
- All stainless steel

APPLICATIONS

BagRack® is used for microbiological analysis in the food, environmental and pharmaceutical industries and in public research institutes. It allows the storage of samples in their preparation bag during the analysis of quality indicators.

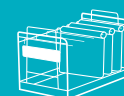

WEIGHT AND DIMENSIONS

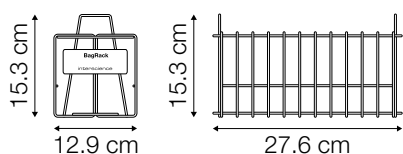

BagRack® 80/100 - Ref. 221 010	
Net weight	0.67 kg
Box (w x d x h)	28.5 x 14 x 16.5 cm
Gross weight	0.70 kg

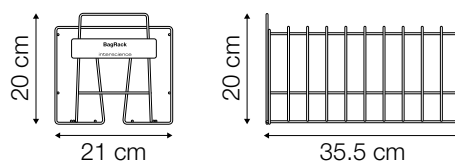

BagRack® 400 - Ref. 221 040	
Net weight	1.01 kg
Box (w x d x h)	37 x 22 x 21 cm
Gross weight	1.37 kg

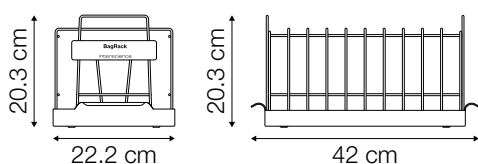

BagRack® 400 + Drip Tray - Ref. 221 040 + Ref. 221 042		
Net weight	1.96 kg	
Box (w x d x h) (2 boxes)	BagRack® 400 37 x 22 x 21 cm	Drip Tray 43 x 24 x 5.5 cm
Gross weight	2.57 kg	

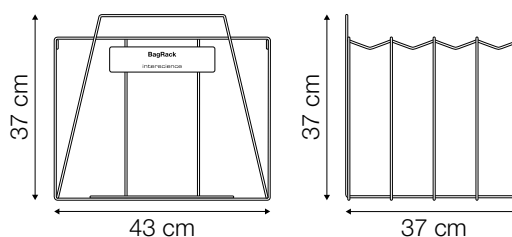

BagRack® 3500 (4 compartments) - Ref. 221 350	
Net weight	2.53 kg
Box (w x d x h)	45 x 39 x 39 cm
Gross weight	3.44 kg

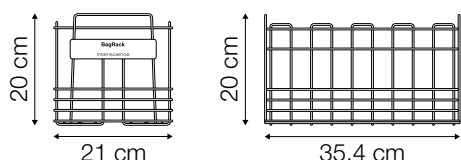

BagRack® 3500 (2 compartments) - Ref. 221 352	
Net weight	1.11 kg
Box (w x d x h)	37 x 23 x 22 cm
Gross weight	1.54 kg

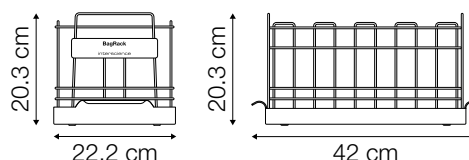

BagRack® 3500 (2 compartments) + Drip Tray Ref. 221 352 + Ref. 221 042		
Net weight	2.06 kg	
Box (w x d x h) (2 boxes)	BagRack® 3500 37 x 23 x 22 cm	Drip Tray 43 x 24 x 5.5 cm
Gross weight	2.74 kg	

ACCESSORIES

	Ref.	Designation	Description	Qty	Box
					Dimensions (cm)
					Gross weight (kg)
	221 042	Drip tray	Stainless steel security drip tray for BagRack® 400, BagRack® Slide and BagRack® 3500 (2 compartments)	1	43x24x5.5
					1.20

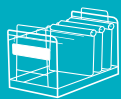

PetriPile®

Petri dish storage stack



Ideal for transport and storage

Ref. 241 090 (Ø 90 mm)



Ref. 241 055
(Ø 55 mm)



Ref. 241 065
(Ø 65 mm)



Ref. 241 150
(Ø 150 mm)

PetriPile® ensures safe handling, carrying and storage of Petri dishes. Its ergonomics make the loading of your incubator easier and gives overall visibility of your Petri dishes.



Food



Environmental



Pharmaceutical



Public research

MAIN FEATURES

- For Petri dishes:
 - Ø 55 mm - capacity: 36 Petri dishes
 - Ø 65 mm - capacity: 36 Petri dishes
 - Ø 90 mm - capacity: 36 Petri dishes
 - Ø 150 mm - capacity: 16 Petri dishes
- Autoclavable and stackable
- All stainless steel

APPLICATIONS

PetriPile® is used for microbiological analyses in the food, environmental and pharmaceutical industries and public research institutes. **PetriPile®** is in compliance with ISO 7218 standard and the use according to Good Laboratory Practice (GLP).

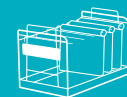

WEIGHT AND DIMENSIONS

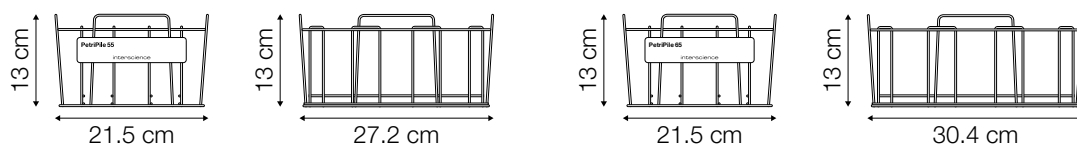

PetriPile® 55 - Ref. 241 055

Net weight	0.79 kg
Box (w x d x h)	28.5 x 23 x 15 cm
Gross weight	1.12 kg

PetriPile® 65 - Ref. 241 065

Net weight	0.77 kg
Box (w x d x h)	31.5 x 23.5 x 14.5 cm
Gross weight	0.98 kg

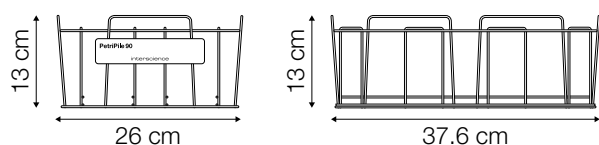

PetriPile® 90 - Ref. 241 090

Net weight	1.03 kg
Box (w x d x h)	38 x 27.5 x 15 cm
Gross weight	1.40 kg

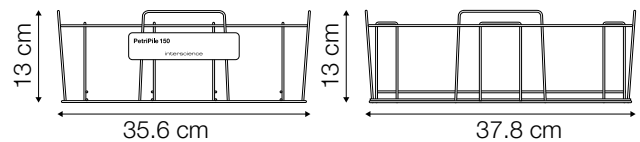

PetriPile® 150 - Ref. 241 150

Net weight	0,88 kg
Box (w x d x h)	39 x 37 x 14.5 cm
Gross weight	1.26 kg



BagPipet®

Fixed-volume pipet

Simplicity and flexibility

Ref. 251 091

BagPipet® is an autoclavable pipet that measures a fixed volume of any liquid. It is used with a **BagTips®** straw tip, the length of which makes it possible to reach the bottom of any test bag and avoid cross-contamination.

MAIN FEATURES

- Fixed-volume pipet
- 3 calibrations: 0.1 mL / 0.9 mL / 1 mL
- Calibrated to be used according to G.L.P (Good Laboratory Practices)



Food



Environmental



Public research

APPLICATIONS

BagPipet® is used for microbiological analysis in the food and environmental industries and in public research institutes. It prevents cross-contamination during pipetting in a sample pooling preparation for pathogen research and especially during subculture.

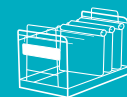

TECHNICAL SPECIFICATIONS

SPECIFICATIONS	
Autoclavable	✓
Ejection of disposable straw	✓
Easy calibration	✓
Calibration settings	0.1 mL - 0.9 mL - 1 mL
Warranty	1 year
Spare parts availability	10 years
In compliance with	ISO 7218, ISO 6887, ISO 4833-2 and FDA BAM (Bacteriological Analytical Manual)







DELIVERED WITH

1 user manual, 1 pouch of BagTips® Regular, 1 fixed volume button 1000 µL (on the pipet), 1 holder for key, 2 fixed volume buttons (900 µL, 100 µL), 2 O-Rings, 1 Allen wrench, Oil.

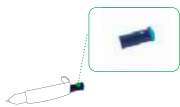
WEIGHT AND DIMENSIONS

BagPipet - Ref. 251 091	
Dimensions (w x d x h)	6 x 18.5 x 3 cm
Net weight	0.15 kg
Box (w x d x h)	30.5 x 10 x 6 cm
Gross weight	0.29 kg

ACCESSORIES

	Ref.	Designation	Description	Qty	Box	
					Dimensions (cm)	Gross weight (kg)
	251 001	Fixed volume button (100 µL)	100 µL fixed volume button for BagPipet®	1	14x8	0.01
	251 009	Fixed volume button (900 µL)	900 µL fixed volume button for BagPipet®	1	14x8	0.01
	251 010	Fixed volume button (1000 µL)	1000 µL fixed volume button for BagPipet®	1	14x8	0.01
	251 080	Variable volume button	Variable volume button 100 to 1000 µL for BagPipet®.	1	14x8	0.01
	252 019	BagTips® Regular	Straw tip (5 to 12 kGy Gamma ray treated) for BagPipet®. Nominal volume: 2 mL - Length: 190 mm	1000	27.5x22.5x11	1.20
	252 024	BagTips® Jumbo	Straw tip (5 to 12 kGy Gamma ray treated) for BagPipet®. Nominal volume: 2.5 mL - Length: 240 mm	1000	27.5x22.5x11	1.20



BagClip®



Closing clip

Quick closing

Ref. 231 010 (80/100 mL)

Ref. 231 040 (400 mL)

Ref. 231 350 (2000/3500 mL)

BagClip® is a temporary closing clip. It fits all types of bag.

MAIN FEATURES

- Quick waterproof closure
- 3 sizes available for 80/100 mL, 400 mL, 2000 mL and 3500 mL bags

APPLICATIONS

BagClip® allows the storage and the temporary closing of any sample preparation bag during microbiological analysis. It is used in the food, pharmaceutical and cosmetic fields.

TECHNICAL SPECIFICATIONS

SPECIFICATIONS	BagClip® 80/100	BagClip® 400	BagClip® 3500
For bags	80 mL and 100 mL	400 mL	2000 mL and 3500 mL
Length (white clip)	130 mm	195 mm	400 mm
Length (green tube)	160 mm	225 mm	450 mm
Box of	50		



Food



Pharmaceutical



Cosmetics

WEIGHT AND DIMENSIONS

Model	Reference	Net weight	Box (w x d x h)	Gross weight
BagClip® 80/100	231 010	0.009 kg	21.5 x 16 x 6.5 cm	0.74 kg
BagClip® 400	231 040	0.013 kg	28.5 x 19.5 x 6.5 cm	0.77 kg
BagClip® 3500	231 350	0.027 kg	50.5 x 11.5 x 10.5 cm	1.57 kg

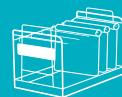

BagOpen®

Bag opener/holder

Ideal for pipetting

Ref. 211 010 (80/100 mL)

Ref. 211 040 (400 - 2000 mL)

Ref. 211 350 (3500 mL)

BagOpen® makes it easy to open the bag and keep it open in a vertical position, without any risk of contamination during handling.

MAIN FEATURES

- **Stable and solid base**
- **Available for bags: 80/100 mL, 400 mL, 2000 mL and 3500 mL**
- **Withstands temperatures up to 65 °C / 149 °F (do not put in an autoclave)**

APPLICATIONS

BagOpen® is useful for all laboratory manipulations, for microbiological analysis in the food, pharmaceutical and cosmetic fields.

WEIGHT AND DIMENSIONS

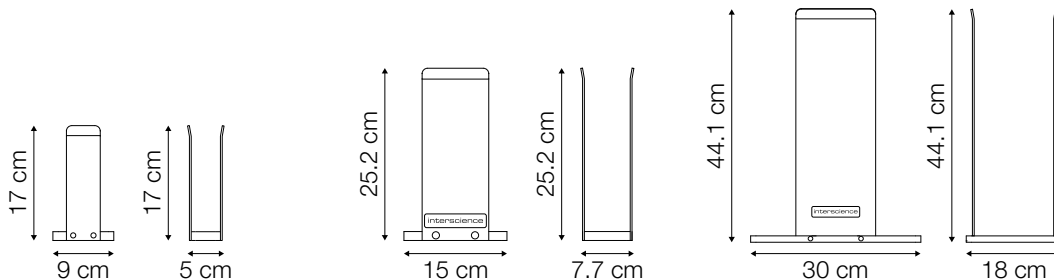

BagOpen® 80/100 - Ref. 211 010		BagOpen® 400 - Ref. 211 040		BagOpen® 3500 - Ref. 211 350	
Net weight	0.20 kg	Net weight	0.40 kg	Net weight	2 kg
Box (w x d x h)	23 x 12 x 5 cm	Box (w x d x h)	26 x 16 x 6.2 cm	Box (w x d x h)	50 x 40 x 40 cm
Gross weight	0.20 kg	Gross weight	0.54 kg	Gross weight	2.10 kg



Food



Pharmaceutical



Cosmetics

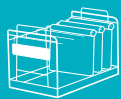

BagSeal®

Thermal sealing unit

Waterproof sealing

Ref. 261 000



BagSeal® is a pulse heat sealer. It seals all types of bag with a wide and solid weld.

MAIN FEATURES

- Large welding: 250 mm x 5 mm
- Adjustable heating power



Food



Pharmaceutical

APPLICATIONS

BagSeal® is used to close films or bags made of polyethylene, polypropylene or various complexes.

- Food products: flavors, additives, spices, dried fruits, peanuts, meat, etc.
- Pharmaceutical products: vitamins, capsules, etc.
- Chemical products: coloring, phytosanitary, etc.

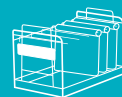

TECHNICAL SPECIFICATIONS

SPECIFICATIONS	
All stainless steel	✓
LED light code at the end of the sealing	✓
Adjustable heating power	✓
For bags	80 mL - 100 mL - 400 mL - 2000 mL
Large sealing	250 x 5 mm
Pressure	22 Newton/cm ²
Voltage and frequency	100-127 V~ / 220-240 V~ 50-60 Hz
Max. power	1600 W
Warranty	1 year
Spare parts availability	10 years
Manufactured under	CE, UKCA, RoHS, WEEE

WEIGHT AND DIMENSIONS

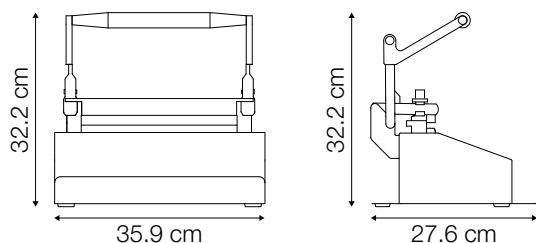

BagSeal® - Ref. 261 000	
Net weight	10.80 kg
Box (w x d x h)	49 x 40 x 49 cm
Gross weight	13.60 kg

ACCESSORIES

	Ref.	Designation	Description	Quantity	Box	
					Dimensions (cm)	
					Gross weight (kg)	
	261 500	Maintenance kit for thermal sealing	2 welding threads + 2 fuses + 2 Teflon cloths	1	35xØ 4	
					0.04	

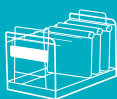

Product compatibility

Product	Model	BagRack® Slide		BagRack®	
		400 mL	80/100 mL	400 mL	3500 mL
GRAVIMETRIC DILUTORS					
DiluFlow®	-	●	● ⁽²⁾	●	
DiluFlow® Pro	-	●	● ⁽²⁾	●	● ⁽¹⁾
DiluFlow® Elite 5 kg	-	●	● ⁽²⁾	●	● ⁽¹⁾
DiluFlow® Elite 1 kg	-	●	● ⁽²⁾	●	
LAB BLENDERS					
MiniMix® 100 P CC	100		●		
MiniMix® 100 W CC	100		●		
BagMixer® 400 P	400	●		●	
BagMixer® 400 W	400	●		●	
BagMixer® 400 CC	400	●		●	
BagMixer® S	400	●		●	
BagMixer® SW	400	●		●	
JumboMix® 3500 P CC	3500				●
JumboMix® 3500 W CC	3500				●
JumboMix® 3500 WarmMix® CC	3500				●
DISPENSING PUMPS					
FlexiPump®	-	●	●	●	●
FlexiPump® Pro	-	●	●	●	●
LAB ACCESSORIES					
BagRack® Slide	400				
BagRack®	100				
	400				
BagPipet®	3500				
	-	●	●	●	●
BagClip®	100		●		
	400	●		●	
	3500				●
BagOpen®	100		●		
	400	●		●	
	3500				●
BagSeal®	-	●	●	●	
BLENDER BAGS WITH FILTER					
BagFilter® Roll	400	●		●	
BagFilter® Pipet	400	●		●	
BagFilter® Pipet & Roll	400	●		●	
BagFilter® P	400	●		●	
	2000				●
	3500				●
BagFilter® S	400	●		●	
BagFilter® Pull-Up	400	●		●	
BagFilter® XF	400	●		●	
BagPage® +	100		●		
	400	●		●	
	2000				●
	3500				●
BagPage® F	400	●		●	
BagPage® R	400	●		●	
BagPage® XR	400	●		●	
BLENDER BAGS WITHOUT FILTER					
BagLight® PolySilk®	100		●		
	400	●		●	
	2000				●
	3500				●
BagLight® Multilayer®	400	●		●	
BLENDER BAGS WITH CULTURE MEDIA					
instaBAG® EPT	400	●		●	
instaBAG® Fraser ½	400	●		●	
	225	●		●	
instaBAG® MILK	900				●
	2250				●
	3375				●
	3375				●
STERILE SAMPLING BAGS					
RollBag®	7.5 x 20		●		
	11 x 20		●		
	11 x 25		●		
	14 x 23		●		
	11 x 30		●		
	14 x 33	●	●	●	
	17.5 x 30	●		●	
	17.5 x 40	●		●	
	25 x 38				●
	25 x 50				●
	38 x 56				●

(1) with Jumbo Kit option (Ref. 505 006) (2) with BagOpen® 80/100 mL option (Ref. 505 014)



Product	PetriPile®			
	55 mm	65 mm	90 mm	150 mm
DISPENSING PUMPS				
FlexiPump®	•	•	•	•
FlexiPump® Pro	•	•	•	•
AUTOMATIC PLATERS				
easySpiral®			•	
easySpiral® Pro			•	•
easySpiral® Pro Milk			•	•
easySpiral® Dilute	•	•	•	•
COLONY COUNTERS				
Scan® 50	•	•	•	•
Scan® 50 Pro	•	•	•	•
Scan® 100	•	•	•	•
Scan® 300			•	
Scan® 500			•	
Scan® 1200	•	•	•	
Scan® 4000	•	•	•	•
INHIBITION ZONE READERS				
Scan® 500 inhibition zone reader			•	
Scan® 1200 inhibition zone reader			•	
Scan® 4000 inhibition zone reader			•	•
REAL-TIME INCUBATOR AND COLONY COUNTERS				
ScanStation® 100	•	•	•	
ScanStation® 200	•	•	•	
ScanStation® 300	•	•	•	

Plate & Count system[®]

Plate & Count system[®] is the optimal solution for your microbiological analysis when you are looking for **efficiency**, **repeatability** and all the guarantees of **traceability**. **This system includes all the steps of bacterial analysis: dilution, plating, incubation and colony counting.**



Automatic platers page 88



dataLink™ traceability system



Colony counters page 104



Incubator and colony counter page 124

75% time savings
No manual dilution with the automatic method.

Results 3x sooner
Petri dishes are counted during the incubation process

Why choose Plate & Count system[®] ?
Comparison between the manual and automatic method

75% waste reduction
on consumables for 150 analyses (tubes, tips, Petri dishes).

Traceability of results assured
Data from plating to counting are traced and archived.

Your data on the edge of the Petri dish

There are three label formats: sample number, barcode, datamatrix.

1. Date and time of plating
2. Sample number
3. Operator code
4. Datamatrix
5. Type of agar or method of analysis
6. Volume of plated sample
7. Plating method



Food



Environmental



Pharmaceutical



Cosmetics



Veterinary



Public research



Automatic platers

A revolution for your serial dilutions!

With easy**Spiral**® automatic platers and the **Spiral**® plating technique, increase your analyses capabilities while reducing sample processing time. The technique offers a counting range from 100 to 1×10^7 CFU/mL on a Petri dish without prior dilution.



The **Spiral**[®] plating technique

The **Spiral**[®] plating technique is a standardized technique of enumeration via plating that **automates Pasteur's practices**. A sample is plated on the surface of a rotating agar plate using a high-precision syringe in a **logarithmically decreasing Archimedean spiral** from the center to the periphery of the Petri dish.

Increase your analysis capacity using the easySpiral[®] platers whose counting range is from 100 to 1x10⁷ CFU/mL on a single Petri dish, and without prior dilution.

Manual plating



Spiral[®] plating

This method requires repetitive actions: at least 4 dilutions and 4 successive platings are necessary to obtain 1 good and readable Petri dish.

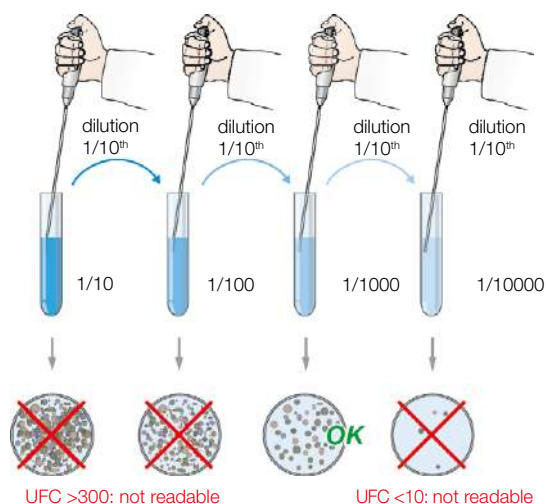

With this plating technique, make your analysis **using only 1 single Petri dish!**



- 100 to 1x10⁷ CFU/mL on 1 single Petri dish
- Less consumables: up to **75% savings**
- Full plating cycle in **25 seconds**

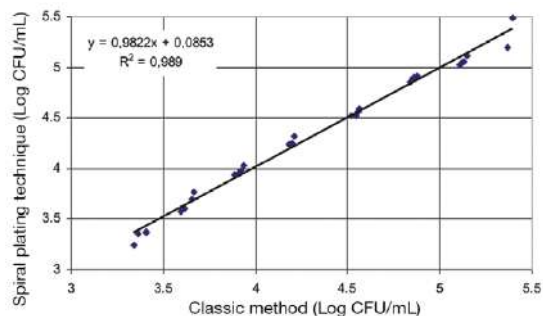
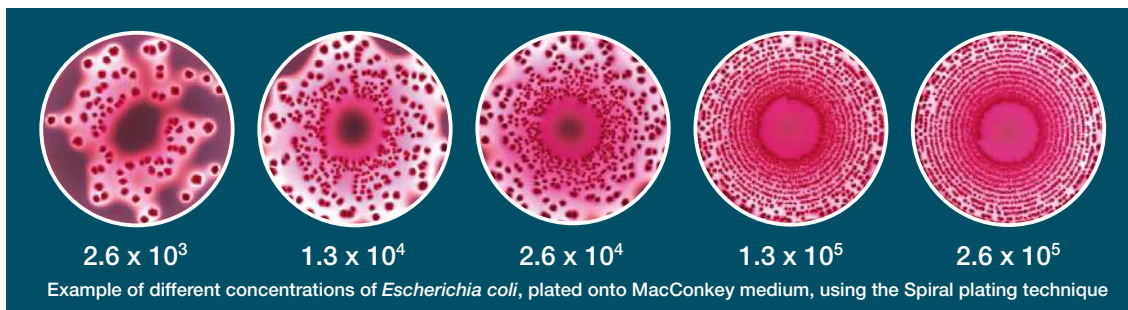

Comparison between the classical method and the Spiral[®] automatic plating technique

The **Spiral**[®] plating technique is a surface plating technique. It is similar to the horizontal methods commonly used in laboratories. Compared to the reference methods, interlaboratory tests such as RAEMA show that there is no significant difference between both methods.

Correlation line between the *Escherichia coli* count (in Log CFU/mL) obtained by plating with the Spiral[®] and conventional methods.

How to count?

The bacterial concentration is determined by dividing the number of counted colonies by the plated volume per sector. CFUs can be counted either manually (using an abacus or any manual colony counter), or automatically using any automatic **Scan**[®] colony counter.



Top features of the range

50% time and consumables savings

1 disinfection, 5 dilutions + 1 plating of a dilution in 134 s.⁽¹⁾

Simplified serial dilutions⁽¹⁾

Automatic dilutions to 10⁻⁵ or more. No longer need to prepare 9 mL tubes.

PATENTED

Spiral[®] technique

Automatic plating with a counting range from 100 to 1 x 10⁷ CFU/mL

For more information, please refer to page 89



Automatic disinfection

Overflow technology. No risk of cross-contamination.

PATENTED

One touch plating

Choose from 4 plating modes⁽¹⁾. Plate 55, 90 and 150 mm Petri dishes.

Traceability ensured with dataLink^{™(1)}

All the sample data are set on the datamatrix label.

(1) Valid according to the model, refer to the technical specifications.

Range overview



Automatic platers

easySpiral®	easySpiral Pro®	easySpiral Pro® Milk	easySpiral Dilute®
Automatic plater	Automatic plater	Automatic plater	Automatic dilutor and plater
Essential features	Traceability guaranteed	Ideal for milk payment	Plater and dilution features

	Top features			
Full plating cycle in 25 s	✓	✓	✓	✓
Stylus disinfection by Overflow PATENTED	✓	✓	✓	✓
Programmable dispensed volume (via USB)	-	✓	✓	✓
Traceability	-	✓	✓	✓
Compatible with dataLink™	-	✓	✓	✓
Sampling in the holder/pillar	-	-	✓	-
Dilution mode PATENTED	-	-	-	✓
Counting range to 1x10 ¹² CFU/mL	-	-	-	✓



easySpiral®

Automatic plater

Essential features

Ref. 412 000



easySpiral® is an automatic plater of Petri dishes. It allows plating of a sample with 300 to 1.3×10^5 CFU/mL on one Petri dish, without prior dilution. Plated volumes are of 50 and 100 μ L.

MAIN FEATURES

- Syringe capacity: 1000 μ L
- Plating modes: exponential, circle
- Counting range: from 300 to 1.3×10^5 CFU/mL
- Plating cycle time: 25 seconds



Food



Pharmaceutical



Cosmetics



Public research

APPLICATIONS

The easySpiral® plater is used for enumeration during microbial control.

The **Spiral**® plating technique is often used for the detection of microorganisms with a quality criterion higher than 100 CFU/g. ISO 4833-2 regulates the use of this technique for the detection of total flora, which requires 4 or more dilutions before plating. The **Spiral**® technique allows for 4 logs dilutions on the same Petri dish.

easySpiral Pro®

Automatic plater

Traceability guaranteed

Ref. 413 000



Automatic platers

easySpiral® Pro is an automatic plater of Petri dishes. It allows plating of a sample of 100 to 1×10^7 CFU/mL on one Petri dish, without prior dilution. Traceability is ensured and volumes are programmable via USB connection.

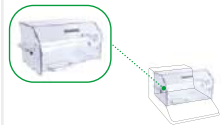

WORK IN CONTROLLED CONDITIONS

Housing protection for platers

Ref. 413 001

[For more information, please refer to page 100](#)

MAIN FEATURES

- Traceability and programmable volumes
- Plating modes: exponential, constant, circle
- Counting range: from 100 to 1×10^7 CFU/mL
- Plating cycle time: 25 seconds

APPLICATIONS

The easySpiral® Pro plater is used for enumeration during microbial control. The Spiral® plating technique is often used for the detection of microorganisms with a quality criterion higher than 100 CFU/g. ISO 4833-2 provides a framework for the use of this technique for the detection of total flora. The constant mode, equivalent to a homogeneous surface plating, allows the enumeration of microorganisms with quality criteria lower than 100 CFU/g.



Food



Pharmaceutical



Cosmetics



Public research



easySpiral Pro[®] Milk



Automatic plater

Ideal for milk payment

Ref. 413 090

easySpiral Pro[®] Milk is an automatic Petri dish plater. It allows plating of a sample of 100 to 1x10⁷ CFU/mL on a single Petri dish, without prior dilution. easySpiral Pro[®] Milk is particularly suitable for the dairy industry in analyzing raw materials and payment for milk.



DIGITALIZE YOUR MILK PAYMENT RESULTS

Scan[®] 1200 - HD automatic colony counter

Ref. 437 000

[For more information, please refer to page 87](#)



Food



Pharmaceutical



Cosmetics



Public research

MAIN FEATURES

- Sample intake in the sample holder
- Plating modes: exponential, pour, circle
- Counting range: from 100 to 1x10⁷ CFU/mL
- Plating cycle time: 25 s

APPLICATIONS

The easySpiral Pro[®] Milk plater is used for enumeration during microbial control of milk samples. The sample can be taken from the original container in a space provided for this purpose. The device is suitable for the payment of milk in order to avoid cross-contamination during transfers. It is also suitable for the collection of any liquid sample for plating on a Petri dish. The ISO 4833-2 defines the use of the **Spiral**[®] plating technique for the detection of total flora.

easySpiral Dilute®



Automatic dilutor and plater

Plater and dilution features

Ref. 414 000

Automatic platers

easy**Spiral** Dilute® is an automatic diluter and plater of Petri dishes. It allows 1/10th serial dilutions and plating up to 6 logs dilution on 1 single Petri dish. For a sample of 30 to 1 x 10¹² bacteria, no more manual dilutions and plating is automatic.



INTEGRATE TRACEABILITY DURING ENUMERATION

Scan® 4000 - Ultra HD automatic colony counter

Ref. 438 000

[For more information, please refer to page 87](#)

MAIN FEATURES

- Automatic cycle of 5 successive dilutions at 1/10th
- Plating modes: exponential, constant, circle, pour plate
- Counting range: from 30 to 1x10¹² CFU/mL
- Plating cycle time: 134 seconds

APPLICATIONS

The easy**Spiral** Dilute® plater is used for enumeration during microbial control. The **Spiral**® plating technique allows 4 logs dilutions on the same plate and the automatic dilution ramp of the device allows for the increase of the enumeration range. This technique is adapted to the realization of challenge-tests requiring several dilutions to the 10th before plating. The **Spiral**® technique is also used for the detection of quality indicators with a criterion higher than 100 CFU/g. The ISO 4833-2 defines the use of this technique for the research of total flora.



Food



Pharmaceutical



Cosmetics



Public research



Technical specifications of the range

	easySpiral®	easySpiral Pro®	easySpiral Pro® Milk	easySpiral Dilute®
OVERVIEW				
Reference	412 000	413 000	413 090	414 000
Controlled by a microprocessor	✓	✓	✓	✓
All stainless steel	✓	✓	✓	✓
Disinfection process	✓	✓	✓	✓
Filling time and volume programmable via USB	-	✓	✓	✓
Sampling from tubes (dim.: 80 x 35 mm)	-	-	✓	-
Sampling from beakers (DB50)	✓	✓	-	✓
My diluent key	-	-	-	✓
Sample mixing before dilution/plating	-	-	-	✓
SPECIFICATIONS				
Number of dilutions at 1/10th for 1 cycle		-		5
Syringe capacity	1000 µL			
Preset dispensed volumes	50 µL and 100 µL	50 µL, 100 µL and 200 µL		
Counting range	300 CFU/mL to 1.3x10 ⁵ CFU/mL	100 CFU/mL to 1x10 ⁷ CFU/mL		30 CFU/mL to 1x10 ¹² CFU/mL
Time for 1 sample intake + 1 disinfection + 1 plating	25 s			
Time for 1 disinfection + 5 dilutions + 1 plating of 1 dilution		-		134 s
Time for 1 disinfection + 5 dilutions + 1 plating of each dilution		-		234 s
Pressure in the stylus	Up to 8 bars			
Autonomy in disinfection (in normal mode)	1000 cycles (2 L bottles)			
Autonomy in distilled water (in normal mode)	600 cycles (2 L bottles)			-
Autonomy in diluents		-		63 cycles (2 L bottles)
Approved diluents		-		Saline water, Ringer solution
Successive plating capacity with the same sample	Up to 20 Petri dishes (50 µL)			
Exponential plating mode (Spiral® mode): Petri dish diameters Ø available	90 mm	90 mm and 150 mm		



	easySpiral®	easySpiral Pro®	easySpiral Pro® Milk	easySpiral Dilute®
SPECIFICATIONS				
Circle plating mode: Petri dish diameters Ø available	90 mm	90 mm and 150 mm		3 dilutions on a 90 mm and 6 dilutions on a 150 mm
Constant plating mode: Petri dish diameters Ø available	-	90 mm and 150 mm		55 mm, 90 mm and 150 mm
Pour plating mode: Petri dish diameters Ø available		-		55 mm, 90 mm and 150 mm
Programmable dispensed volume (via USB)	-	10 µL to 1000 µL		
Voltage - Frequency	100-240 V~ 50-60 Hz			
Warranty	1 year			
Spare parts availability	10 years			
In compliance with	ISO 7218, ISO 4833-2, FDA BAM (Bacteriological Analytical Manual) and AOAC 977.27			
Manufactured under	CE, UKCA, RoHS, WEEE			
TRACEABILITY				
Traceability	-	Excel™, LIMS, dataLink®		

DELIVERED WITH

easySpiral®: 1 turntable ring for Ø 90 mm Petri dishes (by default on the unit), 1 blue dye for testing, 1 syringe with silicone tubing, 1 Spiral® counting grid for Ø 90 mm Petri dishes, 1 container stand for testing, 1 set of 2 filters, 1000 DB50 beakers, 1 EnzyClear® liquid detergent, 4 connection kits for GL45 bottle, 1 double connection kit for GL45 bottles, 1 stylus, 1 power cable, 1 user manual, 1 EnzyClear® quick user guide, 1 conformity certificate / warranty card.

easySpiral Pro®: 1 turntable ring for Ø 90 mm Petri dishes (by default on the unit), 1 blue dye for testing, 1 syringe with silicone tubing, 1 plating ring for Ø 150 mm Petri dishes, 1 Spiral® counting grid for Ø 90 mm Petri dishes, 1 container stand for testing, 1 set of 2 filters, 1 software, 1 USB cable A/B, 1 Spiral® counting grid for Ø 150 mm Petri dishes, 1000 DB50 beakers, 1 EnzyClear® liquid detergent, 4 connection kits for GL45 bottle, 1 double kit for GL45 bottles, 1 stylus, 1 power cable, 1 user manual, 1 EnzyClear® quick user guide, 1 conformity certificate / warranty card.

easySpiral Pro Milk®: 1 turntable for Ø 90 mm Petri dishes (by default on the unit), 1 blue dye for testing, 1 syringe with silicone tubing, 1 plating ring for Ø 150 mm Petri dishes, 1 Spiral® counting grid for Ø 90 mm Petri dishes, 1 container stand for testing, 1 set of 2 filters, 1 software, 1 USB cable A/B, 1 Spiral® counting grid for Ø 150 mm Petri dishes, 1 EnzyClear® liquid detergent, 4 connection kit for GL45 bottle, 1 double connection kit for GL45 bottle, 1 stylus, 1 power cable, 1 user manual, 1 EnzyClear® quick user guide, 1 conformity certificate / warranty card.

easySpiral Dilute®: 1 turntable ring for Ø 90 mm Petri dishes (by default on the unit), 1 blue dye for testing, 1 syringe with silicone tubing, 1 plating ring for Ø 55 mm Petri dishes, 1 plating ring for Ø 150 mm Petri dishes, 1 Spiral® counting grid for Ø 90 mm Petri dishes, 1 circle mode counting grid for Ø 90 mm Petri dish, 1 set of 2 filters, 1 software, 1 USB cable A/B, 1 Spiral counting grid for Ø 150 mm Petri dishes, 1 circle mode counting grid for Ø 150 mm Petri dish, 1000 DB50 beakers, 1 EnzyClear® liquid detergent, 4 connection kits for GL45 bottle, 1 double kit for GL45 bottles, 1 stylus, 1 power cable, 1 user manual, 1 EnzyClear® quick user guide, 1 conformity certificate / warranty card.



WEIGHT AND DIMENSIONS

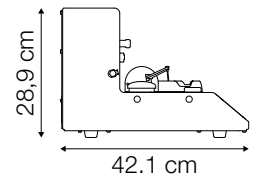
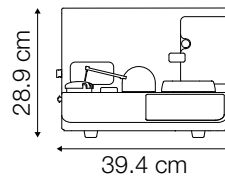
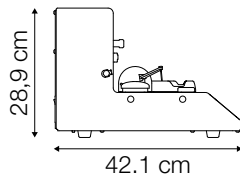
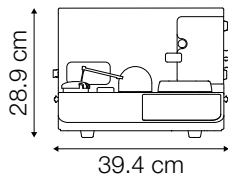

easySpiral® - Ref. 412 000

Net weight	16.30 kg
Box (w x d x h)	60 x 50 x 55 cm
Gross weight	25.40 kg

easySpiral Pro® - Ref. 413 000

Net weight	16.30 kg
Box (w x d x h)	60 x 50 x 55 cm
Gross weight	25.90 kg

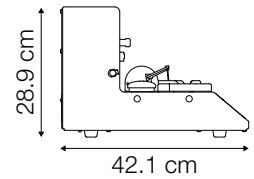
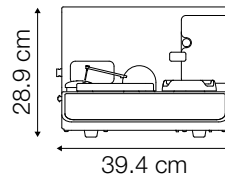
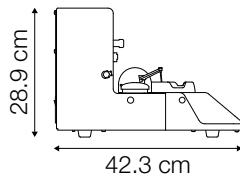
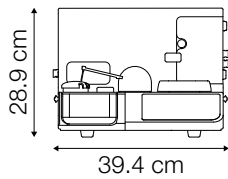

easySpiral Pro® Milk - Ref. 413 090

Net weight	16.30 kg
Box (w x d x h)	60 x 50 x 55 cm
Gross weight	25.90 kg

easySpiral Dilute® - Ref. 414 000

Net weight	16.60 kg
Box (w x d x h)	60 x 50 x 55 cm
Gross weight	26.70 kg

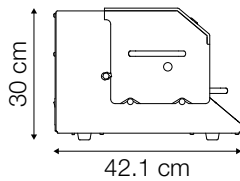
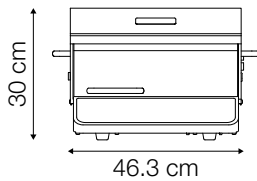

easySpiral Dilute® + Housing protection Ref. 414 000 + Ref. 413 001

Net weight	18.60 kg	
Box (w x d x h) (2 boxes)	easySpiral Dilute®: 60 x 50 x 55 cm	Housing protection: 59 x 37 x 29 cm
Gross weight (2 boxes)	easySpiral Dilute®: 26.70 kg	Housing protection: 3.20 kg

Product compatibility







Product	Model	easySpiral®	easySpiral Pro®	easySpiral Pro® Milk	easySpiral Dilute®
LAB ACCESSORIES					
PetriPile®	55				•
	65				•
	90	•	•	•	•
	150		•	•	•
COLONY COUNTERS					
Scan® 100	-	•	•	•	•
Scan® 300	-	•	•	•	•
Scan® 500	-	•	•	•	•
Scan® 1200	-	•	•	•	•
Scan® 4000	-	•	•	•	•
REAL-TIME INCUBATOR AND COLONY COUNTER					
ScanStation® 100	-	•	•	•	•
ScanStation® 200	-	•	•	•	•
ScanStation® 300	-	•	•	•	•



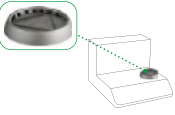
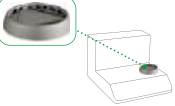
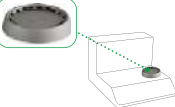
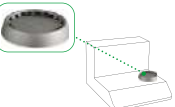
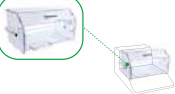

Automatic platers

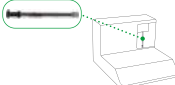

Accessories

	Ref.	Designation	Description	Qty	Box		easySpiral®	easySpiral Pro®	easySpiral Pro® Milk	easySpiral Dilute®
					Dimensions (cm)	Gross weight (kg)				
	410 100	dataLink™	Complete traceability system for Petri dishes from sampling on easySpiral Pro®/Pro® Milk/Dilute® to the automatic colony counting of the Scan® 300/500/1200/4000. It includes software, thermal printer, 2D / 3D code reader, 2x2500 labels.	1	48.5x38.5x25	5.20		•	•	•
	410 120	Stickers for printer	2 rolls of 2500 labels for thermal printer - Label size: 45 x 10 mm	2	18x25	0.47		•	•	•
	410 130	Film for printer	Thermal transfer film	1	12x10x8	0.08		•	•	•
	412 010	Plate for Petri dish (50-60 mm)	Multiadaptable support for Petri dishes from Ø 50 to 60 mm	1	25x10x10	0.30				•
	412 011	Plate for Petri dish (60-70 mm)	Multiadaptable support for Petri dishes from Ø 60 to 70 mm	1	25x10x10	0.30				•
	412 012	Plate for Petri dish (70-80 mm)	Multiadaptable support for Petri dishes from Ø 70 to 80 mm	1	25x10x10	0.30				•
	412 013	Plate for Petri dish (80-90 mm)	Multiadaptable support for Petri dishes from Ø 80 to 90 mm	1	25x10x10	0.30				•
	413 001	Housing protection for platers	Transparent housing for working outside laminar flow	1	59x37x29	3.20	•	•		•
	413 002	2L bottle (GL45)	Set of 3 GL45 glass bottle (2L), autoclavable	3	37x37x37	4.10	•	•	•	•

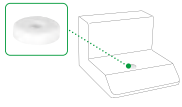

	Ref.	Designation	Description	Qty	Box		easySpiral®	easySpiral Pro®	easySpiral Pro® Milk	easySpiral Dilute®
					Dimensions (cm)	Gross weight (kg)				
	413 004	Syringe (1mL)	Syringe (capacity 1000 µL)	1	25x10x10	0.03	•	•	•	•
	413 014	Spiral® counting grid (90 mm)	Spiral® counting grid for Ø 90 mm Petri dishes	1	25x10x3	0.12	•	•	•	•
	413 015	Spiral® counting grid (150 mm)	Spiral® counting grid for Ø 150 mm Petri dishes	1	25x20x3	0.20	•	•	•	•
	413 016	Support for Eppendorf™ 0.5 mL	Support for Eppendorf™ - Sample intake 0.5 mL	1	12x10x8	0.05	•	•		
	413 017	Support for Eppendorf™ 1.5 mL and 2 mL	Support for Eppendorf™ - Sample intake 1.5 mL and 2 mL	1	12x10x8	0.05	•	•		
	413 018	Support for Dilucup™	Support for Dilucup™ sample intake	1	12x10x8	0.02	•	•		
	413 019	Adjustable plate for Petri dish (90-150 mm)	Multiadaptable support for Petri dishes of 90 to 150 mm	1	25x10x10	0.25	•	•	•	•
	413 026	Circle counting grid (90 mm)	Circle mode counting grid for Ø 90 mm Petri dishes	1	25x20x3	0.12				•
	413 027	Circle counting grid (150 mm)	Circle mode counting grid for Ø 150 mm Petri dishes	1	25x20x3	0.20				•
	413 029	EnzyClear®	Spiral® plater detergent recommended for cleaning and pre-disinfection. Pot of 300 g	1	Ø 90 H: 11	0.37	•	•	•	•









Automatic platers

	Ref.	Designation	Description	Qty	Box	easySpiral®	easySpiral Pro®	easySpiral Pro® Milk	easySpiral Dilute®
					Dimensions (cm)				
					Gross weight (kg)				
	413 030	500 mL bottle (GL45)	GL45 glass bottle (500 mL), autoclavable	1	20x10x10	•	•	•	•
					0.5				
	414 001	Stylus (1 mL)	Stylus 1 mL	1	25x10x10	•	•	•	•
					0.28				
	414 002	Support for Eppendorf™ (1.5 mL)	Support for Eppendorf™ Sample intake 1.5 mL for easySpiral Dilute®	1	20x17x7				•
					0.25				
	414 003	Maintenance kit for platers (1 mL)	Maintenance kit including: 1 stylus, 1 syringe, 1 silicone tubing (ref 413 006), 1 grease tube, 8 filters, 2 quick connectors	1	31x21.5x10	•	•	•	•
					0.52				
	415 100	Beakers (DB 50)	Beakers for Spiral® plater (5 mL)	1000	34x22x12	•	•		•
					1.50				
	415 530	Blue dye for platers	Color dye for Spiral tests (125 mL)	1	12x10x8	•	•	•	•
					0.15				
	439 050	dataLink® pro	Traceability system with semi-automated labeling. The pack contains 1 printer, 1 power cord, 1 USB cable, 2 user's manuals, 1 thermal transfer film (ref. 439 052), 1 core, 3 rolls of 2500 adhesive labels (ref. 439 051), 1 USB key with the monitoring software	1	71 x 36 x 41.5				•
					16				
	439 051	Stickers for printer (dataLink® pro)	Set of 3 Labels roll for dataLink® pro printer - Label size: 5x50mm - Qty : 3x2500	3x2500	25.7x21.5 x10.5				•
					0.60				
	439 052	Film for printer (dataLink® pro)	Thermal transfer film for dataLink® pro printer	1	12.88x11.5 x8.5				•
					0.22				
	522 000	Bar-code reader	Bar-code reader (1D/2D)	1	26x16.5x11				•
					0.66				

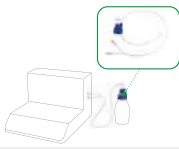

Tubings

	Ref.	Designation	Description	Qty	Box				
					Dimensions (cm)	easySpiral®	easySpiral Pro®	easySpiral Pro® Milk	easySpiral Dilute®
	413 003	Connection kit for GL45 bottle	Autoclavable connection set for GL45 bottle	1	12x10x8	•	•	•	•
					0.08				
	413 006	Tubings	Silicone tubing with filter for cleaning pump	1	12x10x8	•	•	•	•
					0.04				
	413 009	Filters for rinsing bath	Set of 2 filters for rinsing bath	2	12x10x8	•	•	•	•
					0.02				
	413 028	Tube weights (Ø 3 mm)	Set of 5 tube weights (inner Ø 3 mm)	5	12x8	•	•	•	•
					0.04				
	414 004	Double connection kit for GL45 bottle	Double connection kit for GL45 bottle to be used on the same bottle	1	18x25	•	•	•	•
					0.08				
	513 023	PTFE filters 0.2 µm (Ø 25 mm)	Set of 5 autoclavable filters (0.2 µm) for GL45 bottle	5	12x10x8	•	•	•	•
					0.02				



interscience

Scan 4000

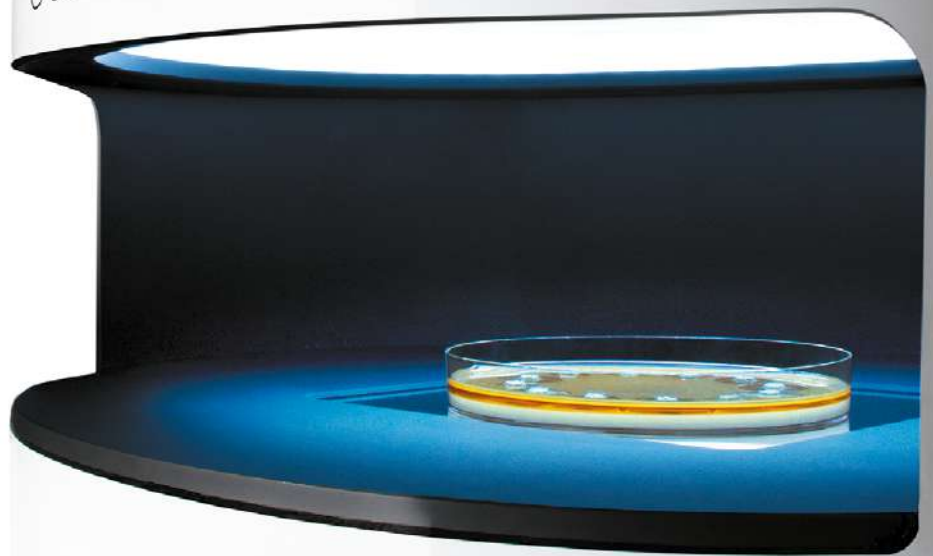

Colony counters and inhibition zone readers

Performance and traceability of analyses

Counting colonies and reading inhibition zones is time consuming. **Scan**[®] colony counters and inhibition zone readers provide fast, complete and accurate analyses. Traceability of all results is assured.



Advantages of the colony counter range

Accuracy and repeatability

Scan[®] counts up to 1000 colonies in 1 s with consistency and repeatability. Up to 98% counting accuracy.⁽¹⁾

Traceability

Data can be imported in the **Scan**[®]. The results and counting parameters are saved and exported.⁽¹⁾

Reflection and shadow free

Indirect LED lighting diffuses the light and enhances the vision of the colonies on the surface, in mass and on the edges of the dish.⁽¹⁾



Ergonomics

The colony counters have been specifically designed to improve the comfort of the operator during the counting process.⁽¹⁾

21 CFR Part 11 included

The **Scan**[®] software complies with FDA recommendations, particularly on audit trail and security of results.

The widest reading range

Scan[®] counts on round Petri dishes from Ø 55 to 150 mm and 120 mm squares. Compatible with multiple media.⁽¹⁾

(1) Valid according to the model, refer to the technical specifications.

Colony counters range overview



NEW	NEW	
Scan® 50	Scan® 50 pro	Scan® 100
Manual colony counters		
Easy-to-use	Great ergonomics	The classic

	Top features		
Stainless steel body	✓	✓	✓
Counting on pour, surface, Spiral® and circle plated Petri dishes	✓ (manual)	✓ (manual)	✓ (manual)
Counting on chromogenic dishes	✓ (manual)	✓ (manual)	✓ (manual)
Counting on Petrifilm™, Compact Dry™, MC-Media Pads™, Easy Plate™, filtration membranes	✓ (manual)	✓ (manual)	✓ (manual)
Color camera and automatic counting	-	-	-
Inhibition zone reading	-	-	-
Minimal size of colony: 0.05 mm	-	-	-
Counting on Petri dishes up to 150 mm	-	-	✓ (manual)
Reflection-free LED lighting	✓	✓	-



Scan® 300	Scan® 500	Scan® 1200	Scan® 4000
Automatic colony counters			
Essential features	Efficiency	High-performance	Unequaled image quality

Top features			
✓	✓	✓	✓
✓	✓	✓	✓
-	✓	✓	✓
-	✓	✓	✓
✓	✓	✓	✓
-	✓	✓	✓
-	-	✓	✓
-	-	-	✓
-	-	-	✓

Colony counters and inhibition zone readers

Advantages of inhibition zone readers

Colony counters
and inhibition zone readers

Quick results

Scan[®] reads up to 16 antibiotics on a Petri dish in just 2-4 s.⁽¹⁾
Result categorized SIR: green (susceptible), yellow (intermediate), red (resistant).

Warranty

Scan[®] Inhibition zone readers are warranted for parts and maintenance for 3 YEARS upon card return.

Detection on all Petri dishes

Scan[®] automatically detects the petri-cylinders, present/removed, made of steel/plastic. It also reads agar wells or paper disks (any brand).



Traceability

The data can be imported into **Scan**[®]. The results and parameters are saved and exported.⁽¹⁾

Integrated databases

Scan[®] is equipped with a fixed set of database of antibiotics (CA-SFM 2020, EUCAST 2020 and CLSI). One of them is customizable.

Printed results

All data, images, photos and results are exportable in printed reports, sca, pdf, jpg, xls, csv.

⁽¹⁾ Valid according to the model, refer to the technical specifications.

Inhibition zone readers overview



Scan® 500	Scan® 1200	Scan® 4000
Inhibition zone reader		
Efficiency	High-performance	State-of-the-art technology

	Top features		
Stainless steel body	✓	✓	✓
Suitable for protocols: agar wells, peni-cylinders, discs	✓	✓	✓
Color camera and automatic counting	✓	✓	✓
Inhibition zone measurement	✓	✓	✓
Inhibition zone measurement accuracy: ± 0.2 mm	-	-	✓
Reading up to 16 antibiotics	-	-	✓

Colony counters
and inhibition zone readers



NEW

Scan® 50

Manual colony counter



Easy-to-use

Ref. 435 050

Scan® 50 is a manual colony counter with improved ergonomics that help prevent Musculoskeletal Disorders. It offers contrasting illumination of colonies while protecting the user's eyes. Traceability is ensured by a USB port.



Food



Environmental



Pharmaceutical



Cosmetics



Veterinary



Public research



FOR AUDITORY COMFORT

Headphones

Ref. 435 052

For more information, please refer to page 122

MAIN FEATURES

- Counting on Petri dishes (Ø 55 to 90 mm), Petrifilm™, MC-media Pads™, Compact Dry™, Easy Plate™, filtration membranes
- Dark Field 2: Indirect LED lighting
- Data export via USB, LIMS, under CSV format (Excel™) or text format (Word™)
- Attention: the magnifying lens is optional (ref. 435 001)

APPLICATIONS

Scan® 50 is used for microbiological analyses in the food industry, pharmaceutical, cosmetic, environmental, veterinary and public institutes. Its Dark Field 2 system facilitates enumeration on Petri dishes by optimising the contrast, especially when analyzing samples for environmental monitoring or quality control of finished products.

NEW

Scan[®] 50 pro

Manual colony counter
with HandPad

Great ergonomics

Ref. 435 055



Colony counters
and inhibition zone readers

Scan[®] 50 pro is a manual colony counter with HandPad and multiple ergonomic supports for improved posture, vision and hearing. It offers a contrasted lighting of the colonies while protecting the eyes. The export of the counting result, by USB to a computer, ensures the traceability of the data.

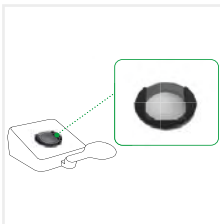

FOR DEHYDRATED MEDIA

Adaptor for Petrifilm[™]/MC-Media Pads[™]/Compact Dry[™]
Ref. 435 051

[For more information, please refer to page 122](#)

MAIN FEATURES

- Counting on Petri dishes (Ø 55 to 90 mm), Petrifilm[™], MC-media Pads[™], Compact Dry[™], Easy Plate[™], filtration membranes
- Dark Field 2: Indirect LED lighting
- HandPad: Ergonomic arm rest
- Data export via USB, LIMS, under CSV format (Excel[™]) or text format (Word[™])
- Headphones included
- Patent pending
- Attention: the magnifying lens is optional (ref. 435 001)

APPLICATIONS

Scan[®] 50 pro is used for microbiological analyses in the food, pharmaceutical, cosmetic, environmental, veterinary industries and public research institutes. Its Dark Field 2 system facilitates enumeration on Petri dishes by optimising the contrast, especially when analyzing samples for environmental monitoring or quality control of finished products.



Food



Environmental



Pharmaceutical



Cosmetics



Veterinary



Public research



Scan® 100

Manual colony counter



The classic

Ref. 435 000

Scan® 100 enables the accurate counting of colonies on any type of media. The integrated USB key allows for the export of results to guarantee traceability.



Food



Environmental



Pharmaceutical



Cosmetics



Veterinary



Public research



FOR INCREASED VISUAL COMFORT: 80% OF CUSTOMERS CHOICE

Magnifying lens

Ref. 435 001

For more information, please refer to page 121

MAIN FEATURES

- Counting on Petri dishes (Ø 55 to 150 mm), PetriFilm™, MC-media Pads™, Compact Dry™, filtration membranes
- White LED lighting with adjustable intensity
- Data export via USB, LIMS, under CSV format (Excel™) or text format (Word™)
- Attention: the magnifying lens is optional (ref. 435 001)

APPLICATIONS

The **Scan® 100** colony counter is used in the food, environmental, pharmaceutical, cosmetic, animal health industries and public research institutes. It facilitates enumeration on Petri dishes, in particular during the analysis of quality indicators or when enumerating colonies in drinking water samples that are difficult to visualize.

Scan® 300

Automatic colony counter



Essential features

Ref. 436 300



Colony counters
and inhibition zone readers

Scan® 300 is an automatic colony counter that includes the essential features for Petri dish counting. It is specifically adapted to the usual media in food microbiology: PCA, MRS...

MAIN FEATURES

- Minimum size of detected colony: 0.1 mm
- Camera: 1 megapixel - zoom x 28
- Counting on round Petri dishes of Ø 55 - 90 mm
- Counting on pour, surface, **Spiral®**, circle mode plated dishes
- Software language: English, French, Japanese, Chinese, Russian, Spanish, German

APPLICATIONS

The **Scan® 300** colony counter is used to read Petri dishes plated manually or with the **Spiral®** method. It implements the interpretation of the **Spiral®** technique, in particular for total flora on PCA according to the ISO 4233-2 standard.



Food



Environmental



Pharmaceutical



Cosmetics



Veterinary



Public research



Scan® 500

Automatic colony counter
and inhibition zone reader



Efficiency

Ref. 436 000

Scan® 500 is an automatic colony counter that ensures fast and efficient counting of colonies, including on chromogenic agar. It guarantees excellent reproducibility. The images and results are saved and usable anytime. **Scan® 500** is also an inhibition zone reader.



Food



Environmental



Pharmaceutical



Cosmetics



Veterinary



Public research

MAIN FEATURES

- Minimum size of detected colony: 0.1 mm
- Camera: 1 megapixel - zoom x 28
- Counting on Ø 55 - 90 mm round Petri dishes
- Counting on pour, surface, Spiral®, circle mode plated Petri dishes
- Counting on chromogenic agar
- Inhibition zone measurement accuracy: ± 0.3 mm
- Protocols: wells, peni-cylinders, paper disks
- Interpretation systems: EUCAST, CA-SFM, CLSI and customizable

APPLICATIONS

Scan® 500 is used to read Petri dishes plated manually or using the Spiral® technique. It allows detection of chromogenic media and enumeration of colored colonies such as positive β - glucuronidase *Escherichia coli* on TBX in food processing analyses.

Scan® 500 measures inhibition zones and provides information on antibiotics in different fields. It is used to determine the impact of the antibiotic in the environment for fundamental research. In the field of animal health, **Scan®** assesses antibiotic resistance with its interpretation according to CASFM/veto, EUCAST and CLSI guidelines.

Scan[®] 1200

HD automatic colony counter
and inhibition zone reader



High-performance

Ref. 437 000



Colony counters
and inhibition zone readers

Scan[®] 1200 is an HD automatic colony counter. It adapts itself to all media and counts in 1 click all colonies, even the smallest ones. It ensures accuracy and excellent reproducibility. Images and results are saved automatically. **Scan[®] 1200** is also an inhibition zone reader.

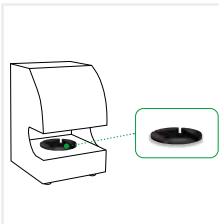

FOR DEHYDRATED MEDIA

Adaptor for Petrifilm[™]

Ref. 437 002

[For more information, please refer to page 122](#)



Food



Environmental



Pharmaceutical



Cosmetics



Veterinary



Public research

MAIN FEATURES

- Minimum size of detected colony: 0.05 mm
- Camera: 1.2 megapixels - zoom x 28
- Counting on Ø 55 - 90 mm round Petri dishes
- Counting on pour, surface, Spiral[®], circle mode plated Petri dishes
- Counting on chromogenic agar, Petrifilm[™], MC-media Pads[™], Compact Dry[™], Easy Plate[™], filtration membranes
- Inhibition zone measurement accuracy: ± 0.3 mm
- Protocols: wells, peni-cylinders, paper disks
- Interpretation systems: EUCAST, CA-SFM, CLSI and customizable

APPLICATIONS

Scan[®] 1200 is used for reading Petri dishes or various culture media such as filtration membranes for liquid samples and Petrifilm[™] in Quality Control. Interpretation on chromogenic media is also available.

Scan[®] 1200 measures zones of inhibition and provides information on antibiotics in various areas.



Scan® 4000



Ultra-HD automatic
colony counter and inhibition
zone reader

Unequaled image quality

Ref. 438 000

Scan® 4000 is an automatic HD color colony counter. It is adapted to all sizes of Petri dishes and any culture media. Its indirect lighting system gives great user comfort, high accuracy and excellent reproducibility. **Scan® 4000** is also an inhibition zone reader.



DATA INTEGRITY FOR COLONY COUNTING

dataLink®
Ref. 410 100

For more information, please refer to pagepage 121



Food



Environmental



Pharmaceutical



Cosmetics



Veterinary



Public research

MAIN FEATURES

- Minimum size of detected colony: 0.05 mm
- Camera: 5 megapixels - zoom x 69
- Counting on Ø 55 to 150 mm round Petri dishes and 120 mm square Petri dishes
- Counting on pour, surface, Spiral®, circle mode plated dishes
- Counting on chromogenic agar, Petrifilm™, MC-media Pads™, Compact Dry™, Easy Plate™, filtration membranes
- Inhibition zone measurement accuracy: ± 0.2 mm
- Protocols: wells, peni-cylinders, paper disks
- Interpretation systems: EUCAST, CA-SFM, CLSI and customizable

APPLICATIONS

Scan® 4000 is used for reading all sizes of Petri dishes, up to 150 mm. The **Spiral®** technique, which offers up to 6 logs dilutions on a 150 mm Petri dish, can be interpreted by **Scan® 4000**. It also allows the reading of different culture media such as filtration membranes for liquid samples or Petrifilm™ for quality control. Interpretation on chromogenic media is also available.

Scan® 4000 measures inhibition zones and adapts to protocols in 90 mm or 120 mm square dishes. It is used for antibiotic naming and/or dosing in the pharmaceutical industry. In the field of animal health, the **Scan®** assesses antibiotic resistance with its SIR interpretation according to CASFM/ veto, EUCAST and CLSI guidelines and offers the possibility to customize your BDD.



Technical specifications of the range

Colony counters
and inhibition zone readers

	Scan® 50	Scan® 50 pro	Scan® 100	Scan® 300	Scan® 500	Scan® 1200	Scan® 4000
OVERVIEW							
Reference	435 050	435 055	435 000	436 300	436 000	437 000	438 000
Stainless steel outer shell	✓	✓	✓	✓	✓	✓	✓
LIMS/SIL connection	✓	✓	✓	✓	✓	✓	✓
USB connection	✓	✓	✓	✓	✓	✓	✓
Available with dataLink™ / dataLink™ pro traceability system	-	-	-	✓	✓	✓	✓
Counting on pour, surface, Spiral® and circle plated Petri dishes	✓ (manual)	✓ (manual)	✓ (manual)	✓	✓	✓	✓
Counting on chromogenic dishes	✓ (manual)	✓ (manual)	✓ (manual)	-	✓	✓	✓
Counting on Petrifilm™, Compact Dry™, MC-Media Pads™, Easy Plate™, filtration membranes	✓ (manual)	✓ (manual)	✓ (manual)	-	-	✓	✓
Automatic counting	-	-	-	✓	✓	✓	✓
Inhibition zone reader	-	-	-	-	✓	✓	✓
Minimal size of colony: 0.05 mm	-	-	-	-	-	✓	✓
Automatic detection of Petri dishes	-	-	-	-	-	-	✓
Counting on 100% of the Petri dish	✓	✓	-	-	-	-	✓
White LED lighting without reflections	✓	✓	-	-	-	-	✓
HandPad: ergonomic arm-rest	-	✓	-	-	-	-	-
Headphones included	-	✓	-	-	-	-	-
COUNTING							
Counting	Manual (0-1999 CFU)		Manual (0-1998 CFU)	Automatic with manual control			
Automatic separation of clustered colonies	-	-	-	✓	✓	✓	✓
Creation of polygonal exclusion zones	-	-	-	✓	✓	✓	✓
Manual control to add or subtract colonies	✓	✓	✓	✓	✓	✓	✓
Counting light signal	✓	✓	-	-	-	-	-
Counting on Petri dishes up to 150 mm	-	-	✓ (manual)	-	-	-	✓
Adjustable counting beeps	9 different sounds / 5 volume levels		4 volume levels	-	-	-	-
Counting zone	Touch surface with adjustable sensitivity			-	-	-	-
Counting time	-	-	-	Up to 1000 colonies per second			
Minimal size of colony	-	-	-	0.1 mm		0.05 mm	



Colony counters and inhibition zone readers

	Scan® 50	Scan® 50 pro	Scan® 100	Scan® 300	Scan® 500	Scan® 1200	Scan® 4000
INHIBITION ZONE READING							
Antibiotic disc detection	-	-	-	-	Automatic with possibility to add or remove manually antibiotics		
Automatic detection of antibiogram support	-	-	-	-	Disks (several brands simultaneously), wells, petri-cylinder (steel, plastic)		
Display resolution	-	-	-	-	± 0.1 mm		
Inhibition zone measurement accuracy	-	-	-	-	± 0.3 mm	± 0.2 mm	
Number of antibiotic paper disks	-	-	-	-	Up to 7 antibiotics on a Ø 90 mm Petri dish	Up to 16 antibiotics on 120 mm square dish	
Reading time	-	-	-	-	7 inhibition zone reading between 1 to 3 s	16 inhibition zone reading between 2 to 4 s max.	
Interpretation system	-	-	-	-	CA-SFM Human health / EUCAST / CA-SFM Veterinary / CLSI (Clinical, Laboratory Standards Institute) / Customizable list		
SPECIFICATIONS							
Color camera	-	-	-	CMOS		HD CCD	Ultra HD CMOS
Lens	-	-	-	M12 Lens		HD Japanese lens	
Zoom	-	-	-	x 28			x 69
Resolution (megapixels)	-	-	-	1		1.2	5
White LED Lighting technology	Dark Field 2		Dark Field				White LED Dome
LED Lighting system	5 intensity levels		Adjustable intensity	Automatic with 6 combinations, top and/or bottom light, white or black background			Automatic with 7 combinations, top and/or bottom light, white or black background
Petri dish size	Ø 55 mm - Ø 90 mm		Ø 55 mm, Ø 65 mm, Ø 90 mm and Ø 150 mm	Ø 55 mm - Ø 90 mm			Ø 55 mm to 150 mm round Petri dishes and 120 mm square Petri dishes
Color detection	-	-	-	-	7 colors on the same dish + 1 color to exclude		
Languages	-	-	-	English, French, Japanese, Chinese, Russian, Spanish, German			
Voltage - Frequencies	100-240 V~ 50-60 Hz						
Warranty	3 years (after recording the warranty card)						
Spare parts availability	10 years						
Software updates	-	-	-	3 years (after recording the warranty card)			
In compliance with	ISO 7218 and FDA BAM (Bacteriological Analytical Manual)			21 CFR Part 11, ISO 7218 and AOAC 977.27			
Manufactured under	CE, UKCA, RoHS, WEEE						



	Scan® 50	Scan® 50 pro	Scan® 100	Scan® 300	Scan® 500	Scan® 1200	Scan® 4000
TRACEABILITY							
USB Data export	To LIMS, as CSV spreadsheet (Excel™) or text file (Word™)			To LIMS, PDF report, jpg, png and bmp images, Excel™ recountable session			
Data security	-	-	-	Modified data traceability in conformity with 21 CFR part 11			
Results/traceability	Counting result / sample number (with barcode reader connected)		-	Image / sample number / comments / date / time	Image / sample number / comments / date / time / antibiotic name / bacterial name / diameter read / SIR categorized result with color code / minimum and maximum critical diameter		
PC MINIMUM REQUIREMENTS							
Operating system	-	-	-	Windows™ 10 or 11 (or higher)			
Processor	-	-	-	Intel i5, 2.8 GHz, Quad-Core or higher			
RAM	-	-	-	4 GB for use of the Scan			
Equipments	-	-	-	1 USB port free			
Screen	-	-	-	1280 X 1024 pixels or higher			

DELIVERED WITH

Scan® 50: 1 power cord, 1 USB cable, 1 black marker pen, 1 white diffusing background, 1 user manual, 1 conformity certificate / warranty card. **Attention: the magnifying lens is optional (ref. 435 001)**

Scan® 50 pro: 1 power cord, 1 USB cable, 1 black marker pen, 1 white diffusing background, 1 user manual, headphones, 1 conformity certificate / warranty card. **Attention: the magnifying lens is optional (ref. 435 001)**

Scan® 100: 1 white diffusing grid, 1 Ø 90 mm Petri dish adapter, 1 black marker pen, 1 power cable, 1 USB cable, 1 quick user guide, 1 conformity certificate / warranty card. **Attention: the magnifying lens is optional (ref. 435 001)**

Scan® 300: 1 Scan® software, 1 15V power supply, 1 USB cable, 2 validation plates, 1 user manual, 1 conformity certificate / warranty card.

Scan® 500, Scan® 1200, Scan® 4000: 1 Scan® software, 1 15V power supply, 1 USB cable, 3 validation plates, 1 user manual, 1 conformity certificate / warranty card.

WEIGHT AND DIMENSIONS



Scan 50® - Ref. 435 050	
Net weight	4.05 kg
Box dimensions (w x d x h)	35 x 45 x 40 cm
Gross weight	5.50 kg

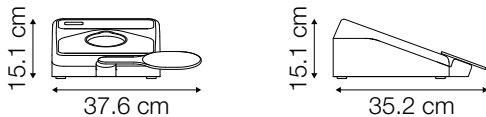

Scan® 50 pro - Ref. 435 055	
Net weight	4.45 kg
Box dimensions (w x d x h)	35 x 45 x 40 cm
Gross weight	6.15 kg

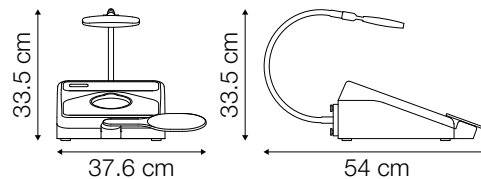

Scan® 50 pro + Magnifying lens - Ref. 435 055 + Ref. 435 001	
Net weight	5.13 kg
Box dimensions (w x d x h)	35 x 45 x 40 cm
Gross weight	6.83 kg



Colony counters and inhibition zone readers

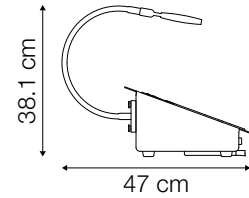
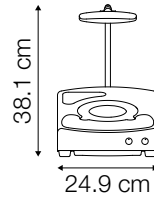
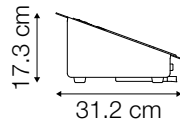
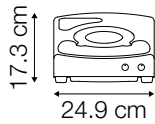

Scan® 100 - Ref. 435 000

Net weight	4.57 kg
Box dimensions (w x d x h)	50 x 40 x 40 cm
Gross weight	7.85 kg

Scan® 100 + Magnifying lens - Ref. 435 055 + Ref. 435 001

Net weight	5.14 kg
Box dimensions (w x d x h)	50 x 40 x 40 cm
Gross weight	8.40 kg

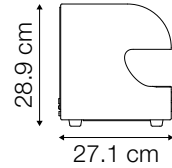
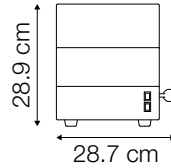
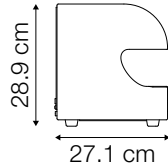
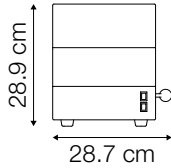

Scan® 300 - Ref. 436 300

Net weight	8.42 kg
Box dimensions (w x d x h)	50 x 40 x 40 cm
Gross weight	12 kg

Scan® 500 - Ref. 436 000

Net weight	8.38 kg
Box dimensions (w x d x h)	50 x 40 x 40 cm
Gross weight	12 kg

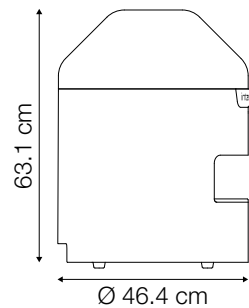
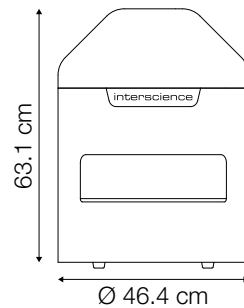
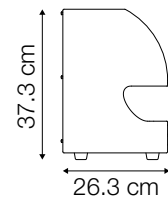
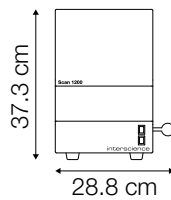

Scan® 1200 - Ref. 437 000

Net weight	9.40 kg
Box dimensions (w x d x h)	57 x 42 x 42 cm
Gross weight	13.10 kg

Scan® 4000 - Ref. 438 000









Net weight	25.15 kg
Box dimensions (w x d x h)	80 x 60 x 63 cm
Gross weight	32.50 kg

Product compatibility

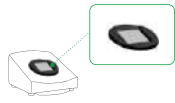

Product	Model	Scan®						
		50	50 pro	100	300	500	1200	4000
AUTOMATIC PLATERS								
easySpiral®	-	•	•	•	•	•	•	•
easySpiral® Pro	-	•	•	•	•	•	•	•
easySpiral® Pro Milk	-	•	•	•	•	•	•	•
easySpiral® Dilute	-	•	•	•	•	•	•	•
LAB ACCESSORIES								
PetriPile®	55	•	•	•			•	•
	65	•	•	•			•	•
	90	•	•	•	•	•	•	•
	150	•	•	•				•

Accessories





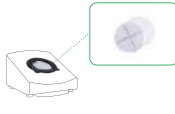

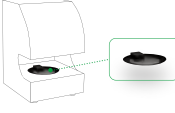
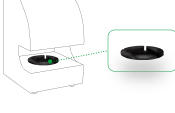
	Ref.	Designation	Description	Qty	Box		Scan® 50	Scan® 50 pro	Scan® 100	Scan® 300	Scan® 500	Scan® 1200	Scan® 4000
					Dimensions (cm)	Gross weight (kg)							
						410 100							
	410 120	Stickers for printer	2 rolls of 2500 labels for thermal printer - Label size: 45 x 10 mm	2 x 2500	18x25	0.47				•	•	•	•
	410 130	Film for printer	Thermal transfer film	1	12x10x8	0.08				•	•	•	•
	435 001	Magnifying lens	Magnifying lens + 1 flexible arm for Scan® 50, Scan® 50 pro and Scan® 100	1	25x19x5.5	0.68	•	•	•				
	435 002	Adaptor for Petrifilm™/MC-Media Pads™/Compact Dry™	Adaptor for Petrifilm™, MC-media Pads™, Compact Dry™ for Scan® 100	2	16.5x16x6.5	0.15			•				
	435 010	Spiral® DS counting grids	Spiral® DS counting grids: 1 transparent & 1 white diffusing background - Ø 90 mm / Ø 150 mm - For Scan® 100	2	16.5x16x6.5	0.09			•				
	435 020	Wolffhuegel™ counting grids	Wolffhuegel™ transparent and white counting grids for Scan® 100	2	16.5x16x6.6	0.10			•				
	435 025	Wolffhuegel™ counting grids	Wolffhuegel™ transparent and white counting grids for Scan® 50 and Scan® 50 pro.	2	12x10x8	0.1	•	•					
	435 030	Spiral® counting grids (90 mm)	easySpiral® counting grids: 1 transparent and 1 white diffusing background for Scan® 100 - Ø 90 mm	2	16.5x16x6.7	0.10			•				

Colony counters and inhibition zone readers

	Ref.	Designation	Description	Qty	Box									
					Dimensions (cm)	Scan® 50	Scan® 50 pro	Scan® 100	Scan® 300	Scan® 500	Scan® 1200	Scan® 4000		
													Gross weight (kg)	
	435 035	Spiral® counting grids (150 mm)	easySpiral® counting grids: 1 transparent and 1 white diffusing background for Scan® 100 - Ø 150 mm	2	16.5x16x6.8			•						
					0.10									
	435 036	Spiral® counting grids (90 mm)	easySpiral counting grids: 1 transparent and 1 white diffusing background for Scan® 50 and Scan® 50 pro - Ø 90 mm	2	12x10x8	•	•							
					0.1									
	435 037	Circle counting grids	easySpiral Dilute® circle counting grids: Ø 90 mm / Ø 150 mm - 1 transparent and 1 white diffusing background for Scan® 100	2	15 x 25 cm			•						
					0.09									
	435 038	Circle counting grids (90 mm)	easySpiral Dilute® circle counting grids: Ø 90 mm - 1 transparent and 1 white diffusing background for Scan® 50 and Scan® 50 pro	2	12x10x8	•	•							
					0.1									
	435 051	Adaptor for Petrifilm™/MC-Media Pads™/Compact Dry™	Adaptor for Petrifilm™, MC-media Pads™, Compact Dry™ for Scan® 50 and Scan® 50 pro	1	16.5x16x6.5	•	•							
					0.175									
	435 052	Headphones	Headphones for Scan® 50 and Scan® 50 pro. Connection with a jack socket.	1	13.5x4.5x18	•	•							
					0.35									
	435 702	Optical cleaner + wipes	Optical cleaner and wipes	1	25x19x5	•	•	•						•
					0.32									
	436 005	Adaptor for Petri dish (55 mm)	Adaptor for Petri dishes of Ø 55 mm for Scan® 300/500/1200	1	25x15x10				•	•	•			
					0.04									
	437 001	Adaptor for MC-Media Pads™	Adaptor for MC-Media Pads™ for Scan® 1200	1	25x15x10								•	
					0.11									
	437 002	Adaptor for Petrifilm™	Adaptor for Petrifilm™ for Scan® 1200	1	25x15x10								•	
					0.10									

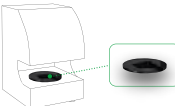

Colony counters and inhibition zone readers

	Ref.	Designation	Description	Qty	Box														
					Dimensions (cm)	Scan® 50	Scan® 50 pro	Scan® 100	Scan® 300	Scan® 500	Scan® 1200	Scan® 4000							
													Gross weight (kg)						
	437 003	Adaptor for Easy Plate™	Adaptor for Easy Plate™ for Scan® 1200	1	14x15x2														
					0.1														
	437 004	Adaptor for Compact Dry™	Adaptor for Compact Dry™ for Scan® 1200	1	25x15x10														
					0.15														
	439 050	dataLink™ pro	Traceability system with semi-automated labeling. The pack contains 1 printer, 1 power cord, 1 USB cable, 2 user's manuals, 1 thermal transfer film (ref. 439 052), 1 core, 3 rolls of 2500 adhesive labels (ref. 439 051), 1 USB key with the monitoring software	1	71x36x41.5														
					16														
	439 051	Stickers for printer (dataLink™ pro)	Set of 3 Labels roll for dataLink™ pro printer - Label size: 5x50mm - Qty: 3x2500	3x2500	25.7x21.5 x10.5														
					0,60														
	439 052	Film for printer (dataLink™ pro)	Thermal transfer film for dataLink™ pro printer	1	12.88x11.5 x8.5														
					0.22														
	522 000	Bar-code reader	Bar-code reader (1D/2D)	1	26x16.5x11														
					0.66														



Real-time incubators and
colony counters



Real-time incubators and colony counters

The real-time revolution!

ScanStation® is a real-time colony counting and incubation station. It centralizes incubation, detection and counting of colonies on up to 300 Petri dishes simultaneously.



Top features of the range

A revolution in microbiology

Colony counting is performed during incubation. A video of the bacterial growth is available in real time.

PATENTED

Efficient results

The results are available in 8 hours instead of 24 hours. **ScanStation®** can process up to 300 Petri dishes simultaneously.

Traceability

The data is accessible during incubation until the final validation of the results. It is then archived. **ScanStation®** is compatible with all LIMS.



Mono or multi-batch

Petri dishes can be loaded at the beginning or during incubation.

dataLink®

ScanStation® is compatible with **dataLink®** traceability system. All data is automatically transmitted and traceable.

Data integrity

ScanStation® saves images and videos of microbial growth. The software complies with 21 CFR part 11 guidelines.



Range overview



ScanStation® 100	ScanStation® 200	ScanStation® 300
Real-time incubator and colony counter		
100 Petri dishes	200 Petri dishes	300 Petri dishes

	Top features		
Reading interval between each dish	30 min or 1h	30 min or 1h	1h
Mono or multi-batch loading	✓	✓	✓
Data integrity	✓	✓	✓
Compatibility with dataLink® pro	✓	✓	✓
Telecentric lens	-	-	✓
Accurate counting on the edges of the dish	-	-	✓

ScanStation® 100

Real-time incubator and colony counter

100 Petri dishes

Ref. 439 100



Real-time incubators and colony counters

ScanStation® 100 performs incubation, detection and counting on Petri dishes. Colonies are detected and counted as soon as they appear. Their growth is monitored in real time. **ScanStation® 100** can accommodate up to 100 Petri dishes.



DIGITALIZE AND SECURE YOUR DATA

21 CFR Part 11 module

Ref. 800 700

[For more information, please refer to page 136](#)



Food



Environmental



Pharmaceutical



Cosmetics



Veterinary



Public research

MAIN FEATURES

- Capacity: up to 100 Petri dishes
- Counting on pour plate, surface, Spiral®, filtration membranes
- Petri dish sizes: Ø 55 to 65 mm, Ø 90 mm
- Accuracy of incubation temperature: $\pm 1^{\circ}\text{C}$
- Reading time between Petri dishes: 30 min or 1 h

APPLICATIONS

ScanStation® automatic incubator and colony counter can be integrated into a wide range of applications. It is particularly used for environmental and bioburden control in pharmaceutical production. Its microbial kinetics provide real-time results and allow an early corrective action when contamination is detected. It can be adapted to different dish formats such as contact dishes for the detection of *Candida* or samples from a biocollector for the detection of *Aspergillus*.



ScanStation® 200

Real-time incubator and colony counter

200 Petri dishes

Ref. 439 200



ScanStation® 200 performs incubation, detection and counting on Petri dishes. Colonies are detected and counted as soon as they appear. Their growth is monitored in real time. **ScanStation® 200** can accommodate up to 200 Petri dishes.



Food



Environmental



Pharmaceutical



Cosmetics



Veterinary



Public research



AUTONOMOUS BIO-DECONTAMINATION

Nebulizer for real-time incubator and colony counter

Ref. 439 060

[For more information, please refer to page 135](#)

MAIN FEATURES

- **Capacity:** up to 200 Petri dishes
- **Counting on pour plate, surface, Spiral®, filtration membranes**
- **Petri dish sizes:** Ø 55 to 65 mm, Ø 90 mm
- **Accuracy of incubation temperature:** ± 1°C
- **Reading time between Petri dishes:** 30 min or 1 h

APPLICATIONS

ScanStation® automatic incubator and colony counter can be integrated into a wide range of applications. Its microbial kinetics improve counting accuracy by eliminating false positives linked to particles present in a cosmetic product. It is particularly used for quality control of raw materials and/or cosmetics production. Its bacterial kinetics provide real-time results and allow an early corrective action when contamination is detected for an improved stock management.



ScanStation® 300



Real-time incubator and colony counter

300 Petri dishes

Ref. 439 300

Real-time incubators and colony counters

ScanStation® 300 performs incubation, detection and counting on Petri dishes. Colonies are detected and counted as soon as they appear. Their growth is monitored in real time. **ScanStation® 300** can accommodate up to 300 Petri dishes.



TRACEABILITY SYSTEM

dataLink® pro
Ref. 439 050

[For more information, please refer to page 135](#)



Food



Environmental



Pharmaceutical



Cosmetics



Veterinary



Public research

MAIN FEATURES

- Capacity: up to 300 Petri dishes
- Counting on pour plate, surface, Spiral®, filtration membranes
- Petri dish sizes: Ø 55 to 65 mm, Ø 90 mm
- Telecentric lens: improves the counting around Petri dish edges
- Reading time between Petri dishes: 1 hour

APPLICATIONS

ScanStation® automatic incubator and colony counter can be integrated into a wide range of applications. Its microbial kinetics provide real-time and anticipated results for the detection of pathogens, such as *Listeria monocytogenes*, *Salmonella* spp. or *Campylobacter* spp. It is particularly used for the Quality Control of ultra-fresh finished products with a short shelf life allowing an improved stock management.



Technical specifications of the range

	ScanStation®		
	100	200	300
OVERVIEW			
Reference	439 100	439 200	439 300
Electronic locking door	✓	✓	✓
Pressure sensitive gripper to fit any type of Petri dish	✓	✓	✓
Internal light: white LEDs	✓	✓	✓
First carousel petal block removable	✓	✓	✓
Compatible with dataLink® pro traceability system	✓	✓	✓
Telecentric lens	-	-	✓
Accurate counting around the edges of Petri dish	-	-	✓
SPECIFICATIONS			
Capacity	100 Petri dishes	200 Petri dishes	300 Petri dishes
Reading time in between Petri dishes	30 minutes or 1 hour		1 hour
Petri dish size	Ø 90 mm right-side up or upside down and Ø 55-65 mm (with adaptor)		
Type of plating accepted	Pour plate, surface, Spiral® and filtration membrane		
Loading	Single or multi-batch		
Camera resolution	5 megapixels		
Interface	23 inch touch screen		
Software	ScanStation® software		
Languages	English, French, Japanese, Chinese, Spanish, German		
Video player	Play, zoom, pause, replay, during and after incubation		
Included computer system	PC Windows 10 LTSC desktop with Intel i7 processor		
Incubation temperature	20 °C to 45 °C (68 °F to 113 °F)		
Accuracy of incubation temperature	± 1 °C (checked by a 9-point mapping system)		
Recording temperature	Every minute		
Heating and cooling technology	Peltier modules, compressor free		
Storage conditions	In a ventilated room, between 18 °C and 25 °C (64.4 °F and 77 °F)		
Max. external humidity temperature	70%		
Max. incubation time	10 days		
Voltage - frequency	100-240 V~ 50-60 Hz		
Warranty	1 year		
Software updates	3 years (after recording the warranty card)		
Spare parts availability	10 years		
In compliance with	21 CFR Part 11		
Manufactured under	CE, UKCA, RoHS, WEEE, FCC, NRTL North America		
DATA TRACEABILITY			
Export formats	mp4 video, pdf report, jpeg, png or bmp images, csv or xls text		
Data transfer via USB link	LIMS, dataLink®		

DELIVERED WITH

1 computer and its power cable, 1 Wi-Fi antenna connected to the computer, 1 monitor with its power cable, 1 Display Port cable, 1 USB 3 cable, 1 wireless keyboard, 1 wireless mouse, 1 dongle for keyboard and wireless mouse, 1 mains power cable, 1 temperature map, 1 user manual, 1 maintenance kit including 1 optical cleaner bottle and 1 grease pump, 1 test pattern, 1 conformity certificate / warranty card.



WEIGHT AND DIMENSIONS

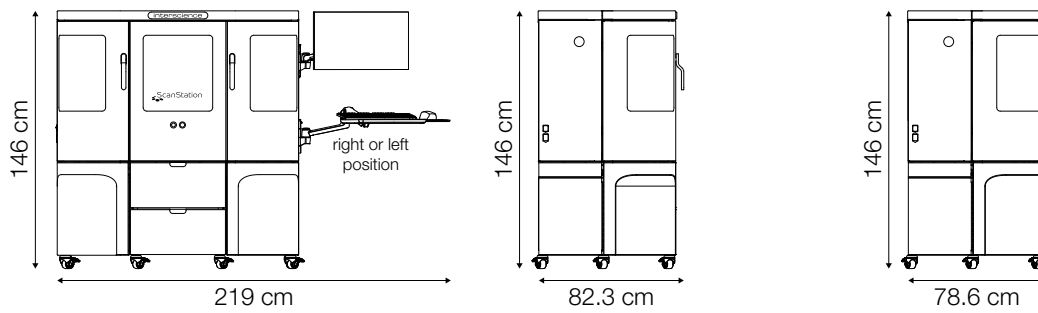

ScanStation® 100 + Storage furniture + Lateral supports for screen and keyboard
Ref. 439 100 + Ref. 439 120 + Ref. 439 110

Net weight	347 kg
Box (w x d x h)	168.6 x 96 x 226 cm
Gross weight	517 kg

ScanStation® 100 (no option)
with handles unmounted
+ Storage furniture
Ref. 439 100 + Ref. 439 120

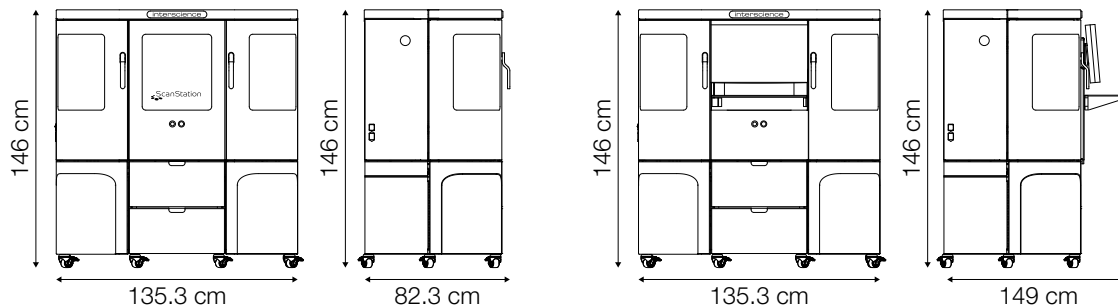

ScanStation® 100 (no option) + Storage furniture
Ref. 439 100 + Ref. 439 120

Net weight	340 kg
Box (w x d x h)	168.6 x 96 x 226 cm
Gross weight	510 kg

ScanStation® 100 + Storage furniture + Central supports for screen and keyboard - Ref. 439 100 + Ref. 439 120 + Ref. 439 111

Net weight	345.8 kg
Box (w x d x h)	168.6 x 96 x 226 cm
Gross weight	515.80 kg

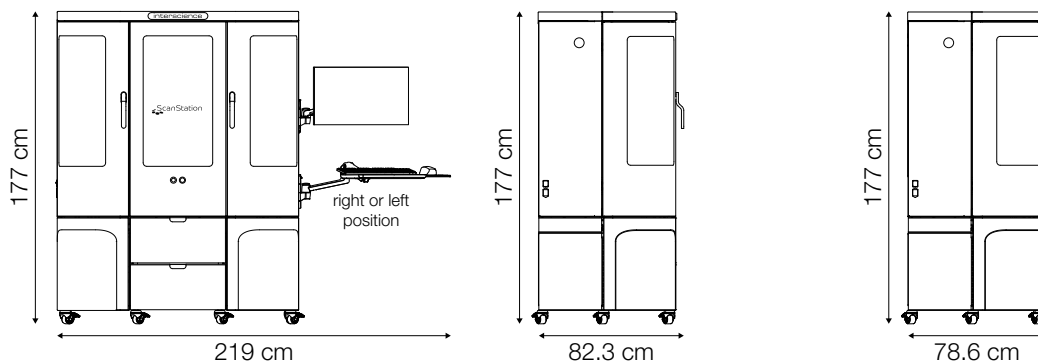

ScanStation® 200 + Storage furniture + Lateral supports for screen and keyboard
Ref. 439 200 + Ref. 439 120 + Ref. 439 110

Net weight	390 kg
Box (w x d x h)	168.6 x 96 x 226 cm
Gross weight	560 kg

ScanStation® 200 (no option)
with handles unmounted
+ Storage furniture
Ref. 439 200 + Ref. 439 120



Real-time incubators and colony counters

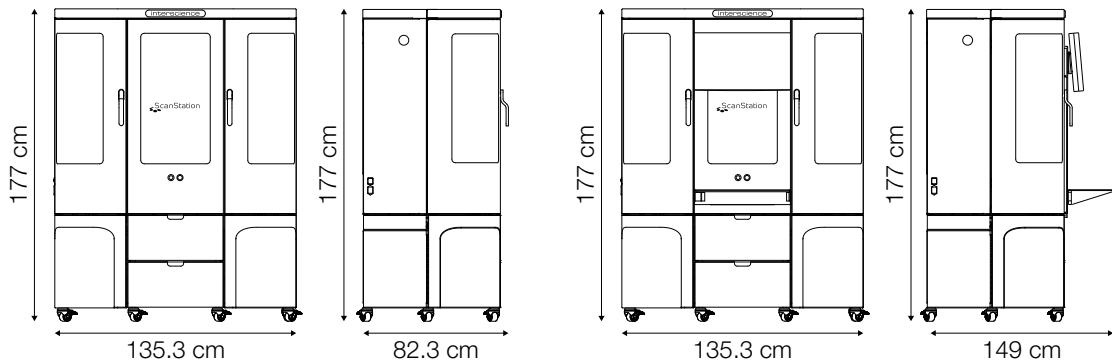

ScanStation® 200 (no option) + Storage furniture Ref. 439 200 + Ref. 439 120	
Net weight	383 kg
Box (w x d x h)	168.6 x 96 x 226 cm
Gross weight	553 kg

ScanStation® 200 + Storage furniture + Central supports for screen and keyboard - Ref. 439 200 + Ref. 439 120 + Ref. 439 111	
Net weight	388.80 kg
Box (w x d x h)	168.6 x 96 x 226 cm
Gross weight	558.80 kg

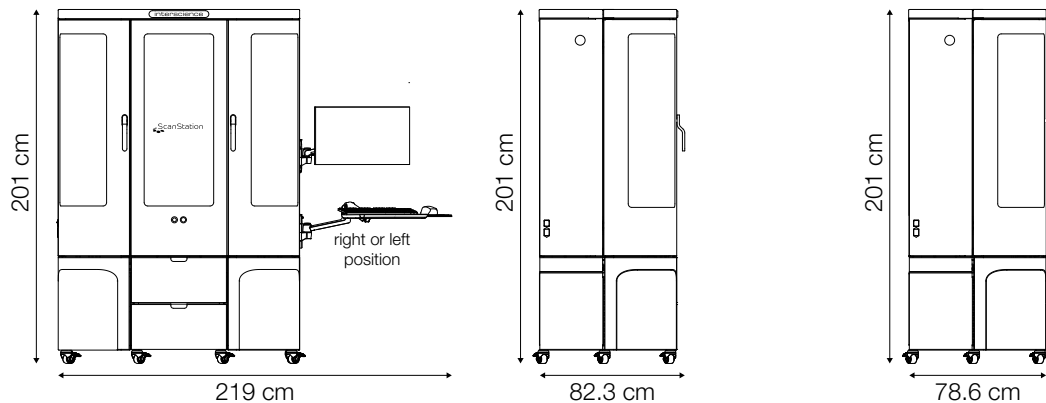

ScanStation® 300 + Storage furniture + Lateral supports for screen and keyboard Ref. 439 300 + Ref. 439 120 + Ref. 439 110	
Net weight	427 kg
Box (w x d x h)	168.6 x 96 x 226 cm
Gross weight	597 kg

ScanStation® 300 (no option) with handles unmounted
+ Storage furniture
Ref. 439 300 + Ref. 439 120

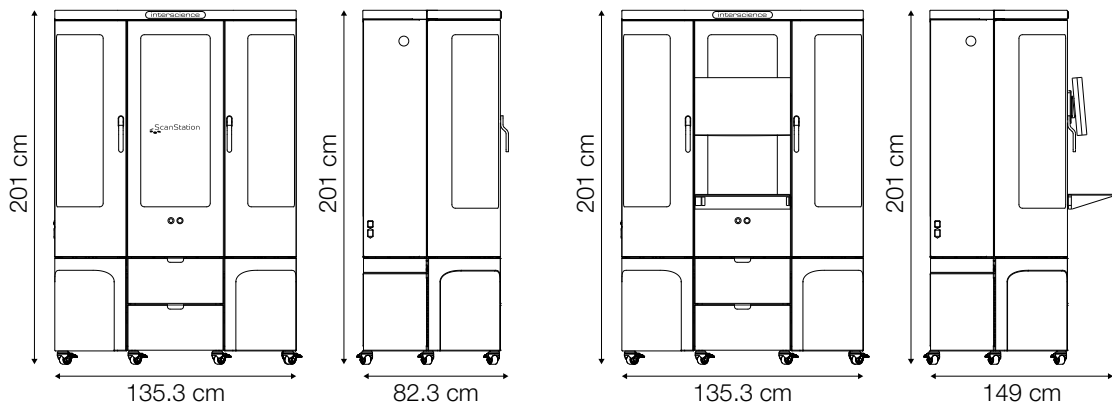

ScanStation® 300 (without option) + Storage furniture Ref. 439 300 + Ref. 439 120	
Net weight	420 kg
Box (w x d x h)	168.6 x 96 x 226 cm
Gross weight	590 kg

ScanStation® 300 + Storage furniture + Central supports for screen and keyboard - Ref. 439 300 + Ref. 439 120 + Ref. 439 111	
Net weight	425.80 kg
Box (w x d x h)	168.6 x 96 x 226 cm
Gross weight	595.80 kg

Product compatibility







Product	Model	ScanStation®		
		100	200	300
AUTOMATIC PLATERS				
easySpiral®	-	•	•	•
easySpiral® Pro	-	•	•	•
easySpiral® Pro Milk	-	•	•	•
easySpiral® Dilute	-	•	•	•
LAB ACCESSORIES				
PetriPile®	55	•	•	•
	65	•	•	•
	90	•	•	•
	150			

Real-time incubators and colony counters













Accessories

	Ref.	Designation	Description	Qty	Box			
					Dimensions (cm)	ScanStation® 100	ScanStation® 200	ScanStation® 300
	435 702	Optical cleaner + wipes	Optical cleaner and wipes	1	25x19x5	•	•	•
					0.32			
	439 021	Set of adaptors	Set of 15 adaptors for ScanStation®: for Petri dishes Ø 54mm, Ø 55mm, Ø 56mm, Ø 57mm, Ø 58 mm, Ø 59 mm, Ø 60 mm, Ø 61 mm, Ø 62 mm, Ø 63 mm, Ø 64 mm, Ø 65 mm, Ø 66 mm, for contact plate: Ø 65 mm, Ø 67 mm	7	12x10x8	•	•	•
					0.20			
	439 022	Adaptor for Petri dishes (Ø 54 mm)	Set of 10 adaptors for Ø 54 mm Petri dishes for ScanStation®	10	12x10x8	•	•	•
					0.20			
	439 023	Adaptor for Petri dishes (Ø 55 mm)	Set of 10 adaptors for Ø 55 mm Petri dishes for ScanStation®	10	12x10x8	•	•	•
					0.20			
	439 024	Adaptor for Petri dishes (Ø 56 mm)	Set of 10 adaptors for Ø 56 mm Petri dishes for ScanStation®	10	12x10x8	•	•	•
					0.20			
	439 025	Adaptor for Petri dishes (Ø 57 mm)	Set of 10 adaptors for Ø 57 mm Petri dishes for ScanStation®	10	12x10x8	•	•	•
					0.20			
	439 026	Adaptor for Petri dishes (Ø 58 mm)	Set of 10 adaptors for Ø 58 mm Petri dishes for ScanStation®	10	12x10x8	•	•	•
					0.20			
	439 027	Adaptor for Petri dishes (Ø 59 mm)	Set of 10 adaptors for Ø 59 mm Petri dishes for ScanStation®	10	12x10x8	•	•	•
					0.15			
	439 028	Adaptor for Petri dishes (Ø 60 mm)	Set of 10 adaptors for Ø 60 mm Petri dishes for ScanStation®	10	12x10x8	•	•	•
					0.15			
	439 029	Adaptor for Petri dishes (Ø 61 mm)	Set of 10 adaptors for Ø 61 mm Petri dishes for ScanStation®	10	12x10x8	•	•	•
					0.15			



Real-time incubators and colony counters

	Ref.	Designation	Description	Qty	Box		ScanStation® 100	ScanStation® 200	ScanStation® 300
					Dimensions (cm)	Gross weight (kg)			
	439 030	Adaptor for Petri dishes (Ø 62 mm)	Set of 10 adaptors for Ø 62 mm Petri dishes for ScanStation®	10	12x10x8	0.15	•	•	•
	439 031	Adaptor for Petri dishes (Ø 63 mm)	Set of 10 adaptors for Ø 63 mm Petri dishes for ScanStation®	10	12x10x8	0.15	•	•	•
	439 032	Adaptor for Petri dishes (Ø 64 mm)	Set of 10 adaptors for Ø 64 mm Petri dishes for ScanStation®	10	12x10x8	0.15	•	•	•
	439 033	Adaptor for Petri dishes (Ø 65 mm)	Set of 10 adaptors for Ø 65 mm Petri dishes for ScanStation®	10	12x10x8	0.15	•	•	•
	439 034	Adaptor for Petri dishes (Ø 66 mm)	Set of 10 adaptors for Ø 66 mm Petri dishes for ScanStation®	10	12x10x8	0.20	•	•	•
	439 040	Adaptor for contact plate (Ø 65 mm)	Set of 10 adaptors for Ø 65 mm contact plates for ScanStation	10	12x10x8	0.20	•	•	•
	439 042	Adaptor for contact plate (Ø 67 mm)	Set of 10 adaptors for Ø 67 mm contact plates for ScanStation®	10	12x10x8	0.20	•	•	•
	439 050	dataLink® pro	Traceability system with semi-automated labeling. The pack contains 1 printer, 1 power cord, 1 USB cable, 2 user's manuals, 1 thermal transfer film (ref. 439 052), 1 core, 3 rolls of 2500 adhesive labels (ref. 439 051), 1 USB key with the monitoring software	1	71x36x41.5	16	•	•	•
	439 051	Stickers for printer (dataLink® pro)	Set of 3 Labels roll for dataLink® pro printer - Label size: 5x50mm - Qty: 3x2500	3x2500	25.7x21.5x10.5	0.6	•	•	•
	439 052	Film for printer (dataLink® pro)	Thermal transfer film for dataLink® pro printer	1	12.88x11.5x8.5	0.22	•	•	•
	439 060	Nebulizer for real-time incubator and colony counter	Disinfection unit for ScanStation® (Phileas Genius™)	1	41x36x32	8.40	•	•	•



Real-time incubators and colony counters

	Ref.	Designation	Description	Qty	Box			ScanStation® 100	ScanStation® 200	ScanStation® 300
					Dimensions (cm)		Gross weight (kg)			
	439 061	Stand for nebulizer	Support for Phileas Genius™ disinfection unit	1	31x25.1x10	0.70	•	•	•	
	439 062	Disinfectant for nebulizer	O2SAFE 7.4 disinfectant for Phileas Genius™ disinfection unit. 10L	1	30x20x20	10.0	•	•	•	
	439 110	Lateral stands for screen and keyboard	1 keyboard shelf support + 1 screen support on articulated arms for ScanStation®. They allow the height and orientation of the keyboard and screen to be adjusted. Position: right or left side of the ScanStation®	1	52x29x38	8.00	•	•	•	
	439 111	Central stands for screen and keyboard	1 keyboard shelf support + 1 screen support for ScanStation®. They allow the height of the keyboard and screen to be adjusted. Position: front side of the ScanStation®	1	55x35x20	5.80	•	•	•	
	439 120	Storage furniture for real-time incubator and colony counter	ScanStation® furniture for PC and accessories storage	1	135x80x62	70.0	•	•	•	
	439 140	Uninterrupted power supply (220 V)	Protection in case of power failure (220V) for ScanStation®	1	75x59x19	35.0	•	•	•	
	439 145	Uninterrupted power supply (110 V)	Protection in case of power failure (110V) for ScanStation®	1	75x59x34	50.0	•	•	•	
	439 170	Module for Petri dish automatic identification	Bar-code reader (1D) and datamatrix (2D) for automatic identification of the Petri dishes for ScanStation®	1	25x15x10	0.75	•	•	•	
	439 190	Maintenance kit for real-time incubator and colony counter	Maintenance kit for ScanStation® with: 1 grease pump, 1 grease, 1 brush, 1 Torx T10 wrench, 1 Torx T20 Wrench, 1 hexagon key hexagonal 2.5mm, 4 fan filters, 1 optical cleaner, 50 cleaning wipes, 4 "Biohazards" labels	1	25x20x10	0.76	•	•	•	
	439 192	Test pattern for real-time incubator and colony counter	Test pattern for ScanStation® 100/200/300	1	13x11.5x8.5	0.08	•	•	•	
	800 700	21 CFR Part 11 module	21CFR part 11 module for audit trail, validation of results and management of the software for ScanStation®	1	-	-	•	•	•	



Blender bags with filter

Blender bags with filter

Skip the time-consuming sample preparation

INTERSCIENCE is the only manufacturer to produce in the same factory the whole Sample Prep: bags, dilutors and lab blenders. Our expertise is recognized for this key step of the analysis. The filter bags allow the filtrate to be diluted, blended and pipetted in a single-use bag. Filtration is instantaneous and without risk of cross-contamination.



Why use a filter bag?

Filter bags are smart bags where the sample is filtrated, collected, diluted and pipetted in a single bag. Filtration is instantaneous and without risk of cross-contamination.

Standard bag
No filtration



Filter bag
Instant filtration

Sample preparation

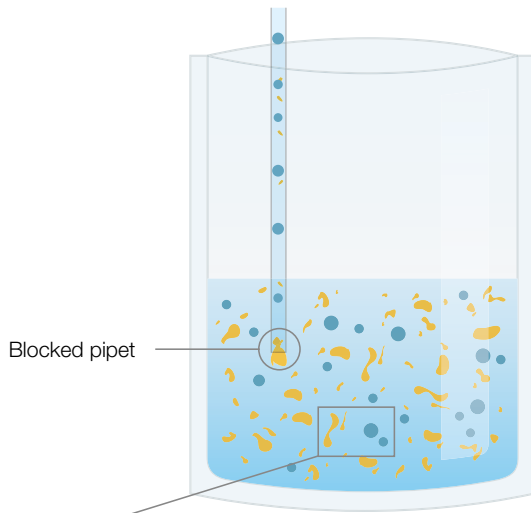

Blocked pipet

Sample mixed with microorganisms

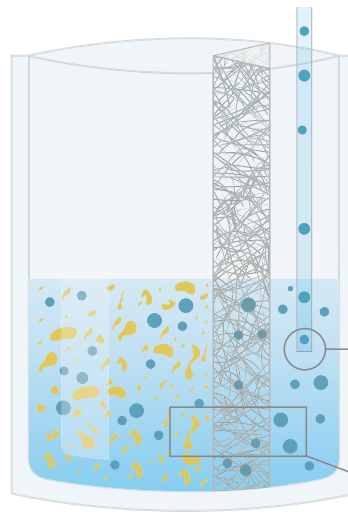

Easy pipetting

Microorganisms and sample are filtered and clearly separated

Plating and incubation

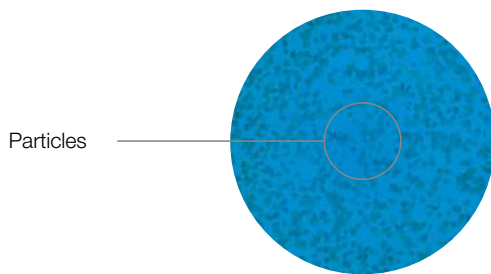

Particles

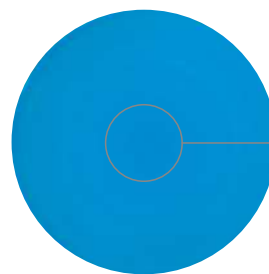

No particles

Results

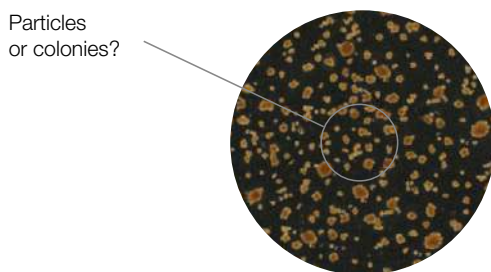

Particles or colonies?

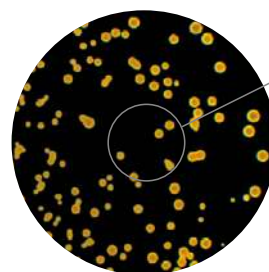

Colonies only

Time-consuming with non-accurate results

Optimized manipulation with accurate results



Top features of the range

Instant filtration

Filtration is performed during blending. The filtrate is particle-free and therefore reduces false positives at the final reading.

Quick sticker closure⁽¹⁾

Without any extra tools, simply close with the built-in closure sticker.

PATENTED

All in one

Sampling, weighing, dilution, bacterial extraction, filtration and pipetting in one bag.



Easy pipetting access⁽¹⁾

The pipetting area reduces the action of opening/closing the bag.

PATENTED

High quality manufacturing

Elimination of the bags' electrostatic electricity for neat work.

No cross-contaminations

There is no contact between the sample and the mixer during homogenization.

(1) Valid according to the model, refer to the technical specifications.



Range overview

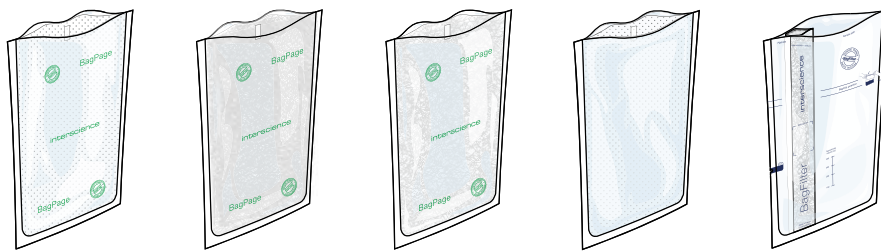

BEST-SELLER				BEST-SELLER
BagPage® +	BagPage® F	BagPage® R	BagPage® XR	BagFilter® P
Full-page filter bag	Full-page filter bag	Full-page filter bag	Full-page filter bag	Lateral filter bag
Microperforated filter	For PCR, flow cytometry	Non-woven filter	Extra-Resistant	For pipetting

	Top features				
Type of bag	Full-page filter bag	Full-page filter bag	Full-page filter bag	Full-page filter bag	Lateral filter bag
Filter porosity	280 µm	< 60 µm	< 250 µm	280 µm	< 250 µm
Made in France	✓	✓	✓	✓	✓
Available in 100 mL	✓	-	-	-	-
Available in 400 mL	✓	✓	✓	✓	✓
Available in 2000 and 3500 mL	✓	-	-	-	✓
Extra-resistant bag	-	-	-	✓	-
Marking zone and volume indicator	-	-	-	-	✓
Precut for pipetting	-	-	-	-	✓
Easy pipetting access sticker	-	-	-	-	-
Built-in closure sticker	-	-	-	-	-

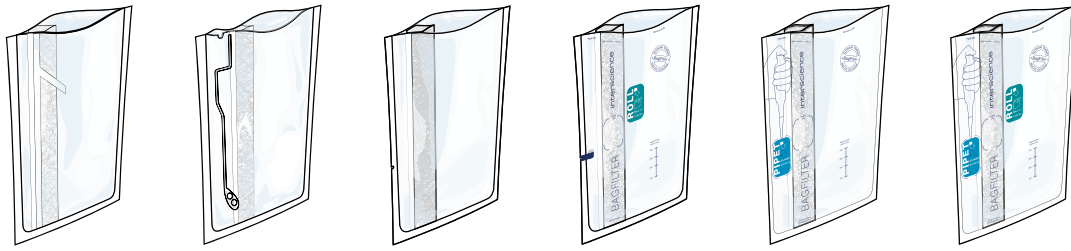

BagFilter® S	BagFilter® Pull-Up®	BagFilter® XF	BagFilter® Roll	BagFilter® Pipet	BagFilter® Pipet & Roll
Lateral filter bag	Lateral filter bag	Lateral filter bag	Lateral filter bag with built-in closure	Lateral filter bag with easy pipet access	Lateral filter bag with pipet access and built-in closure
For pouring	For PCR and small volumes	For PCR, extra-fine filtration	Quick closure	Easy pipetting	Easy pipetting and quick closure

Top features					
Lateral filter bag	Lateral filter bag	Lateral filter bag	Lateral filter bag	Lateral filter bag	Lateral filter bag
< 250 µm	< 50 µm	< 20 µm	< 250 µm	< 250 µm	< 250 µm
✓	✓	✓	✓	✓	✓
-	-	-	-	-	-
✓	✓	✓	✓	✓	✓
-	-	-	-	-	-
-	-	-	-	-	-
-	-	-	✓	✓	✓
-	-	-	✓	-	-
-	-	-	-	✓	✓
-	-	-	✓	-	✓



BEST-SELLER

BagPage® +

Full-page filter bag

Microperforated filter

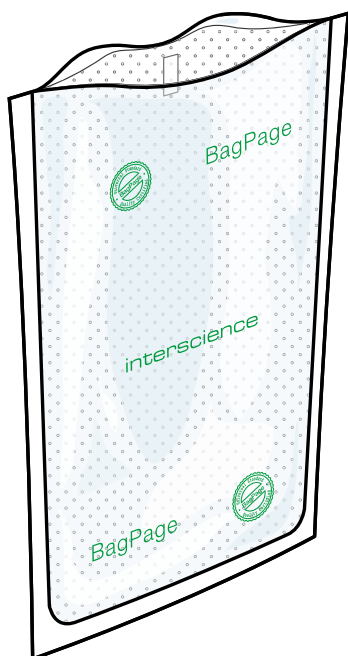

- Ref. 121 025 (100 mL)
- Ref. 122 025 (400 mL)
- Ref. 122 200 (2000 mL)
- Ref. 123 010 (3500 mL)

BagPage® + is a blender bag with a full-screen microperforated filter. Filtration is instantaneous without risks of cross contaminations. A unique welding system on the bag allows pipetting without error.



Food



Environmental



Pharmaceutical



Cosmetics



Veterinary



Public research



PIPET VERTICALLY

BagOpen® - Bag opener/holder

- Ref. 211 010 (80/100 mL)
- Ref. 211 040 (400 mL - 2000 mL)
- Ref. 211 350 (3500 mL)

For more information, please refer to page 81

MAIN FEATURES

- **Filter porosity: 280 micrometers**
- **Compatible with any laboratory blender**
- **Multilayer®: reinforced multicoated complex**
- **Rigid and transparent**

APPLICATIONS

BagPage® + adapts itself to every stage of sample preparation. Depending on the protocols, it is used in the food, pharmaceutical, cosmetic, environmental, animal health and public research institutes:

- **BagPage® + 100 mL:** allows the preparation of small samples (1 to 10 g) in the pharmaceutical industries, cosmetics or animal health (Biopsy preparation).
- **BagPage® + 400 mL:** is suitable for samples of 25 g in the food industry.
- **BagPage® + 2000 mL:** sample preparation up to 1500 mL with a 100/150 g sample size. Ideal for *Salmonella* spp. detection via PCR method.
- **BagPage® + 3500 mL:** sample size up to 375 g for pooling samples in the food industry.

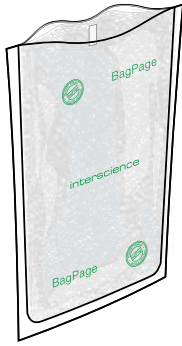

Ref. 122 325 (400 mL)

BagPage® F

Full-page filter bag
For PCR, flow cytometry

MAIN FEATURES

- Filter porosity: < 60 micrometers
- Multilayer: reinforced multicoated complex

APPLICATIONS

BagPage® F is useful according to protocols in microbiological analyses in the food, pharmaceutical, cosmetic, environmental and public research institutes. It is suitable for analyses such as flow cytometry and PCR.

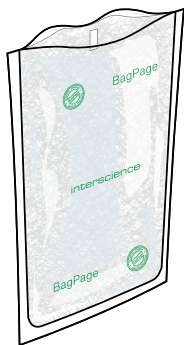

Ref. 161 025 (400 mL)

BagPage® R

Full-page filter bag
Non-woven filter

MAIN FEATURES

- Filter porosity: < 250 micrometers
- Multilayer: reinforced multicoated complex

APPLICATIONS

BagPage® R is useful according to protocols in microbiological analyses in the food, pharmaceutical, cosmetic, environmental, veterinary and public research institutes. It is used for the preparation of samples that could clog the filter.

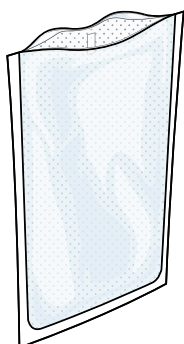

Ref. 122 425 (400 mL)

BagPage® XR

Full-page filter bag
Extra-Resistant

MAIN FEATURES

- Filter porosity: 280 micrometers
- Extra resistant material: 50% thicker

APPLICATIONS

BagPage® XR is useful according to protocols in microbiological analyses in the food, pharmaceutical, cosmetic, environmental, veterinary and public research institutes. Extra strong, it is used for the preparation of samples that can pierce bags (seafood, medical devices, etc.).



Blender bags with filter



Food



Environmental



Pharmaceutical



Cosmetics



Public research



BEST-SELLER

BagFilter® P

Lateral filter bag

Ideal for pipetting

- Ref. 111 425 (400 mL)
- Ref. 111 200 (2000 mL)
- Ref. 113 510 (3500 mL)

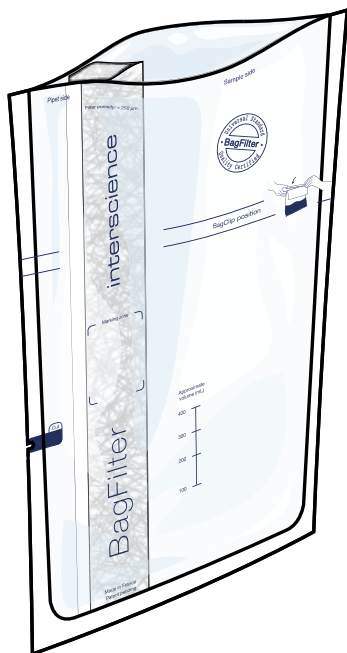

BagFilter® P is a bag with a non-woven side filter. Filtration is instantaneous without the risk of cross-contamination. It is ideal for pipetting.



Food



Environmental



Pharmaceutical



Cosmetics



Veterinary



Public research



SAMPLE FROM THE CORE OF THE SAMPLE

BagPipet® - Fixed-volume pipet
Ref. 251 091

[For more information, please refer to page 78](#)

MAIN FEATURES

- Porosity of the filter: < 250 micrometers
- Compatible with any laboratory blender
- Multilayer: reinforced multicoated complex
- Rigid and transparent
- Marking closing zone - **PATENTED**

APPLICATIONS

BagFilter® P adapts itself to every stage of sample preparation. Depending on the protocols, it is used in the food, pharmaceutical, cosmetic, environmental, animal health and public institutes:

- **BagFilter® P** 400 mL is adapted for the analysis of hygiene criteria including the 25 g test sample diluted to 1/10th. The filter inside the bag enables seeding a filtrate without particles.
- **BagFilter® P** 2000 mL is ideal for the search for *Salmonella* via the PCR method, for example. It is also used for sample preparation up to 1500 mL with a test portion of 100 / 150 g.
- **BagFilter® P** 3500 mL is specifically used in the food industry for sample pooling with a sample size up to 375 g.

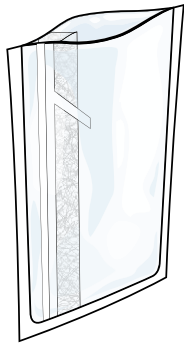

Ref. 112 425 (400 mL)

BagFilter® S

Lateral filter bag

Ideal for pouring

MAIN FEATURES

- Porosity of the filter: < 250 micrometers
- Multilayer: reinforced multicoated complex

APPLICATIONS

BagFilter® S is used according to protocols in the food, pharmaceutical, cosmetic, environmental and public research institutes. It allows the pouring of the filtrate without particles for further analysis.

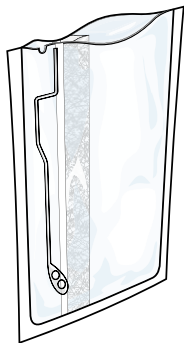

Ref. 111 625 (400 mL)

BagFilter® Pull-Up®

Lateral filter bag

For PCR, small volumes

MAIN FEATURES

- For PCR and small volumes: < 1000 µL
- Filter porosity < 50 micrometers
- Patented design

APPLICATIONS

BagFilter® Pull-Up® is used according to the protocols in food, pharmaceutical, cosmetic, environmental and public research institutes. It is suitable for flow cytometry and PCR protocols thanks to its pipetting area adapted to micropipettes.

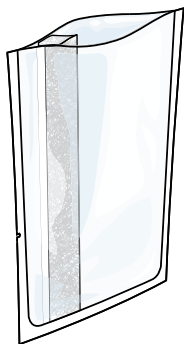

Ref. 111 325 (400 mL)

BagFilter® XF

Lateral filter bag

For PCR, extra-fine filtration

MAIN FEATURES

- Filter porosity: < 20 micrometers
- Multilayer: reinforced multicoated complex

APPLICATIONS

BagFilter® XF is suited for capillary analysis systems such as flow cytometry and PCR. **BagFilter® XF** is ideal for samples with fine particles (spices, powders, dust...). It is also designed to separate the organic elements of the filtrate (fat, sugar, food gum, excipients...)



Blender bags with filter



Food



Environmental



Pharmaceutical



Cosmetics



Public research



BagFilter® Pipet & Roll

Lateral filter bag with pipet access and built-in closure

Easy pipetting and quick closure

Ref. 111 720 (400 mL)

BagFilter® Pipet & Roll is a bag with a non-woven side filter. The Pipet sticker allows successive pipetting. The Roll sticker ensures a tight closure of the bag. It is ideal for pre-enrichment of pathogens.



FACILITATE YOUR PATHOGEN TRANSPLANTS IN PSM

BagRack® Slide - Storage rack for bags
Ref. 221 440

For more information, please refer to [page 73](#)

MAIN FEATURES

- Easy pipetting access sticker
- Built-in closure sticker
- Optimal volume for blending: 50 - 300 mL
- Porosity of the non-woven filter: < 250 micrometers



Food



Environmental



Public research

APPLICATIONS

BagFilter® Pipet & Roll, with an integrated closing and pipetting sticker, optimizes the organization of pipetting. It secures the sampling for subculturing when searching for pathogens such as *Listeria monocytogenes* and *Salmonella* spp. The sticker on the top part allows the unique and tight closing of the bag and the pipetting sticker on the bottom part prevents cross-contamination.



BagFilter® Roll



Lateral filter bag
with built-in closure

Quick closure

MAIN FEATURES

- Built-in closure sticker
- Optimal blending volume: 50 - 300 mL
- Porosity of the non-woven filter: < 250 micrometers

Ref. 111 700 (400 mL)

APPLICATIONS

BagFilter® Roll is used for sampling in production of any kind of sample. This sampling allows the analysis of quality indicators in food industry or the detection of pathogens on raw materials in the pharmaceutical field. Its integrated filter allows the sample to be prepared in the same bag.

BagFilter® Pipet



Lateral filter bag
with easy pipet access

Easy pipetting

MAINS FEATURES

- Easy pipetting access
- Optimal volume for blending: 50 - 300 mL
- Porosity of the non-woven filter: < 250 micrometers

Ref. 111 710 (400 mL)

APPLICATIONS

BagFilter® Pipet optimizes the organization of pipetting. It secures the sample for the subculture when searching for pathogens such as *Listeria monocytogenes* and *Salmonella* spp. The pipetting sticker at the bottom of the bag prevents cross-contamination via the pipetting device.



Food



Environmental



Public research



Technical specifications of the range

	BagPage®						
	100	+ 400	+ 2000	+ 3500	F 400	R 400	XR 400
OVERVIEW							
Reference	121 025	122 025	122 200	123 010	122 325	161 025	122 425
Ideal	Pasty samples				Flow cytometry, PCR	Pasty samples	Very hard samples or long blending time
Built-in sticker for bag closure	-						
Reclosable sticker for easy pipetting with a micropipette cone	-						
Precut for pipetting	-						
Marking zone	-						
Volume indicator	-						
Closing zone (Patented)	-						
SPECIFICATIONS							
Type of bag	Bag with full-page filter						
Bag composition	Multilayer®: reinforced multicoated complex						
Type of filter	Microperforated				Non-woven		Microperforated
Filter porosity	280 µm				< 60 µm	< 250 µm	280 µm
Gamma ray treated	5 to 12 KGy, with certificate						
Shelf-life	10 years						
Temperature resistance	-40 °C to 80 °C (-40 °F to 176 °F)						
In compliance with	ISO 7218, ISO 6887 and FDA BAM (Bacteriological Analytical Manual)						
Approved for food contact	Regulation (EC) No 1935/2004						
Storage conditions	In a temperate and dry place, away from humidity and light						
VOLUMES							
Max blending volume	100 mL	400 mL	2000 mL	3750 mL	400 mL		
Optimal blending volume	5-50 mL	50-300 mL	400-1500 mL	400-3750 mL	50-300 mL		
Optimal volume for pipetting	-						



BagFilter®								
P 400	P 2000	P 3500	S 400	Pull-Up 400	XF 400	Roll 400	Pipet 400	Pipet & Roll 400
111 425	111 200	113 510	112 425	111 625	111 325	111 700	111 710	111 720
All types of samples, analytical method			For pouring: with a weld to retain particles	For PCR and small volumes (≤ 1000 µL)	Capillary analysis systems (PCR, flow cytometry...)	All types of sample (fibrous, paste,...)	Multiple pipettings	
-						✓	-	✓
-							✓	✓
✓	-					✓	-	
✓	-					✓	✓	✓
✓	-					✓	✓	✓
✓	-							
Bag with lateral filter								
Multilayer®: reinforced multicoated complex								
Non-woven								
< 250 µm				< 50 µm	< 20 µm	< 250 µm		
5 to 12 KGy, with certificate								
10 years						5 years		
-40 °C to 80 °C (-40 °F to 176 °F)						-20 °C to 45 °C (48 h) / 80 °C (4 h) -4 °F to 113 °F (48 h) / 176 °F (4 h)		
ISO 7218, ISO 6887 and FDA BAM (Bacteriological Analytical Manual)								
Regulation (EC) No 1935/2004								
In a temperate and dry place, away from humidity and light								
400 mL	2000 mL	3750 mL	400 mL					
50-300 mL	400-1500 mL	400-3750 mL	50-300 mL					
250 mL	-					250 mL		



WEIGHT AND DIMENSIONS

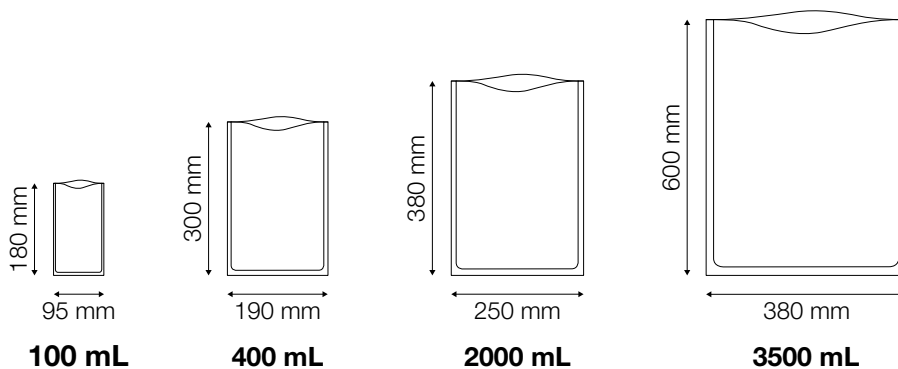

Blender bags with filter

Model	Reference	Pack of	Box of	Box (w x d x h)	Gross weight
BagPage® 100	121 025	25	500	35 x 21 x 11 cm	1.90 kg
BagPage® + 400	122 025	25	500	34 x 22 x 26 cm	5.90 kg
BagPage® + 2000	122 200	25	250	48 x 29 x 14 cm	5 kg
BagPage® + 3500	123 010	10	100	41 x 34 x 12 cm	4.80 kg
BagPage® F 400	122 325	25	500	34 x 22 x 26 cm	5.90 kg
BagPage® R 400	161 025	25	500	34 x 22 x 26 cm	5.70 kg
BagPage® XR 400	122 425	25	400	34 x 22 x 26 cm	6.70 kg
BagFilter® P 400	111 425	25	500	35 x 22 x 15 cm	5.20 kg
BagFilter® P 2000	111 200	25	400	44 x 28 x 13 cm	6.70 kg
BagFilter® P 3500	113 510	10	100	41 x 34 x 13 cm	4.30 kg
BagFilter® S 400	112 425	25	500	35 x 22 x 15 cm	5 kg
BagFilter® Pull-Up® 400	111 625	25	500	34 x 22 x 26 cm	5.60 kg
BagFilter® XF 400	111 325	25	500	35 x 22 x 15 cm	60 kg
BagFilter® Roll 400	111 700	25	500	35 x 22 x 15 cm	5.30 kg
BagFilter® Pipet 400	111 710	25	500	35 x 22 x 15 cm	5.40 kg
BagFilter® Pipet & Roll 400	111 720	25	500	35 x 22 x 15 cm	5.40 kg

Product compatibility



Blender bags with filter

Product	Model	Volume of the bag			
		100 mL	400 mL	2000 mL	3500 mL
GRAVIMETRIC DILUTORS					
DiluFlow®	-	● ⁽²⁾	●		
DiluFlow® Pro	-	● ⁽²⁾	●	● ⁽¹⁾	● ⁽¹⁾
DiluFlow® Elite 5 kg	-	● ⁽²⁾	●	● ⁽¹⁾	● ⁽¹⁾
DiluFlow® Elite 1 kg	-	● ⁽²⁾	●		
LAB BLENDERS					
MiniMix® 100 P CC	100	●			
MiniMix® 100 W CC	100	●			
BagMixer® 400 P	400		●		
BagMixer® 400 W	400		●		
BagMixer® 400 CC	400		●		
BagMixer® S	400		●		
BagMixer® SW	400		●		
JumboMix® 3500 P CC	3500			●	●
JumboMix® 3500 W CC	3500			●	●
JumboMix® 3500 WarmMix® CC	3500			●	●
DISPENSING PUMPS					
FlexiPump®	-	●	●	●	●
FlexiPump® Pro	-	●	●	●	●
LAB ACESORIES					
BagRack® Slide	400		●		
BagRack®	100	●			
	400		●		
	3500			●	●
BagPipet®	-	●	●	●	●
BagClip®	100	●			
	400		●		
	3500			●	●
BagOpen®	100	●			
	400		●	●	
	3500				●
BagSeal®	-	●	●	●	

(1) with Jumbokit option (Ref. 505 006) (2) with BagOpen® 80/100 mL option (Ref. 505 014)



Blender bags without filter

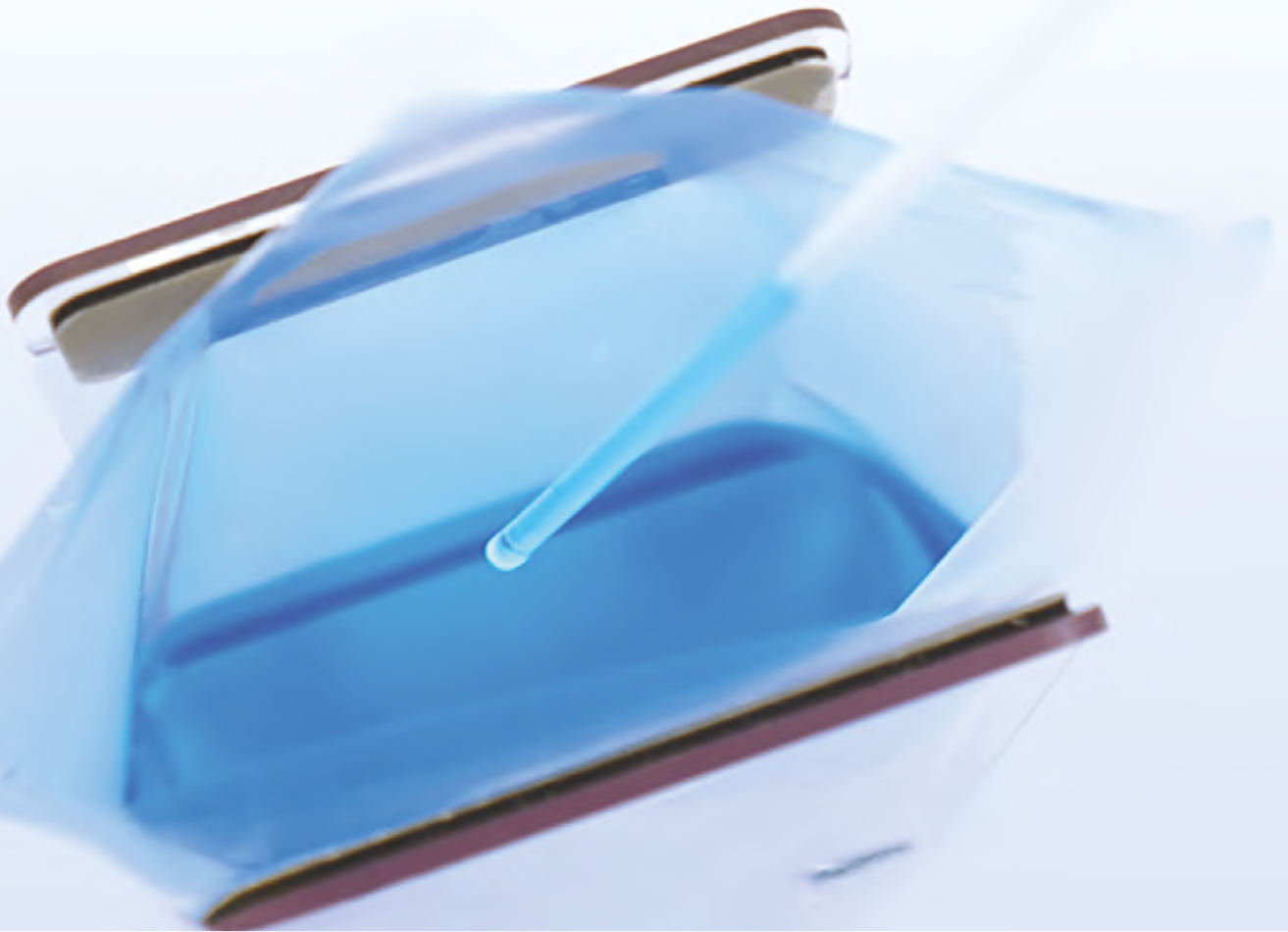

Blender bags without filter

For any sample preparation

BagLight® is designed for any sample preparation. It enables the sampling, dilution, blending the sample, and pipetting in just one and only bag.



Top features of the range

One bag for the entire analysis

More security and time by using the same bag for sampling, blending and pipetting.

Safe

BagLight® is treated by gamma rays.

Approved for food contact.

Ideal for all your applications

BagLight® is adapted to every step of the sample preparation.



No cross-contaminations

There is no contact between the sample and the mixer during homogenization.

Transparent

The transparency of BagLight® allows to quickly visualize the sample contained in the bag during the analysis.

Ultra robust⁽¹⁾

Composed of a multilayer complex and reinforced weldings, BagLight® is compatible with all types of blenders.

(1) Only available with BagLight® MultiLayer®.



Range overview

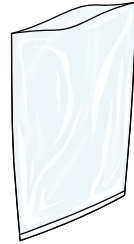

BEST-SELLER	
BagLight® PolySilk®	BagLight® MultiLayer®
Bag without filter	Bag without filter
Transparent	Ultra-resistant

	Top features	
Made in France	✓	✓
Available in 100 mL	✓	-
Available in 400 mL	✓	✓
Available in 2000 and 3500 mL	✓	-
MultiLayer®: reinforced multilayer complex	-	✓
Reinforced weldings	-	✓

BEST-SELLER

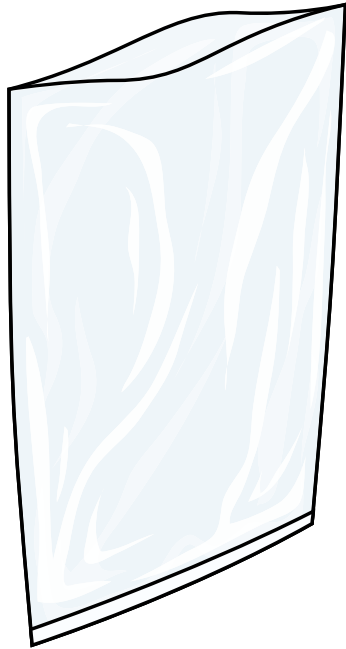

BagLight® PolySilk®

Non-filter Bag

Transparent

Ref. 131 025 (100 mL)
Ref. 132 025 (400 mL)
Ref. 132 050 (400 mL)
Ref. 132 200 (2000 mL)
Ref. 133 023 (3500 mL)

BagLight® PolySilk® is a blender bag without filter. It is ideal for sample preparation. **BagLight® PolySilk®** is the best-seller in the range of non-filter bags.

MAIN FEATURES

- **PolySilk®**: polyolefin complex
- **Resistant**: from -40 °C to 80 °C / -40 °F to 176 °F
- **Flexible and transparent**

APPLICATIONS

BagLight® PolySilk® adapts to all stages of sample preparation. Depending on protocols, it is used in the food, pharmaceutical, cosmetics, environmental, animal health fields and public institutes:

- **BagLight® PolySilk®** 100 mL is used to prepare small samples (1 to 10 ,g) in the pharmaceutical, cosmetics and animal health industries (biopsy preparation).
- **BagLight® PolySilk®** 400 mL is suitable for the analysis of hygiene criteria analysis, incl. 25 g test sample diluted 1/10th.
- **BagLight® PolySilk®** 2000 mL is used for sample preparations up to 1500 mL with a 100/150 g sample size.
- **BagLight® PolySilk®** 3500 mL is particularly used in the food industry for sample pooling up to 375 g.



Blender bags without filter



Food



Environmental



Pharmaceutical



Cosmetics



Veterinary



Public research



Blender bags without filter



BagLight® MultiLayer®

Non-filter Bag

Ultra resistant

Ref. 132 225 (400 mL)

BagLight® MultiLayer® is a blender bag without filter. It is ideal for sample preparation. **BagLight® MultiLayer®** is particularly suitable for hard samples that are difficult to homogenize.

MAIN FEATURES

- **MultiLayer®**: reinforced multicoated complex
- Reinforced weldings
- Resistant: from -40 °C to 80 °C / -40°F to 176 °F



Food



Environmental



Pharmaceutical



Cosmetics



Public research

APPLICATIONS

BagLight® MultiLayer® is used according to protocols in the food, pharmaceutical, cosmetics, environmental fields and public institutes. This ultra resistant bag is used to prepare samples that may pierce the bags (seafood, spikes, medical devices, etc.).



Technical specifications of the range

	BagLight® Polysilk®					BagLight® MultiLayer®
	100	400	400	2000	3500	400
OVERVIEW						
Reference	131 025	132 025	132 050	132 200	133 025	132 225
Ideal	For all uses in the laboratory					
SPECIFICATIONS						
Type of bag	Non-filter bag					
Bag composition	PolySilk®: polyolefin complex					MultiLayer®: multicoated reinforced complex
Gamma ray treated	5 to 12 KGy, with certificate					
Shelf-life	10 years					
Temperature resistance	-40 °C to 80 °C (-40 °F to 176 °F)					
In compliance with	ISO 7218, ISO 6887 and FDA BAM (Bacteriological Analytical Manual)					
Approved for food contact	Regulation (EC) No 1935/2004					
Storage conditions	In a temperate and dry place, away from humidity and light					
VOLUMES						
Maximal blending volume	100 mL	400 mL	400 mL	2000 mL	3750 mL	400 mL
Optimal blending volume	5-50 mL	50-300 mL	50-300 mL	400-1500 mL	400-3750 mL	50-300 mL

WEIGHT AND DIMENSIONS

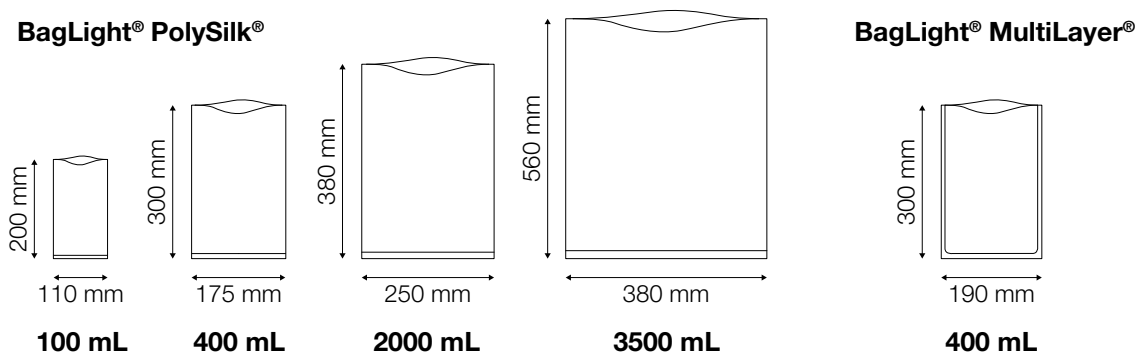

Model	Reference	Pack of	Box of	Box (w x d x h)	Gross weight
BagLight® PolySilk® 100	131 025	25	500	31 x 22 x 7 cm	1.80 kg
BagLight® PolySilk® 400 (x25)	132 025	25	500	35 x 21 x 11 cm	4.10 kg
BagLight® PolySilk® 400 (x50)	132 050	50	500	35 x 21 x 11 cm	4.10 kg
BagLight® PolySilk® 2000	132 200	25	500	48 x 29 x 14 cm	10.20 kg
BagLight® PolySilk® 3500	133 025	25	250	41 x 34 x 12 cm	7.70 kg
BagLight® Multilayer® 400	132 225	25	500	35 x 21 x 11 cm	4.60 kg



Product compatibility

Blender bags without filter

Product	Model	Volume of the bag without filter			
		100 mL	400 mL	2000 mL	3500 mL
GRAVIMETRIC DILUTORS					
DiluFlow®	-	● ⁽²⁾	●		
DiluFlow® Pro	-	● ⁽²⁾	●	● ⁽¹⁾	● ⁽¹⁾
DiluFlow® Elite 5 kg	-	● ⁽²⁾	●	● ⁽¹⁾	● ⁽¹⁾
DiluFlow Elite 1 kg	-	● ⁽²⁾	●		
LAB BLENDERS					
MiniMix® 100 P CC	100	●			
MiniMix® 100 W CC	100	●			
BagMixer® 400 P	400		●		
BagMixer® 400 W	400		●		
BagMixer® 400 CC	400		●		
BagMixer® S	400		●		
BagMixer® SW	400		●		
JumboMix® 3500 P CC	3500			●	●
JumboMix® 3500 W CC	3500			●	●
JumboMix® 3500 WarmMix® CC	3500			●	●
DISPENSING PUMPS					
FlexiPump®	-	●	●	●	●
FlexiPump® Pro	-	●	●	●	●
LAB ACCESSORIES					
BagRack® Slide	400		●		
BagRack®	100	●			
	400		●		
	3500			●	●
BagPipet®	-	●	●	●	●
BagClip®	100	●			
	400		●		
	3500			●	●
BagOpen®	100	●			
	400		●	●	
	3500				●
BagSeal®	-	●	●	●	

(1) with Jumbo kit option (Ref. 505 006) (2) with BagOpen® 80/100 mL option (Ref. 505 014)



Blender bags with culture media

Your diluent ready in minutes!

instaBAG[®] is a filter bag with integrated pre-dosed dehydrated medium. The bag of pre-dosed dehydrated culture medium is directly integrated into the bag. Simply add a sample and purified sterile water. The culture medium dissolves completely during blending. Preparation is immediate.



Top features of the range

Just add sterile and purified water

The pouch of dehydrated pre-dosed culture medium integrated in the bag dissolves completely during blending: the preparation is instant (≤ 3 min).

PATENTED

Space saving

100 glass bottles



100 *instaBAG*[®]

No waste

100% of the preparation is used instead of 13%.

Comparison between 3 *instaBAG*[®] and 1 (5 L) pouch for 3 analyses.



Non-woven filter identical to the bag filter

Less garbage

25 kg of waste instead of 40 kg.

Comparison between *instaBAG*[®] (bag + diluent + sample) and ready-to-use medium bottle (bag + diluent + sample) for 100 analyses.

Green

No water transported.



Long shelf life

Light and humidity-proof aluminum pouch. Zip pouch with desiccant: optimal conservation after opening.

Range overview



NEW		
<i>instaBAG</i> ® BPW	<i>instaBAG</i> ® Fraser ½	<i>instaBAG</i> ® MILK
Filter bag with dehydrated media		
The integrated media	Ideal for selective enrichment	Ideal for the analysis of chocolate products

Top features			
Type of dehydrated media	BPW	Supplemented Fraser ½	MILK
In compliance with ISO 11133 standard	✓	✓	-
Bag with lateral non-woven filter	✓	✓	✓
For 10 g sample	✓	-	-
For 25 g sample	✓	✓	✓
For sample 100 g, 250 g, 350 g	-	-	✓



instaBAG® BPW

Filter bag with dehydrated media

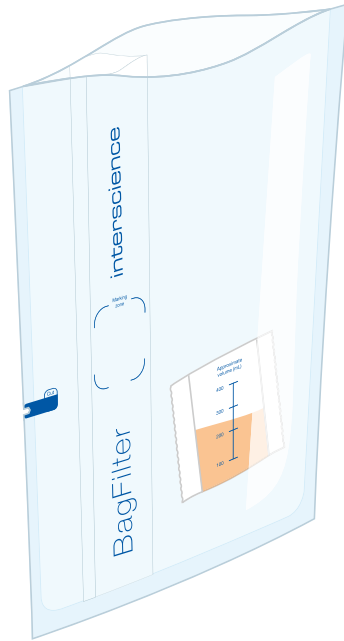

The integrated media

Ref. 114 090 (BPW 90 mL)

Ref. 114 225 (BPW 225 mL)

instaBAG® BPW is a filter bag which includes a dehydrated pre-dosed media, allowing a 2-in-1 process: media and sample preparation for microbiological analyses.



AUTOMATE DILUTION

DiluFlow® Elite 5 kg - Gravimetric dilutor

Ref. 503 105

For more information, please refer to page 23

MAIN FEATURES

- Filter bag with dehydrated pre-dosed media
- Type of dehydrated media: buffered peptone water
- Filter porosity: < 250 micrometers
- Compatible with any laboratory blender

APPLICATIONS

instaBAG® BPW is used in the food industry and public institutes. It allows the suspension of 10 or 25 g solid samples in peptone water diluted to 1/10th according to ISO 7218 for the enumeration of quality indicators. It is also used for non-selective pre-enrichment for the detection of *Salmonella* spp. (ISO 6579) and Enterobacteriaceae (ISO 21528-1). This medium is validated according to ISO 11133.



Food



Public research



instaBAG® Fraser 1/2

Filter bag with dehydrated media

Ideal for selective enrichment

Ref. 114 220 (Fraser 1/2 225 mL)

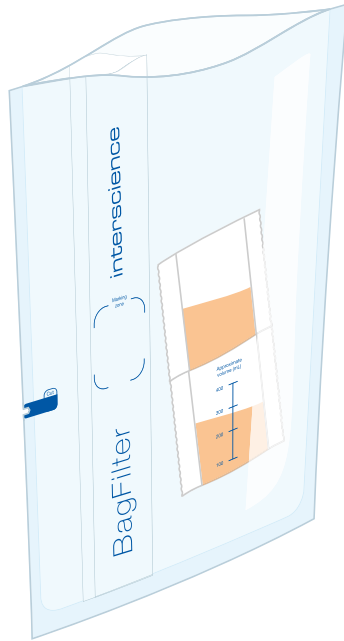

Blender bags with culture media

instaBAG® Fraser 1/2 is a filter bag which encloses a dehydrated pre-dosed media, allowing a 2-in-1 process: media and sample preparation for microbiological analyses. Fraser 1/2 is used as a medium for primary selective enrichment for the detection and enumeration of *Listeria monocytogenes*.



SOLUBILIZATION OF MEDIA AND BACTERIAL EXTRACTION

BagMixer® 400 SW - Lab blender

Ref. 025 100

For more information, please refer to page 47

MAIN FEATURES

- Filter bag with dehydrated pre-dosed media
- Type of dehydrated media: supplemented Fraser 1/2
- Filter porosity: < 250 micrometers
- Compatible with any laboratory blender

APPLICATIONS

instaBAG® supplemented Fraser 1/2 is used in the food industry and public institutes research. Fraser allows the suspension of solid samples of 25 g diluted at 1/10th for the detection of *Listeria monocytogenes*. This selective media is already supplemented. It is validated according to ISO 11133.



Food



Public research



NEW

instaBAG® MILK

Filter bag with dehydrated media

Ideal for the analysis of chocolate products

- Ref. 115 022 (MILK 225 g)
- Ref. 115 090 (MILK 900 g)
- Ref. 115 225 (MILK 2250 g)
- Ref. 115 337 (MILK 3375 g)

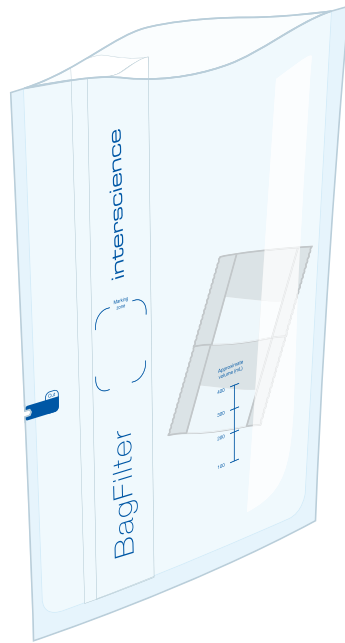

instaBAG® MILK is a filter bag which encloses a pre-dosed milk powder media allowing a 2-in-1 process: media and sample preparation for microbiological analyses. It is ideal for the analysis of chocolate products.

MAIN FEATURES

- Filter bag with dehydrated pre-dosed media
- Type of dehydrated media: French milk powder from Normandy
- Filter porosity: < 250 micrometers
- Compatible with any laboratory blender

APPLICATIONS

instaBAG® MILK is used in the food industry and public institutes for the analysis of chocolate products (cocoa powder, chocolate bars...). According to ISO 6887-4, the use of UHT milk or reconstituted skimmed milk powder (100 g/L of water, sterilized after reconstitution) is recommended as a pre-enrichment media to detect pathogens as *Salmonella* spp. and STEC.



Food



Public research



Sterile water is used in microbiology, cell culture and physico-chemistry laboratories, particularly in the preparation of culture media.

Steriwater® is a range of products dedicated to the distribution of sterile water with gravimetric dilutors, peristaltic pumps, bags with media and distribution sets.

Therefore it is suitable for applications related to sterile water production in laboratories.



Instantaneous
Sterile water for your analyses

Easy to use
No need to autoclave
the bottle and the water

Ideal with *instaBAG*®
All set for analysis

Blender bags with culture media

Sample dilution

Filter tubing

Dispensing assembly with 0.2 µm filter

DiluFlow® Elite

Gravimetric dilutor

instaBAG®

Bag with culture media



Preparation of sterile water

Filter tubing

Dispensing assembly with 0.2 µm filter

FlexiPump®

Peristaltic pump



	DiluFlow® DiluFlow® Pro DiluFlow® Elite (Single pump)	DiluFlow® DiluFlow® Pro DiluFlow® Elite (Double pump)	FlexiPump®	FlexiPump® Pro
Dispensing assembly with 0.2 µm filter (GL45 - Ø 6.4 mm)	Ref. 513 050		Ref. 561 050	
Dispensing assembly + Y with 0.2 µm filter (GL45 - Ø 6.4 mm)		Ref. 513 051		Ref. 562 051
Tubings for pump with filter 0.2 µm (Ø 6.4 mm)	Ref. 513 052	Ref. 513 052	Ref. 513 052	Ref. 513 052
Holder for dispensing assembly set with 0.2 µm filter	Ref. 513 053	Ref. 513 053		



Food



Environmental



Veterinary



Public research



Technical specifications of the range

				<i>instaBAG</i> [®]		
				BPW 90	BPW 225	Fraser ½
OVERVIEW						
Reference	114 090		114 225		114 220	
Ideal	For pre-enrichment			For selective enrichment		
Precut for pipetting				✓		
Marking zone				✓		
Volume index				✓		
SPECIFICATIONS						
Type of bag	Bag with lateral filter					
Bag composition	MultiLayer [®] : multicoated reinforced complex					
Type of filter	Non-woven					
Bag volume	400 mL					
Filter porosity	< 250 µm					
Type of dehydrated media	Buffered peptone water			Supplemented Fraser ½		
Weight of dehydrated media	1.8 g		4.5 g		13 g	
Sample weight	10 g (± 5%)		25 g (± 5%)			
Composition for 1 L media	Peptone: 10.0 g Sodium chloride: 5.0 g Anhydrous disodium phosphate: 3.6 g Monopotassium phosphate: 1.5 g			Enzymatic digest of animal tissues: 5.0 g Casein enzymatic digest: 5.0 g Meat extract: 5.0 g Yeast extract: 5.0 g Sodium chloride: 20.0 g Disodium hydrogen phosphate dihydrate: 12.0 g Potassium dihydrogen phosphate: 1.35 g Esculine: 1.0 g Lithium chloride: 3.0 g Sodium salt of nalidixic acid: 0.01 g Acriflavine hydrochloride: 0.0125 g Iron (III) ammoniacal citrate: 0.5 g		
Blending time	1 minute			2 minutes		
Gamma ray treated	10 to 25 kGy, with certificate					
Shelf life	36 months			18 months		
In compliance with	ISO 11133, ISO 11290-2, ISO 21528-1, ISO 7218, ISO 6579, ISO 6887 and FDA BAM (Bacteriological Analytical Manual)			ISO 11133, ISO 11290-2, ISO 7218, ISO 6887 and FDA BAM (Bacteriological Analytical Manual)		
Approved for food contact	Regulation (EC) No 1935/2004					
Storage conditions	Temperature from 6 °C to 30 °C (42.8 °F to 86 °F). Close the pouch after opening to avoid humidity.			Temperature from 10 °C to 30 °C (50 °F to 86 °F). Close the pouch after opening to avoid humidity.		

WEIGHT AND DIMENSIONS

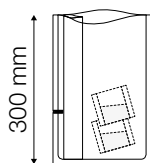

400 mL

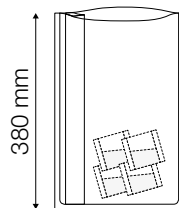

2000 mL

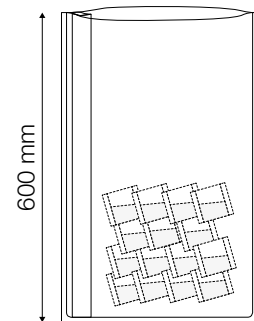

3500 mL



<i>instaBAG</i> [®]			
MILK 225	MILK 900	MILK 2250	MILK 3375
115 022	115 090	115 225	115 337
For the analysis of chocolate products			
✓	✓	-	-
✓	-	-	-
✓	-	-	-
Bag with lateral filter			
MultiLayer [®] : multicoated reinforced complex			
Non-woven			
400 mL	2000 mL	3500 mL	
< 250 µm			
Skimmed milk powder			
21.8 g	87.4 g	218.4 g	327.7 g
25 g (± 5%)	100 g (± 5%)	250 g (± 5%)	375 g (± 5%)
Total fat: 0.8 g of which saturated fatty acid: 0.5 g Carbohydrates: 52 g Proteins: 36 g Salt: 1.1 g Sodium: 0.42 g Mineral salts: 7.8 g Calcium: 1230 mg 100 g of powder + 930 mL of water gives 1 L of skimmed milk (100 g/L)			
3 minutes			
10 to 25 kGy, with certificate			
12 months			
ISO 7218, ISO 6887 and FDA BAM (Bacteriological Analytical Manual)			
Regulation (EC) No 1935/2004			
Temperature from 15 °C to 25 °C (59 °F to 77 °F). Close the pouch after opening to avoid humidity			

Model	Reference	Aluminium pouch of	Box of	Box (w x d x h)	Gross weight
<i>instaBAG</i> [®] BPW 90 (400 mL)	114 090	10	100	34 x 28 x 11 cm	1.60 kg
<i>instaBAG</i> [®] BPW 225 (400 mL)	114 225	10	100	34 x 28 x 11 cm	1.90 kg
<i>instaBAG</i> [®] Fraser ½ (400 mL)	114 220	10	80	34 x 28 x 11 cm	2.25 kg
<i>instaBAG</i> [®] MILK 225 (400 mL)	115 022	10	120	38.5 x 28.5 x 25 cm	4.95 kg
<i>instaBAG</i> [®] MILK 900 (2000 mL)	115 090	5	40	37 x 29 x 12 cm	5.50 kg
<i>instaBAG</i> [®] MILK 2250 (3500 mL)	115 225	5	30	48.5 x 38.5 x 25 cm	9.40 kg
<i>instaBAG</i> [®] MILK 3375 (3500 mL)	115 337	5	20	48.5 x 38.5 x 25 cm	8.85 kg



Product compatibility

Product	Model	instaBAG® bag volume		
		400 mL	2000 mL	3500 mL
GRAVIMETRIC DILUTORS				
DiluFlow®	-	•		
DiluFlow® Pro	-	•	• ⁽¹⁾	• ⁽¹⁾
DiluFlow® Elite 5 kg	-	•	• ⁽¹⁾	• ⁽¹⁾
DiluFlow® Elite 1 kg	-	•		
LAB BLENDERS				
MiniMix® 100 P CC	100			
MiniMix® 100 W CC	100			
BagMixer® 400 P	400	•		
BagMixer® 400 W	400	•		
BagMixer® 400 CC	400	•		
BagMixer® 400 S	400	•		
BagMixer® 400 SW	400	•		
JumboMix® 3500 P CC	3500		•	•
JumboMix® 3500 W CC	3500		•	•
JumboMix® 3500 WarmMix® CC	3500		•	•
DISPENSING PUMPS				
FlexiPump®	-	•	•	•
FlexiPump® Pro	-	•	•	•
LAB ACCESSORIES				
BagRack® Slide	400	•		
BagRack®	100			
	400	•		
	3500		•	•
BagPipet®	-	•	•	•
BagClip®	100			
	400	•		
	3500		•	•
BagOpen®	100			
	400	•	•	
	3500			•
BagSeal®	-	•	•	

(1) with Jumbo kit option (Ref. 505 006)



Sterile sampling bags

Sterile sampling bags

Roll, stick and that's it!

RollBag® is a sampling bag with a sticker closure for sample collection, transport and analysis of all types of samples from the sampling site to the laboratory. The different sizes adapt to all types of any liquid or solid sample.



Top features of the range

Waterproof closure, with just a sticker!

Simply close your bag with the built-in sticker for a waterproof extra-resistant closure, without any extra tools.

Metal-free

RollBag® contains no wire, so it is much easier to dispose of than a conventional wire bag. It can be treated as soft waste (shredded, incinerated).

Safe

RollBag® is gamma sterilised and approved for food contact. The pre-cut at the top of the bag ensures unique and sterile packaging.



Robust

RollBag® is made of a puncture-resistant PolySilk® film. The sealings at the bottom of the bag are reinforced to resist to blending.

Marking zone

The RollBag® marking area makes it easy to sort and identify the sample.

Space saving



NEW



RollBag®

Sterile sampling bag

Easy sticker closure

Ref. 145 072 (7.5 x 20) / Ref. 145 112 (11 x 20)
Ref. 145 115 (11 x 25) / Ref. 145 142 (14 x 23)
Ref. 145 113 (11 x 30) / Ref. 145 143 (14 x 33)
Ref. 145 173 (17.5 x 30) / Ref. 145 174 (17.5 x 40)
Ref. 145 253 (25 x 38) / Ref. 145 255 (25 x 50)
Ref. 145 385 (38 x 56)

RollBag® is a sampling bag with sticker closure for collecting, transporting and analyzing samples from the sampling site to the laboratory. Different sizes adapt to all types of liquid or solid samples.

MAIN FEATURES

- Built-in sticker closure, 100% metal-free
- Marking zone
- Single sterile packaging
- Film in PolySilk®, polyolefin complex

APPLICATIONS

RollBag® is used for the sampling of all types of samples in production. It allows the analysis of quality indicators in the food industry or the detection of pathogens on raw materials in the pharmaceutical field.



Sterile sampling bags



Food



Environmental



Pharmaceutical



Cosmetics



Veterinary



Public research



Technical specifications of the range

	RollBag®				
	7.5 x 20	11 x 20	11 x 25	14 x 23	11 x 30
OVERVIEW					
Reference	145 072	145 112	145 115	145 142	145 113
Ideal	For various types of any solid or liquid samples from the sampling site to the laboratory				
Built-in sticker for bag closure	✓				
Marking zone	✓				
DIMENSIONS					
Width (cm)	7.5 cm	11 cm		14 cm	11 cm
Width (inch)	3 inch	4.3 inch		5.5 inch	4.3 inch
Height (cm)	20 cm		25 cm	23 cm	30 cm
Height (inch)	8 inch		10 inch	9 inch	12 inch
Thickness (µm)	70 µm				
Thickness (mil)	3 mil				
SPECIFICATIONS					
Compatibility with Interscience lab blender	MiniMix®				
Number of stickers	1				
Type of bag	Sampling bag				
Bag composition	PolySilk®: polyolefin complex (bag) - polypropylene (closure sticker)				
Gamma ray treated	5 to 12 kGy, with certificate				
Shelf-life	5 years				
Resistance to temperature	-20 °C to 45 °C (48 h) / 80 °C (4 h) - -4 °F to 113 °F (48 h) / 176 °F (4 h)				
In compliance with	ISO 7218, ISO 6887 and FDA BAM (Bacteriological Analytical Manual)				
Approved for food contact	Regulation (EC) No 1935/2004				
Storage conditions	In a temperate and dry place, away from humidity and light				
VOLUMES					
Max. volume (mL)	110 mL	200 mL	400 mL	400 mL	620 mL
Max. volume (oz)	4 oz	7 oz	14 oz	14 oz	21 oz
Max. blending volume (mL)	65 mL	160 mL	180 mL	200 mL	145 mL
Max. blending volume (oz)	2 oz	5 oz	6 oz	7 oz	5 oz
Optimal blending volume (mL)	5-40 mL	5-80 mL	5-110 mL	5-130 mL	5-100 mL
Optimal blending volume (oz)	0.15-1.5 oz	0.15-3 oz	0.15-4 oz	0.15-5 oz	0.15-4 oz



RollBag®					
14 x 33	17.5 x 30	17.5 x 40	25 x 38	25 x 50	38 x 56
145 143	145 173	145 174	145 253	145 255	145 385
For various types of any solid or liquid samples from the sampling site to the laboratory					
✓					
✓					
14 cm	17.5 cm		25 cm		38 cm
5.5 inch	7 inch		10 inch		15 inch
33 cm	30 cm	40 cm	38 cm	50 cm	56 cm
13 inch	12 inch	16 inch	15 inch	20 inch	22 inch
70 µm			100 µm		
3 mil			4 mil		
MiniMix® and BagMixer®	BagMixer®		JumboMix®		
1			2		
Sampling bag					
PolySilk®: polyolefin complex (bag) - polypropylene (closure sticker)					
5 to 12 kGy, with certificate					
5 years					
-20 °C to 45 °C (48 h) / 80 °C (4 h) - -4 °F to 113 °F (48 h) / 176 °F (4 h)					
ISO 7218, ISO 6887 and FDA BAM (Bacteriological Analytical Manual)					
Regulation (EC) No 1935/2004					
In a temperate and dry place, away from humidity and light					
850 mL	1100 mL	1800 mL	2500 mL	4500 mL	10 000 mL
29 oz	38 oz	61 oz	85 oz	152 oz	340 oz
350 mL	550 mL	650 mL	1000 mL	2500 mL	5000 mL
12 oz	19 oz	22 oz	34 oz	84 oz	170 oz
50-250 mL	50-350 mL	50-400 mL	200-600 mL	400-1000 mL	500-3000 mL
1.5-9 oz	1.5-12 oz	1.5-14 oz	7-21 oz	13-34 oz	17-102 oz



WEIGHT AND DIMENSIONS

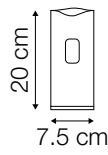

RollBag® 7.5 x 20 - Ref. 145 072	
Box of	500 bags
Box (w x d x h)	15.5 x 25.5 x 13 cm
Gross weight	1.30 kg

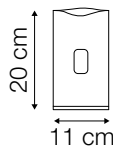

RollBag® 11 x 20 - Ref. 145 112	
Box of	500 bags
Box (w x d x h)	15.5 x 25.5 x 13 cm
Gross weight	1.70 kg

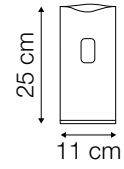

RollBag® 11 x 25 - Ref. 145 115	
Box of	500 bags
Box (w x d x h)	15.5 x 25.5 x 13 cm
Gross weight	2.20 kg

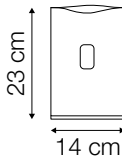

RollBag® 14 x 23 - Ref. 145 142	
Box of	500 bags
Box (w x d x h)	15.5 x 25.5 x 13 cm
Gross weight	2.40 kg

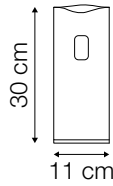

RollBag® 11 x 30 - Ref. 145 113	
Box of	500 bags
Box (w x d x h)	35 x 21 x 10.5 cm
Gross weight	2.40 kg

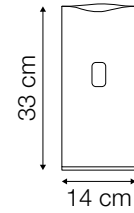

RollBag® 14 x 33 - Ref. 145 143	
Box of	500 bags
Box (w x d x h)	35 x 21 x 10.5 cm
Gross weight	3.50 kg

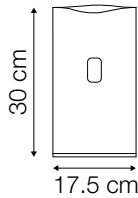

RollBag® 17.5 x 30 - Ref. 145 173	
Box of	500 bags
Box (w x d x h)	35 x 21 x 10.5 cm
Gross weight	3.70 kg

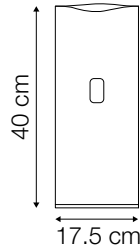

RollBag® 17.5 x 40 - Ref. 145 174	
Box of	500 bags
Box (w x d x h)	44 x 27.5 x 10 cm
Gross weight	5 kg

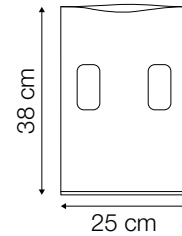

RollBag® 25 x 38 - Ref. 145 253	
Box of	250 bags
Box (w x d x h)	44 x 27.5 x 10 cm
Gross weight	4.90 kg

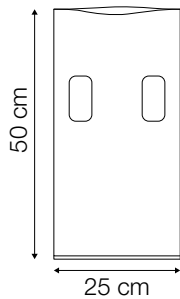

RollBag® 25 x 50 - Ref. 145 255	
Box of	250 bags
Box (w x d x h)	44 x 27.5 x 10 cm
Gross weight	6.30 kg

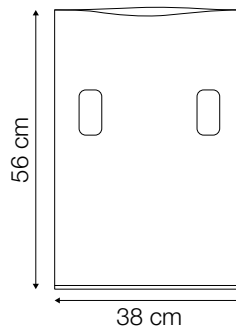

RollBag® 38 x 56 - Ref. 145 385	
Box of	250 bags
Box (w x d x h)	41 x 33.5 x 11.3 cm
Gross weight	10.40 kg

Product compatibility



Product	Model	RollBag®				
		7.5 x 20 11 x 20 11 x 25 14 x 23 11 x 30	14 x 33	17.5 x 30 17.5 x 40	25 x 38	25 x 50 38 x 56
GRAVIMETRIC DILUTORS						
DiluFlow®	-	● ⁽²⁾	●	●		
DiluFlow® Pro	-	● ⁽²⁾	●	●	● ⁽¹⁾	● ⁽¹⁾
DiluFlow® Elite 5 kg	-	● ⁽²⁾	●	●	● ⁽¹⁾	● ⁽¹⁾
DiluFlow® Elite 1 kg	-	● ⁽²⁾	●	●		
LAB BLENDERS						
MiniMix® 100 P CC	100	●	●			
MiniMix® 100 W CC	100	●	●			
BagMixer® 400 P	400		●	●		
BagMixer® 400 W	400		●	●		
BagMixer® 400 CC	400		●	●		
BagMixer® 400 S	400		●	●		
BagMixer® 400 SW	400		●	●		
JumboMix® 3500 P CC	3500				●	●
JumboMix® 3500 W CC	3500				●	●
JumboMix® 3500 WarmMix® CC	3500				●	●
DISPENSING PUMPS						
FlexiPump®	-	●	●	●	●	●
FlexiPump® Pro	-	●	●	●	●	●
LAB ACCESSORIES						
BagRack® Slide	400		●	●		
BagRack®	100	●	●			
	400		●	●		
	3500				●	●
BagPipet®	-	●	●	●	●	●
BagOpen®	100	●	●			
	400		●	●		
	3500				●	●

(1) with Jumbo kit option (Ref. 505 006) (2) with BagOpen® 80/100 mL option (Ref. 505 014)



Autoclave deodorants

Give some air to your lab!

Anabac® autoclave deodorant gives your laboratory a fragrant touch.



Top features of the range

Fresh air in your laboratory

Anabac® eliminates odors from the autoclaves and perfumes the room air.

Easy to use

Anabac® is compatible with all autoclaves and does not affect the autoclaving process.



Environmentally friendly⁽¹⁾

Easily biodegradable, the range is operator and environmentally friendly.

Fragrance 100% natural origin⁽¹⁾

Based on natural extracts, **Anabac® Natural** is ECOCERT certified according to the Cosmos-standard reference.

(1) valid only on the **Anabac® Natural** range.



Anabac® Citrus

Autoclave deodorant

Lemon fragrance

Ref. 320 300



Placed in the autoclave, **Anabac® Citrus** provides a discreet and perfumed touch in the lab.

MAIN FEATURES

- Biodegradable
- No impact on autoclaving



Food

APPLICATIONS

Anabac® is used in laboratories where sterilization cycles, destruction of microorganisms, culture media, decontamination of materials are carried out.



Environmental



Pharmaceutical



Cosmetics



Veterinary



Public research



Anabac® Classic

Ref. 320 100

**Eucalyptus
fragrance**



Anabac® Poma

Ref. 320 200

**Apple
fragrance**



Anabac® Peach

Ref. 320 500

**Peach
fragrance**



Anabac® Berry

Ref. 320 600

**Berries
fragrance**



Anabac® Natural Coconut

Autoclave deodorant

Coconut fragrance

Ref. 321 100

Anabac® Natural Coconut is an autoclave deodorant with a 100% natural fragrance. It refreshes the laboratory and provides a pleasant scent after autoclaving.

MAIN FEATURES

- 100% natural origin fragrance, based on natural extracts
- ECOCERT certified perfume according to Cosmos-Standard
- Biodegradable
- Compatible with any sterilization and decontamination autoclave
- No impact on autoclaving

APPLICATIONS

Anabac® is used in laboratories where sterilization cycles, destruction of microorganisms, culture media, decontamination of materials are carried out.



Anabac® Natural Vanilla

Ref. 321 200

**Vanilla
fragrance**



Anabac® Natural Mimosa

Ref. 321 300

**Mimosa
fragrance**



Food



Environmental



Pharmaceutical



Cosmetics



Veterinary



Public research



Technical specifications of the range

Anabac®								
	Classic	Poma	Citrus	Peach	Berry	Natural Coconut	Natural Vanilla	Natural Mimosa
OVERVIEW								
Reference	320 100	320 200	320 300	320 500	320 600	321 100	321 200	321 300
Fragrance	Eucalyptus	Apple	Lemon	Peach	Berries	Coconut	Vanilla	Mimosa
Pot of	100 capsules					50 capsules		

WEIGHT AND DIMENSIONS

Model	Reference	Box (w x d x h)	Gross weight
Anabac® Classic	320 100	12 x 10 x 8 cm	0.16 kg
Anabac® Poma	320 200	12 x 10 x 8 cm	0.16 kg
Anabac® Citrus	320 300	12 x 10 x 8 cm	0.16 kg
Anabac® Peach	320 500	12 x 10 x 8 cm	0.16 kg
Anabac® Berry	320 600	12 x 10 x 8 cm	0.16 kg
Anabac® Natural Coconut	321 100	12 x 10 x 8 cm	0.10 kg
Anabac® Natural Vanilla	321 200	12 x 10 x 8 cm	0.10 kg
Anabac® Natural Mimosa	321 300	12 x 10 x 8 cm	0.10 kg

Interscience manufacturer's warranty

Since 1979, customers from all over the world have trusted us. We are committed to designing for them high quality products and fully supporting them with their investment.

SEVERE MANUFACTURING TESTS

All our machines are **individually checked and calibrated** according to strict procedures. Each instrument undergoes endurance tests. This represents between 5 and 25 tests per device.



LONG SERVICE LIFE

We design custom parts and use **high quality materials** for the manufacture of our machines. The **sustainability of our products** is essential and as a matter of principle we do not practice planned obsolescence.

SPARE PARTS AVAILABLE

We have secured our supplies by having local and reliable suppliers, and all our parts are rigorously examined and tested. We keep spare parts in stock for a **minimum period of 10 years** after the production of the manufacture of the last unit.

OUR WARRANTY

During the warranty period, **we commit to undertake the repairs or replace the defective device** used under normal conditions of use and maintained according to our recommendations.⁽¹⁾

1 year	3 years
<ul style="list-style-type: none">• Gravimetric dilutors• Peristaltic pumps• Automatic platers• Real-time incubators and colony counters	<ul style="list-style-type: none">• Lab blenders• Colony counters• Inhibition zone readers



Our Customer Support team, together with engineers from the R&D center, are committed to solving any difficulty you may encounter.

CERTIFICATION

ISO 9001: All products are manufactured for Interscience by interlab, an ISO 9001 certified company.

CE: Our products are certified and comply with European directives 2006/42/EC, 2014/30/EU, 2014/35/EU, RoHS 2011/65/EU and WEEE 2012/19/EU.

(1) subject to registration of the warranty card

Contact us

We have an international network that allows us to have a close relationship with all our customers, everywhere.
Our multilingual sales team is at your service to answer all your questions.

You can also contact us by filling out the information request form on our website.



FRANCE

30 chemin du bois des arpent
78860 Saint Nom la Bretèche - FRANCE

Phone: +33 (0)1 34 62 63 26

Information: info@interscience.com

Orders: orders@interscience.com



WORLDWIDE

30 chemin du bois des arpent
78860 Saint Nom la Bretèche - FRANCE

Phone: +33 1 34 62 63 27

Information: info@interscience.com

Orders: orders@interscience.com



PUYCAPEL - Factory and R&D center

INTERLAB
Route de Jalenques
15340 PUYCAPEL



USA/CANADA

32 Cummings Park
Woburn, MA 01801
USA

Phone: +1 781 937 0007

Information: sales.usa@intersciencelab.com

Orders: orders.usa@intersciencelab.com



Customer Support



We are committed to supporting you when using your equipment. We offer a wide range of services depending on your location.

WORLDWIDE

Email: tech@interscience.com

Phone: +33 (0)1 34 62 63 24

USA/CANADA

Email: support@intersciencelab.com

Phone: +1 781 937 0007

SOUTH EAST ASIA

Email: support.asia@interscience.com

Phone: +65 9880 9360

CHINA

Email: tech.china@interscience.cn

Phone: +86 021 6473 9327

JAPAN

Email: support.japan@interscience.com

Phone: +81 3 6712 9715



D-A-CH

Krautgartenstraße 30,
65205 Wiesbaden - GERMANY

Phone: +49 611 723 87 770

Information: sales.germany@interscience.com

Orders: orders@interscience.com



Showroom



SOUTH-EAST ASIA & OCEANIA

60 Paya Lebar Road #08-57, Paya Lebar Square
SINGAPORE 409051

Phone: +65 6977 7232

Information: sales.asia@interscience.com

Orders: orders@interscience.com



Showroom



CHINA

Rm1903, No.798 ZhaoJiaBang Rd,
XuHui District Shanghai,
200030 - CHINA

Phone: +86 178 2123 6642

Information: sales.china@interscience.cn

Orders: orders@interscience.com



Showroom



Application Support



JAPAN

GoodOffice Shinagawa 10F, 1-23-19,
KitaShinagawa, Shinagawa-ku,
Tokyo, 140-0001 - JAPAN

Phone: +81 3 6712 9715

Information: sales.japan@interscience.com

Orders: orders@interscience.com



Showroom



Application Support

Service offer

Ensure ongoing performance of your equipment, cover it against unexpected failures and choose the formula most adapted to your needs:

WARRANTY EXTENSION

SIMPLE CARE
Extends equipment lifespan

GLOBAL CARE
Full service included

Preventive Maintenance			
Wearing parts and labor	-	✓	✓
Metrological and mechanical verifications	-	✓	✓
Software and hardware updates	-	✓	✓
Temporary replacement unit on request	-	✓	✓
On-site Interscience service engineer visit or service hub maintenance	-	✓	✓
Carriage and travel costs	-	✓	✓
Maintenance report	-	✓	✓
Application Support			
Remote application guidance	-	✓	✓
Corrective Maintenance			
Spare parts and labor	✓	-	✓
On-site Interscience service engineer visit or service hub maintenance	-	-	✓
Temporary replacement unit on request	-	-	✓
Carriage and travel costs	-	-	✓
Priority assistance	-	-	✓

All services are offered for a duration of 1 year, under conditions, availability depending on the area and subject to General Terms and Conditions of Sale. Warranty extension is only available at equipment purchase and limited in time, subject to warranty card registration.

Training courses

We organize scientific, technical, commercial and maintenance training on all our solutions:

- Scientific webinar
- Product training
- Application training
- Technical training
- Evaluation of your protocols in our labs
- Training/implementation of IQOQ

These training courses are designed to meet your needs and are open to all our customers and partners. They can either take place in your laboratory, in our showrooms or remotely.

Contact us for any request at info@interscience.com



We will be there!



We participate in many trade shows, congresses and conferences around the world.
Come and discover our products and meet our sales teams.

AMERICA



EUROPE



ASIA



Complete list, dates and information on
www.interscience.com

Your local distributor

interscience

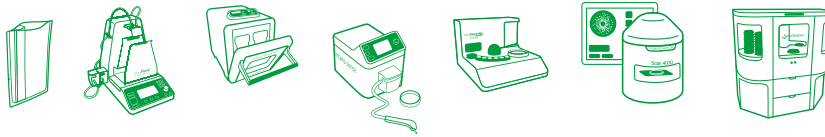

PARIS

Phone: +33 (0)1 34 62 62 61
Email: info@interscience.com

BOSTON

Phone: +1 781 937 0007
Email: sales.usa@intersciencelab.com

SINGAPORE

Phone: +65 6977 7232
Email: sales.asia@interscience.com

FRANKFURT

Phone: +49 611 723 87 770
Email: sales.germany@interscience.com

SHANGHAI

Phone: +86 021-64739390
Email: sales.china@interscience.cn

TOKYO

Phone: +81 3 6712 9715
Email: sales.japan@interscience.com

EN Big size : 7725 Catalogue_EN_0723. Pictures and information in this brochure are not contractually binding. This document is the translation of the french brochure and is not contractually binding. INTERSCIENCE reserves the right to change or improve the specifications of its products without notice. Please visit www.interscience.com for current updates and additional information. RCS 950 356 220 Versailles. INTERSCIENCE SARL F78860. Printed by Accent Tonic. Registered trademarks: AGARTOP® - Anabac® - PickupBag BagPickUp® - BlenderBag BagBlender® - BagClip® - BagControl® - BagFilter® - BagFilter Pull-Up® - BagFilter Universal® - BAGHOLDER® - BagLight® - BagLight Universal® - BagLite® - BagMixer® - BagMixer Crocodile® - BagOpen® - BagOpen GeckoGrip® - BagPage® - BagPage Universal® - BagPipet® - BagPorter® - BagRack® - BagSeal® - Bagsystem® - BagTips® - BagTools® - Biobox® - BioParfum® - BioWaste® - Click and Clean® - Clinet® - Clinet Pick Up® - ColdBox® - CoolMix® - DataLink® - DiluFlow® - Dilute® - Easy Cleaning System ECS® - Easy EZ Bag® - EASY EZ SPIRAL® - Easy Spiral Pro® - EasySpiral® - EasySpiral Dilute® - EnzyClear® - FlexiPump® - Gravimat® - iBag® - iMix® - iNews® - INOXIDOL® - INSTABAG® - INTERBIO® - INTERLAB® - INTERSCIENCE® - iSystem® - iTools® - JumboLine® - JumboMix® - LedCounter® - Malaxeur MaxiMix Blender® - Malaxeur MiniMix® - Microbio® - Microbio Science® - Microbiology World® - MiniPump® - MULTIBAG® - Multilayer® - PetriPile® - PickupBag/BagPickup® - Plate & Count System® - Polyfill® - PolySilk® - Polysil® - Q-Tight® - RollBag® - SaniFood® - SCAN® - ScanProtocol® - ScanStation® - Spiral® - SPIRAL : Ensemenceur Spiral® - SPIRAL : Sembrador Spiral® - SPIRAL : Systeme Spiral® - Spiral Plater® - SteriWater® - STOMAFILTER® - WarmMix®