



Ohio Valley Specialty
C O M P A N Y



Gas Chromatography Supplies
Catalog 62

Get the GC products you need, when you need them.

A trusted source

Ohio Valley has gained a worldwide reputation as being the standard in the industry for our production of a complete line of high quality OV[®] liquid phases. Our fused silica capillary columns are manufactured using genuine OV[®] liquid phases. These columns are capable of performing a wide variety of separations on the most difficult samples and are extremely reproducible, highly efficient, inert, thermally stable and bonded. Each column is thoroughly preconditioned and individually pretested to guarantee high quality.

No worries, no risks

Our products are of the highest quality and fully guaranteed.

Get items quickly

Most orders are shipped within 24 hours.

Get help and information

Our experience in the field of gas chromatography goes back to 1966 with the introduction of OV[®]-1. Our highly dedicated and knowledgeable staff is here to help you with technical support and personal service.



115 Industry Road, Marietta, OH 45750
1-800-729-6872 • (740) 373- 2276 • Fax (740) 373-9910
E-mail: info@ovsc.com • Web: www.ovsc.com





Capillary Columns

4-12

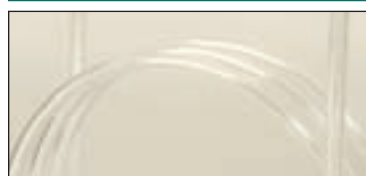

Glass Columns

13-15



Custom-made Packed Columns

16-17



OV[®] Liquid Phases

22-24



Ferrules

32-33



Syringes

38-41



Auto Sampler

49-51



Applications

56-78

Table of Contents

Activated Alumina	30
Adsorbents, Dessicants	30
Applications	56-78
Autosampler Syringes, Agilent	41
Autosampler Vials	49-51
Capillary Maintenance Kit	45
Capillary Connectors	44, 48
Caps, Plastic Column End	46
Chromosorb Century Series	29
Chromosorb Supports	30
Columns, GC Glass	13-15
Columns, GC Metal	16-17, 20
Columns, OV [®] Capillary	4-12
Crimpers	48-49, 54
Decappers	48-49, 54
Diamond Tip Pencil	48
Discs, PTFE/Butyl	53
Discs, PTFE/Rubber	53
Discs, PTFE/Silicone	53-54
Durapak	28
Extractor, Glass Wool	46
Ferrules	32-33
Filter Traps	35
Fittings, Swagelok	31
Fused Silica Tubing	43
Glass Wool	46
Guard Columns	43, 45
Hand-Drill	45
HayeSep	29
Injection Port Liners	42
Molecular Sieves	30
OV [®] Liquid Phases	22-24, 27
Packings, GC	18-19, 21
Porapak, Porasil	28
Porous Polymers	28-29
Purifiers, Gas	35
Racks, Vial Storage	50
Rinsing Reservoir	45
Seals, ColorCoded Autosampler	49, 53
Seals, Crimp-Top Serum Vial	49
Septa 77	36
Septa, GC	37
Siylation Reagents	55
Snap-Lok Autosampler Vials & Accessories	51
SNOOP Leak Detector	46
Stationary Phases	22-27
Stirrers, Magnetic	54
Stoppers	53
Syringes, Hamilton	38-41
Tags, Aluminum Column	46
Tape, PTFE	46
Tenax	29
Tool, Cleaning Kits	47
Traps	35, 42
Tubing	34, 43
Tubing Cutter	34, 46
Tubing Bender	46
Valves, Mininert	54
Vials	49-54

The Fused Silica Tubing

We produce all of our capillary columns from the purist form of glass, namely fused silica. Fused silica capillaries consist of fused silica tubing (SiO_2) and many external coatings of polyimide. It is the polyimide coating that is primarily responsible for the notorious flexibility of the capillary column. Our tubing can withstand temperatures of over 425°C . However, the polyimide coating, along with the upper operating temperature of the liquid phase, is what limits the high temperature end of the capillary column. Before we begin any preparation of the capillary column, all of our tubing goes through a QC test — making sure it meets our high standards. If it does not, we reject it back to the manufacturer. To ensure that we receive only the highest quality tubing, OHIO VALLEY continually selects tubing from several manufacturers. We also work with each of our tubing suppliers to help them improve the quality of their product.



The Deactivated Tubing

Although the tubing that comes from the manufacturers is an excellent grade, it is not suitable for coating stationary phases. We typically use highly advanced deactivation techniques at extreme temperatures to ensure that our GC capillary columns are the most inert possible. Our deactivated tubing is excellent to use as guard columns or retention gap columns. In fact, we pretest every piece of deactivated tubing before we sell it. Our tests yield tubing that is free from defects and exhibits extremely low surface activity. We specially deactivate tubing for the more polar phases, which allows us to better wet polar phases for higher efficiencies and theoretical plates.

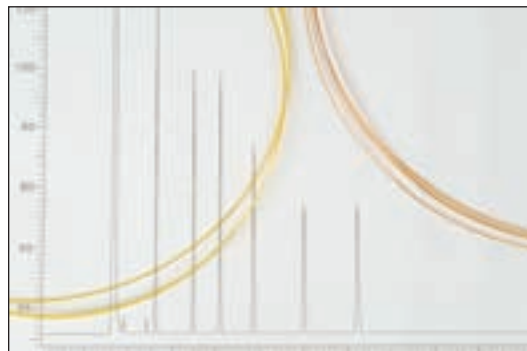

The Stationary Phase

In 1966 we introduced our first liquid phase, the first silicone designed for use as a gas chromatographic stationary phase, OV®-1. Since then we have continued to develop and manufacture, exclusively for gas chromatography, the most complete line of liquid phases available. We have modified our phases with a variation of functional groups to achieve a wide polarity range. All OV® capillary columns ensure very reproducible results with low bleed, high thermal stability, and high theoretical plate counts.



Bonding & Conditioning

Once the column has been coated to the proper film thickness, we chemically bond and cross link the column. All OV® columns are bonded and cross linked. We do not offer non bonded phase columns. We condition each column to achieve excellent thermal stability. The conditioning process is an important part of manufacturing a capillary column. We use conditioning techniques that give excellent thermal stability and allow a long lifetime for the column.

Testing

Each OV® capillary column is tested — individually. We do not batch test columns. We test each column; sometimes we use two or three different test mixes. Our test mixes give an excellent benchmark for rejecting or approving the final column. We continually push our QC department for better columns. Every time we are satisfied with our test results, we continue to make more demands on our columns. Also, we are happy to consider “special testing.” We will run your sample on our column. Please call our technical assistance number (740) 373-2159 for this service.

Custom Manufacturing

Interested in a custom length, ID, Phase, or film thickness? We can manufacture these special columns to fit your individual analysis needs. The price is usually not any more than our stock columns. Delivery times, depending on the column, take between 14 to 20 days. We have a special manufacturing group to deal with custom columns. They will manufacture an excellent quality capillary column — quickly.

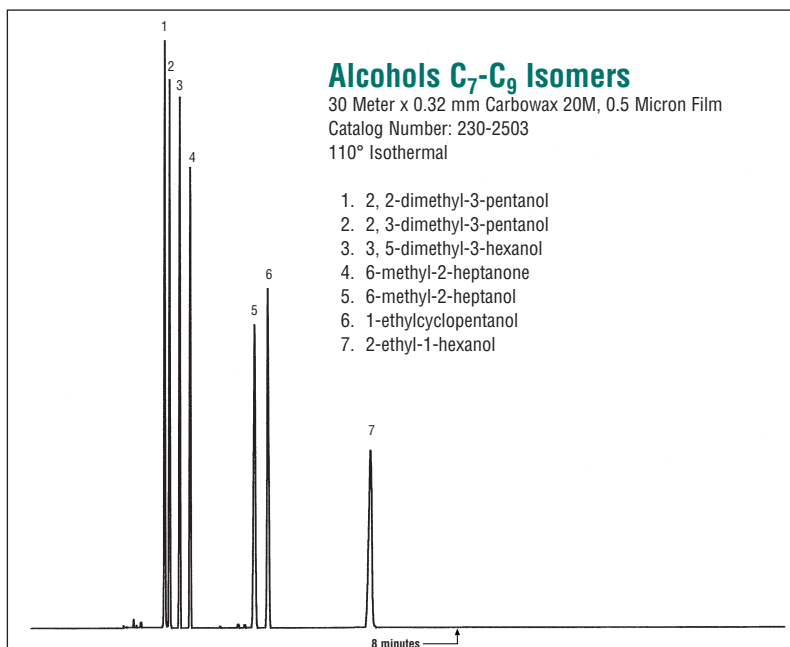
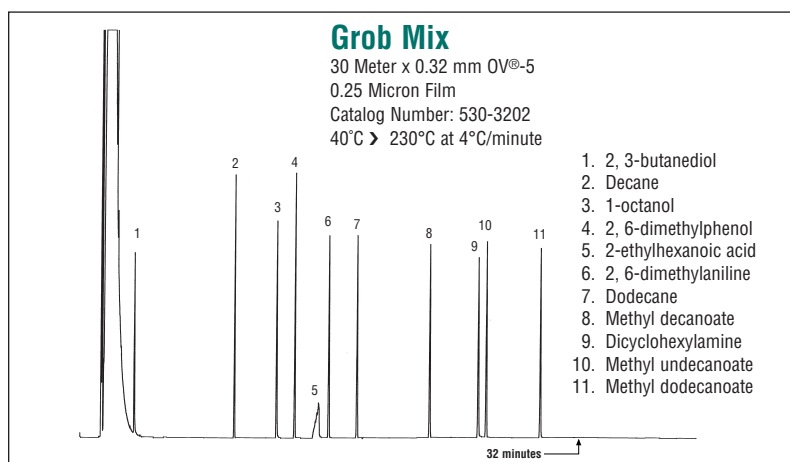
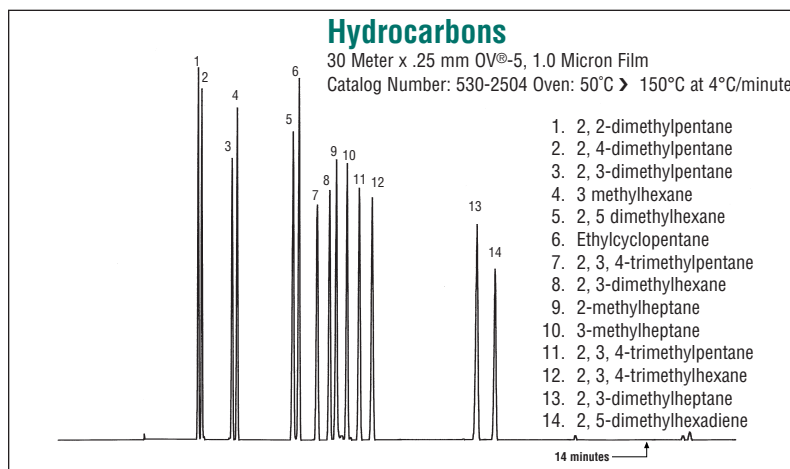

OV[®]-I (100% Dimethylpolysiloxane)

Features

- Non Polar
- Bonded and Crosslinked
- Wide Range of Applications
- High Temperature Range
- Equivalent to USP Phase G2

Applications

- Amines
- PCB's
- Flavors
- Pesticides
- Fragrances
- Phenols
- Hydrocarbons

Similar Phases

- BP-1
- ZB-1
- CP-Sil 5CB
- DB-1
- HP-1
- HP-101
- Rtx-1
- SE-30
- SP-2100
- SPB-1

ID	Film Micron	Temperature Limit (Celsius)	15 Meter	30 Meter	60 Meter	105 Meter
0.25mm	0.10	-60 to 330/350	115-2501	130-2501	160-2501	1105-2501
0.25mm	0.25	-60 to 330/350	115-2502	130-2502	160-2502	1105-2502
0.25mm	0.50	-60 to 330/350	115-2503	130-2503	160-2503	1105-2503
0.25mm	1.00	-60 to 320/340	115-2504	130-2504	160-2504	1105-2504
0.32mm	0.10	-60 to 330/350	115-3201	130-3201	160-3201	1105-3201
0.32mm	0.25	-60 to 330/350	115-3202	130-3202	160-3202	1105-3202
0.32mm	0.50	-60 to 330/350	115-3203	130-3203	160-3203	1105-3203
0.32mm	1.00	-60 to 330/350	115-3204	130-3204	160-3204	1105-3204
0.32mm	1.50	-60 to 320/340	115-3210	130-3210	160-3210	1105-3210
0.32mm	3.00	-60 to 310/330	115-3205	130-3205	160-3205	1105-3205
0.32mm	5.00	-60 to 260/280	115-3206	130-3206		
0.53mm	0.10	-60 to 320/340	115-5301	130-5301	160-5301	
0.53mm	0.25	-60 to 320/340	115-5302	130-5302	160-5302	
0.53mm	0.50	-60 to 310/330	115-5303	130-5303	160-5303	
0.53mm	1.00	-60 to 310/330	115-5304	130-5304	160-5304	
0.53mm	1.50	-60 to 310/330	115-5310	130-5310	160-5310	
0.53mm	3.00	-60 to 270/290	115-5311	130-5311	160-5311	1105-5311
0.53mm	5.00	-60 to 270/290	115-5312	130-5312	160-5312	1105-5312

ID	Film Micron	Temperature Limit (Celsius)	15 Meter	30 Meter	60 Meter
0.45mm	0.13	-60 to 340/360	115-4513		
0.45mm	0.42	-60 to 300/320	115-4542	130-4542	
0.45mm	1.27	-60 to 300/320	115-4527	130-4527	160-4527
0.45mm	2.55	-60 to 270/290	115-4555	130-4555	
0.45mm	4.25	-60 to 270/290	115-4525	130-4525	

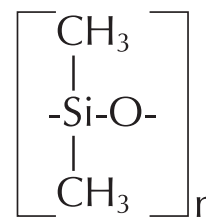

OV[®]-1ms (100% Dimethylpolysiloxane)

ID	Film Micron	Temperature Limit (Celsius)	15 Meter	30 Meter
0.25mm	0.10	-60 to 330/360	115-3901	130-3901
0.25mm	0.25	-60 to 330/360	115-3902	130-3902
0.25mm	0.50	-60 to 330/360	115-3903	130-3903
0.32mm	0.10	-60 to 320/360	115-4601	130-4601
0.32mm	0.25	-60 to 330/360	115-4602	130-4602
0.32mm	0.50	-60 to 330/360	115-4603	130-4603
0.53mm	0.50	-60 to 330/360	115-6703	130-6703

Features

- Identical selectivity to OV[®]-1 (USP G2)
- Very low bleed characteristics
- Bonded and cross-linked
- Non-polar

Custom Columns

If you are looking for a special length, phase, ID, or film thickness not listed in our catalog, please contact our Sales Department at **1-800-729-6872** for a special quote.

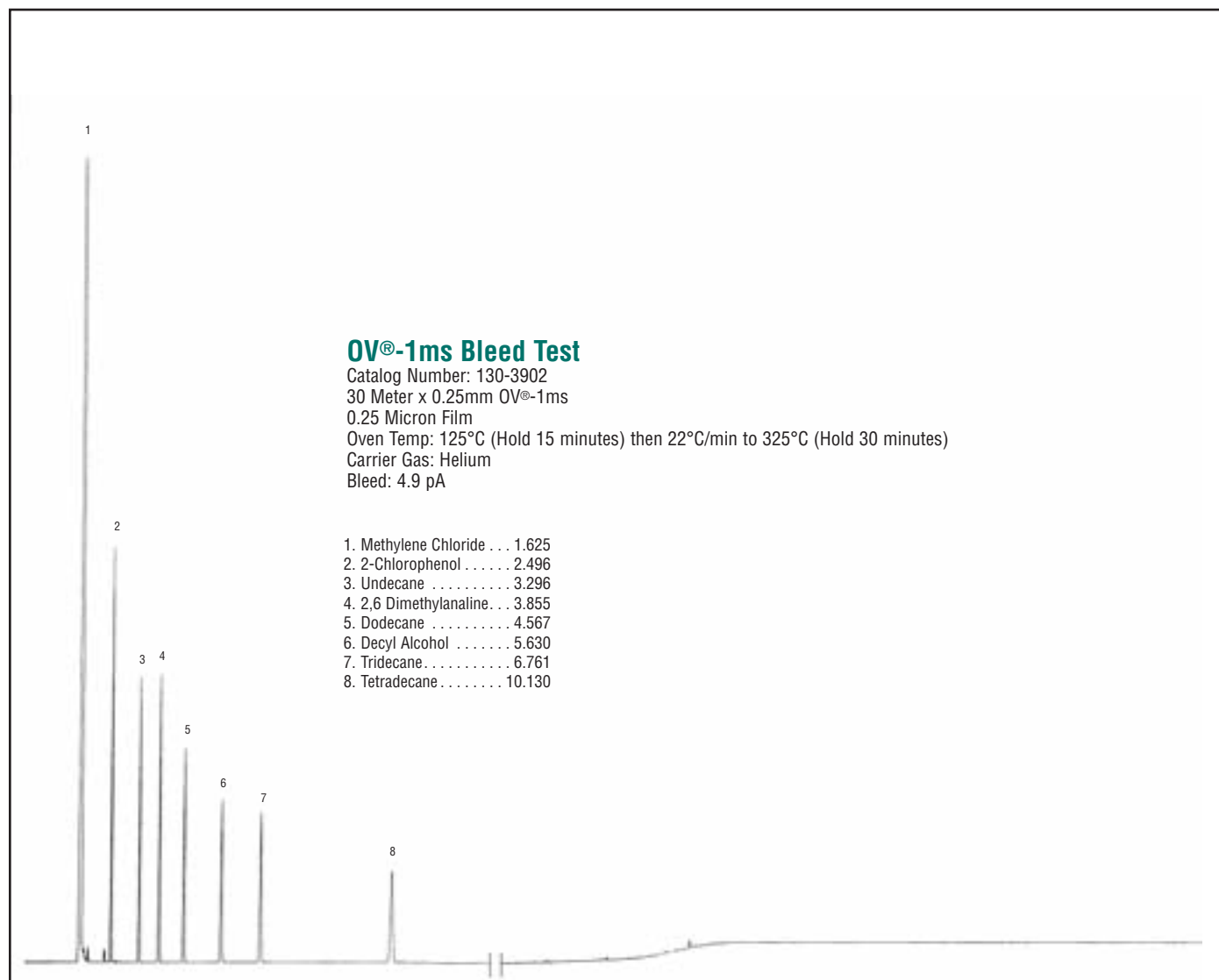

OV[®]-5 (5% Diphenyl, 95% Dimethylpolysiloxane)

Features

- Non Polar
- Bonded and Crosslinked
- High Temperature Range
- Equivalent to USP Phase G27
- General Purpose Column
- Solvent Rinsable

Applications

- Alkaloids
- Aromatics
- Drugs of Abuse
- Fatty Acid Methyl Esters
- Herbicides
- Hydrocarbons
- Halogenated Compounds
- Pesticides

Similar Phases

- BP-5
- ZB-5
- CP-Sil 8CB
- DB-5
- HP-5
- SPB-5
- Rtx-5

ID	Film Micron	Temperature Limit (Celsius)	15 Meter	30 Meter	60 Meter	105 Meter
0.25mm	0.10	-60 to 330/350	515-2501	530-2501	560-2501	5105-2501
0.25mm	0.25	-60 to 330/350	515-2502	530-2502	560-2502	5105-2502
0.25mm	0.50	-60 to 330/350	515-2503	530-2503	560-2503	5105-2503
0.25mm	1.00	-60 to 320/340	515-2504	530-2504	560-2504	5105-2504
0.32mm	0.10	-60 to 330/350	515-3201	530-3201	560-3201	5105-3201
0.32mm	0.25	-60 to 330/350	515-3202	530-3202	560-3202	5105-3202
0.32mm	0.50	-60 to 330/350	515-3203	530-3203	560-3203	5105-3203
0.32mm	1.00	-60 to 330/350	515-3204	530-3204	560-3204	5105-3204
0.32mm	1.50	-60 to 310/330	515-3210	530-3210	560-3210	5105-3210
0.53mm	0.10	-60 to 320/340	515-5301	530-5301	560-5301	
0.53mm	0.25	-60 to 320/340	515-5302	530-5302	560-5302	
0.53mm	0.50	-60 to 320/340	515-5303	530-5303	560-5303	
0.53mm	1.00	-60 to 310/330	515-5304	530-5304	560-5304	
0.53mm	1.50	-60 to 310/330	515-5310	530-5310	560-5310	
0.53mm	3.00	-60 to 270/290	515-5311	530-5311	560-5311	
0.53mm	5.00	-60 to 270/290	515-5312	530-5312	560-5312	5105-5312

ID	Film Micron	Temperature Limit (Celsius)	15 Meter	30 Meter
0.45mm	0.42	-60 to 300/320	515-4542	530-4542
0.45mm	1.27	-60 to 300/320	515-4527	530-4527

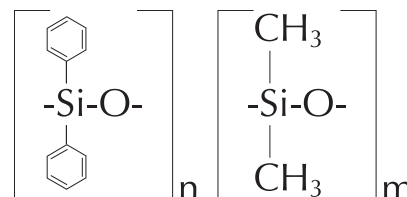

OV[®]-5ms (5% Diphenyl, 95% Dimethylpolysiloxane)

Features

- Exact equivalent to OV[®]-5 (USP G27)
- Very low bleed characteristics
- Bonded and cross-linked
- Non-polar

ID	Film Micron	Temperature Limit (Celsius)	15 Meter	30 Meter
0.25mm	0.10	-60 to 330/360	515-3901	530-3901
0.25mm	0.25	-60 to 330/360	515-3902	530-3902
0.25mm	0.50	-60 to 330/360	515-3903	530-3903
0.32mm	0.10	-60 to 320/360	515-4601	530-4601
0.32mm	0.25	-60 to 330/360	515-4602	530-4602
0.32mm	0.50	-60 to 330/360	515-4603	530-4603
0.53mm	0.50	-60 to 330/360	515-6703	530-6703

Technical Assistance

For those chromatographers who are new to capillary GC or confused about what to order, we recommend that you call OV[®]'s Technical Service Department at (740) 373-2159.

Don't waste your time or money guessing. OV[®] has been doing separation chemistry for over 42 years and has thousands of applications at their disposal. We can recommend the correct column and accessories for your application. A phone call to our technical service department could save you thousands of dollars. Remember, call our Technical Service at (740) 373-2159.

OV[®]-5ms Bleed Test

Catalog Number: 530-4602
30 Meter x 0.32mm OV[®]-5ms
0.25 Micron Film

1. Methylene Chloride 1.97 Min.
2. 2-Chlorophenol 2.893
3. Undecane 3.687
4. 2,6-Dimethylaniline 4.62
5. Dodecane 5.14
6. Decyl Alcohol 6.747
7. Tridecane 7.757
8. Tetradecane 12.463

Oven Temp: 113°C (Hold 15 minutes)
then 10°C/min to 320°C (Hold 30 minutes)

Carrier Gas: Helium

Bleed: 4.3 pA

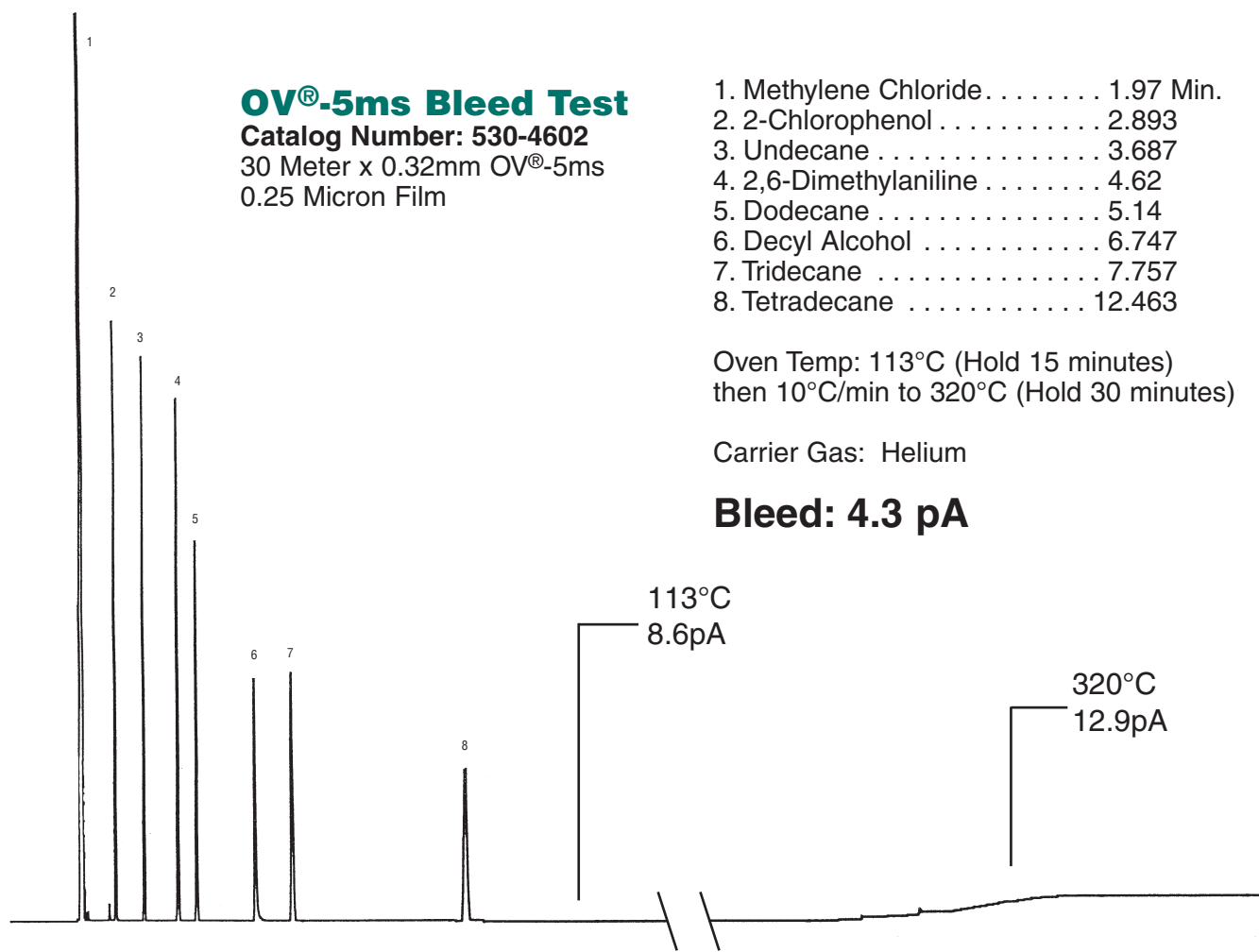

OV[®]-20 (20% Diphenyl, 80% Dimethylpolysiloxane)

Features

- Low to Mid Polarity
- Bonded and Crosslinked
- Solvent Rinsable

Applications

- Alcoholic Beverages
- Flavor Aromatics
- Volatile Compounds

Similar Phases

- DB-20
- Rtx-20
- SPB-20
- VOCOL

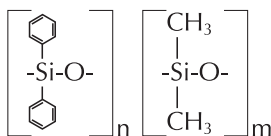

ID	Film Micron	Temperature Limit (Celsius)	15 Meter	30 Meter	60 Meter
0.25mm	0.10	-20 to 300/320	2015-2501	2030-2501	2060-2501
0.25mm	0.25	-20 to 300/320	2015-2502	2030-2502	2060-2502
0.25mm	0.50	-20 to 290/310	2015-2503	2030-2503	2060-2503
0.25mm	1.00	-20 to 280/300	2015-2504	2030-2504	2060-2504
0.32mm	0.10	-20 to 300/320	2015-3201	2030-3201	2060-3201
0.32mm	0.25	-20 to 300/320	2015-3202	2030-3202	2060-3202
0.32mm	0.50	-20 to 290/310	2015-3203	2030-3203	2060-3203
0.32mm	1.00	-20 to 280/300	2015-3204	2030-3204	2060-3204
0.32mm	3.00	-20 to 250/270	2015-3205	2030-3205	2060-3205
0.53mm	0.10	-20 to 260/280	2015-5301	2030-5301	2060-5301
0.53mm	0.25	-20 to 260/280	2015-5302	2030-5302	2060-5302
0.53mm	0.50	-20 to 260/280	2015-5303	2030-5303	2060-5303
0.53mm	1.00	-20 to 260/280	2015-5304	2030-5304	2060-5304
0.53mm	1.50	-20 to 250/270	2015-5310	2030-5310	2060-5310
0.53mm	3.00	-20 to 240/260	2015-5311	2030-5311	2060-5311

OV[®]-35 (35% Diphenyl, 65% Dimethylpolysiloxane)

Features

- Mid Polarity
- Bonded and Crosslinked
- Low Bleed
- Equivalent to USP Phase G42
- Solvent Rinsable

Applications

- Aroclors
- Pesticides
- Pharmaceuticals

Similar Phases

- AT-35
- PE-35
- SPB-35
- Rtx-35
- DB-35
- HP-35

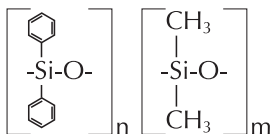

ID	Film Micron	Temperature Limit (Celsius)	15 Meter	30 Meter	60 Meter
0.25mm	0.10	40 to 300/320	3515-2500	3530-2500	3560-2500
0.25mm	0.25	40 to 300/320	3515-2502	3530-2502	3560-2502
0.25mm	0.50	40 to 300/320	3515-2503	3530-2503	3560-2503
0.25mm	1.00	40 to 280/300	3515-2504	3530-2504	3560-2504
0.32mm	0.10	40 to 300/320	3515-3200	3530-3200	3560-3200
0.32mm	0.25	40 to 300/320	3515-3202	3530-3202	3560-3202
0.32mm	0.50	40 to 300/320	3515-3203	3530-3203	3560-3203
0.32mm	1.00	40 to 300/320	3515-3204	3530-3204	3560-3204
0.32mm	1.50	40 to 280/300	3515-3210	3530-3210	3560-3210
0.53mm	0.10	40 to 280/300	3515-5300	3530-5300	3560-5300
0.53mm	0.25	40 to 280/300	3515-5302	3530-5302	3560-5302
0.53mm	0.50	40 to 280/300	3515-5303	3530-5303	3560-5303
0.53mm	1.00	40 to 280/300	3515-5304	3530-5304	3560-5304
0.53mm	1.50	40 to 260/280	3515-5310	3530-5310	3560-5310

ID	Film Micron	Temperature Limit (Celsius)	15 Meter	30 Meter
0.45mm	0.42	40 to 300/320		3530-4542
0.45mm	0.85	40 to 280/300	3515-4585	3530-4585

OV[®]-1301 (6% Cyanopropylphenyl Methylpolysiloxane)

Features

- Low to Mid Polarity
- Bonded and Crosslinked
- Solvent Rinsable
- Equivalent to USP Phase G43

Applications

- Volatile Organics
- Pharmaceutical Samples
- Alcohols
- Oxygenates
- Pesticides
- Aroclors
- PCB's

ID	Film Micron	Temperature Limit (Celsius)	15 Meter	30 Meter	60 Meter
0.25mm	0.10	-20 to 280/300	815-2501	830-2501	860-2501
0.25mm	0.25	-20 to 280/300	815-2502	830-2502	860-2502
0.25mm	0.50	-20 to 280/300	815-2503	830-2503	860-2503
0.25mm	1.00	-20 to 280/300	815-2504	830-2504	860-2504
0.32mm	0.10	-20 to 280/300	815-3201	830-3201	860-3201
0.32mm	0.25	-20 to 280/300	815-3202	830-3202	860-3202
0.32mm	0.50	-20 to 280/300	815-3203	830-3203	860-3203
0.32mm	1.00	-20 to 280/300	815-3204	830-3204	860-3204
0.53mm	0.10	-20 to 260/280	815-5301	830-5301	860-5301
0.53mm	0.25	-20 to 260/280	815-5302	830-5302	860-5302
0.53mm	0.50	-20 to 260/280	815-5303	830-5303	860-5303
0.53mm	1.00	-20 to 260/280	815-5304	830-5304	860-5304
0.53mm	1.50	-20 to 260/280	815-5310	830-5310	860-5310
0.53mm	3.00	-20 to 260/280	815-5311	830-5311	860-5311

Similar Phases

- DB-1301
- HP-1301
- PE-1301
- Rtx-1301

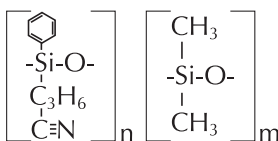

OV[®]-1701 (14% Cyanopropylphenyl Methylpolysiloxane)

Applications

- Pharmaceutical Samples
- Alcohols
- Oxygenates
- Pesticides
- Aroclors
- PCBs
- Solvents

Similar Phases

- BP-10
- CB-1701
- CP-Sil 19CB
- DB-1701
- Rtx-1701

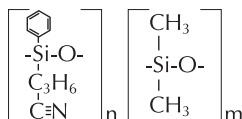

ID	Film Micron	Temperature Limit (Celsius)	15 Meter	30 Meter	60 Meter
0.25mm	0.10	-20 to 280/300	415-2500	430-2500	460-2500
0.25mm	0.15	-20 to 280/300	415-2501	430-2501	460-2501
0.25mm	0.25	-20 to 280/300	415-2502	430-2502	460-2502
0.25mm	0.50	-20 to 280/300	415-2503	430-2503	460-2503
0.25mm	1.00	-20 to 280/300	415-2504	430-2504	
0.32mm	0.10	-20 to 280/300	415-3200	430-3200	460-3200
0.32mm	0.15	-20 to 280/300	415-3201	430-3201	
0.32mm	0.25	-20 to 280/300	415-3202	430-3202	460-3202
0.32mm	0.50	-20 to 280/300	415-3203	430-3203	460-3203
0.32mm	1.00	-20 to 280/300	415-3204	430-3204	460-3204
0.53mm	0.10	-20 to 260/280	415-5300	430-5300	460-5300
0.53mm	0.25	-20 to 260/280	415-5302	430-5302	460-5302
0.53mm	0.50	-20 to 260/280	415-5303	430-5303	460-5303
0.53mm	1.00	-20 to 260/280	415-5310	430-5310	460-5310
0.53mm	1.50	-20 to 260/280	415-5311	430-5311	460-5311

OV[®]-225 (50% Cyanopropylmethyl, 50% Phenylmethylpolysiloxane)

Features

- Mid/High Polarity
- Bonded and Crosslinked
- Solvent Rinsable
- Equivalent to USP G7
- Low Bleed

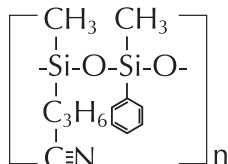

ID	Film Micron	Temperature Limit (Celsius)	15 Meter	30 Meter
0.25mm	0.10	40 to 220/240	715-2500	730-2500
0.25mm	0.15	40 to 220/240	715-2501	730-2501
0.25mm	0.25	40 to 220/240	715-2502	730-2502
0.25mm	0.50	40 to 220/240	715-2503	730-2503
0.32mm	0.10	40 to 220/240	715-3200	730-3200
0.32mm	0.15	40 to 220/240	715-3201	730-3201
0.32mm	0.25	40 to 220/240	715-3202	730-3202
0.32mm	0.50	40 to 220/240	715-3203	730-3203
0.53mm	0.10	40 to 200/220	715-5300	730-5300
0.53mm	0.25	40 to 200/220	715-5302	730-5302
0.53mm	0.50	40 to 200/220	715-5303	730-5303
0.53mm	1.00	40 to 200/220	715-5310	730-5310

Applications

- Fatty Acid Methyl Esters (FAME)
- PUFA
- Alditol
- Neutral Sterols

Similar Phases

- 007-225
- BP-225
- CP-Sil 43CB
- DB-225
- HP-225
- Rtx-225

ID	Film Micron	Temperature Limit (Celsius)	15 Meter	30 Meter
0.45mm	0.85	40 to 200/220	715-4585	730-4585

OV[®]-624 Designed for the Analysis of Priority Pollutants

Features

- Bonded and Crosslinked
- Solvent Rinsable

Applications

- EPA Method 502.2 Volatile Organics

Similar Phases

- 007-624
- AT-624
- CP-624
- DB-624
- HP-624
- RTX-Volatiles
- Rtx-502.2
- VOCOL

ID	Film Micron	Temperature Limit (Celsius)	30 Meter	60 Meter
0.25mm	1.4	-20 to 260	630-2514	660-2514
0.32mm	1.8	-20 to 260	630-3207	660-3207
0.53mm	3.0	-20 to 260	630-5307	

ID	Film Micron	Temperature Limit (Celsius)	30 Meter
0.45mm	2.55	-20 to 260	630-4525

Carbowax 20M Polyethylene Glycol (PEG)

Features

- High Polarity
- Bonded and Crosslinked
- Solvent Rinsable
- Equivalent to USP G16

Applications

- Alcohols
- Aromatics
- Essential Oils
- Glycols
- Polar Solvents

Similar Phases

- CP-Wax
- DB-Wax
- HP-Innowax
- PE-Wax
- Rtx-Wax

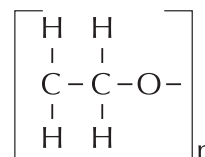

ID	Film Micron	Temperature Limit (Celsius)	15 Meter	30 Meter	60 Meter
0.25mm	0.10	20 to 250/260	215-2500	230-2500	260-2500
0.25mm	0.15	20 to 250/260	215-2501	230-2501	260-2501
0.25mm	0.25	20 to 250/260	215-2502	230-2502	260-2502
0.25mm	0.50	20 to 250/260	215-2503	230-2503	260-2503
0.25mm	1.00	20 to 250/260	215-2504	230-2504	260-2504
0.32mm	0.10	20 to 250/260	215-3200	230-3200	260-3200
0.32mm	0.15	20 to 250/260	215-3201	230-3201	260-3201
0.32mm	0.25	20 to 250/260	215-3202	230-3202	260-3202
0.32mm	0.50	20 to 240/250	215-3203	230-3203	260-3203
0.32mm	1.00	20 to 230/240	215-3204	230-3204	260-3204
0.53mm	0.25	20 to 230/240	215-5302	230-5302	260-5302
0.53mm	0.50	20 to 230/240	215-5303	230-5303	260-5303
0.53mm	1.00	20 to 230/240	215-5310	230-5310	260-5310

OV[®]-35 I Nitroterephthalic Acid Modified PEG

Features

- High Polarity
- Bonded and Crosslinked
- Solvent Rinsable
- Equivalent to USP G35

Applications

- Underivatized Free Fatty Acids

Similar Phases

- BP-21
- FFAP
- CP-FFAP
- DB-FFAP
- HP-FFAP
- PE-FFAP
- Nukol

ID	Film Micron	Temperature Limit (Celsius)	15 Meter	30 Meter	60 Meter
0.25mm	0.10	40 to 250	315-2501	330-2501	360-2501
0.25mm	0.25	40 to 250	315-2502	330-2502	360-2502
0.25mm	0.50	40 to 250	315-2503	330-2503	360-2503
0.32mm	0.10	40 to 250	315-3201	330-3201	360-3201
0.32mm	0.25	40 to 250	315-3202	330-3202	360-3202
0.32mm	0.50	40 to 250	315-3203	330-3203	360-3203
0.32mm	1.00	40 to 250	315-3204	330-3204	360-3204
0.53mm	0.10	40 to 250	315-5301	330-5301	360-5301
0.53mm	0.25	40 to 250	315-5302	330-5302	360-5302
0.53mm	0.50	40 to 250	315-5303	330-5303	360-5303
0.53mm	1.00	40 to 250	315-5310	330-5310	360-5310
0.53mm	1.50	40 to 250	315-5311	330-5311	360-5311

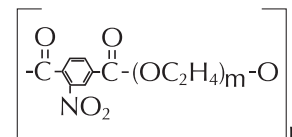



OV[®]-17 (50% Diphenyl, 50% Dimethylpolysiloxane)

Features

- Midpolarity Phase
- 50% Diphenyl, 50% Dimethylpolysiloxane
- Bonded and Crosslinked
- Solvent Rinsable
- Equivalent to USP-G3

Applications

- Herbicides
- Steroids
- Drug Screening

Similar Phases

- DB-17
- HP-17
- HP-50
- Rtx-50
- AT-50
- ZB-50
- SPB-50
- CP-Sil 24
- SP-2250

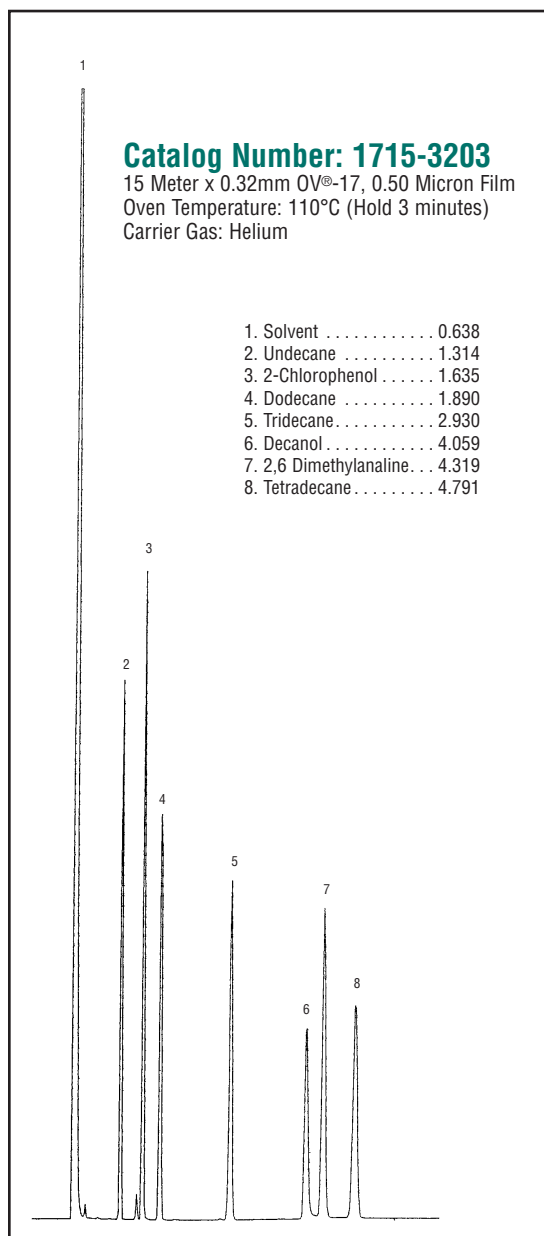

ID	Film Micron	Temperature Limit (Celsius)	15 Meter	30 Meter
0.25 mm	0.15	0 to 300/320	1715-2500	1730-2500
0.25 mm	0.25	0 to 300/320	1715-2502	1730-2502
0.25 mm	0.50	0 to 290/310	1715-2503	1730-2503
0.32 mm	0.15	0 to 300/320	1715-3200	1730-3200
0.32 mm	0.25	0 to 300/320	1715-3202	1730-3202
0.32 mm	0.50	0 to 290/310	1715-3203	1730-3203
0.32 mm	1.00	0 to 280/300	1715-3204	1730-3204
0.53 mm	0.50	0 to 270/290	1715-5303	1730-5303
0.53 mm	1.00	0 to 260/280	1715-5304	1730-5304

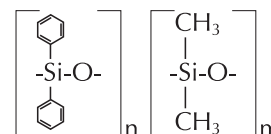

Glass Columns (All Glass Columns are Silane Treated)

To simplify ordering a packed column use the empty column catalog number and describe the packing.

Unless otherwise specified, all columns are ¼" O.D. borosilicate glass and silane treated.

All packed columns are supplied with ¼" brass swagelok nuts and high temperature flexible graphite ferrules.

- Stock — immediate shipment.
- Each column packaged in individual boxes for easy and safe storage.
- One piece construction (lengths 6 feet & under)
- Made to exact tolerances. Constant I.D. and length insure reproducible chromatograms from column to column.
- DMCS silane treated.
- Packed columns supplied with high temperature graphite ferrules.

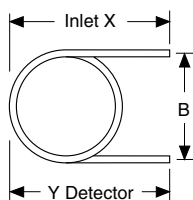

Key to Dimensions for Glass Columns
Measure "B"
(center to center)

At right you will find the "Key to Dimensions for Glass Columns." Please make measurements on the column you are replacing and choose a comparably sized column from the table.

Special Surcharges Apply For:

Carbopack/Graphpac
Chromosorb Century Series
Deactigel
Dexsil packing
Durapaks, Ultrabond
Granular Carbon Mole Sieves
OV®-275, OV®-330, OV®-1701, packing
Pennwalt Amine packing
Poly, Poly MPE, Polyser
Porapaks, Porasils, HayeSep
Silar packings
Tenax
Double Coated packings
Stainless Steel nuts
Graphite/Polyimide Ferrules
Preconditioning

Precise column length and precise I.D. guarantees improved reproducibility

Variation in column length and I.D. can cause substantial variation in retention times for the same analysis. Different instrument manufacturer specifications for a typical 6 foot column may actually yield a column length that is longer or shorter than 6 feet. In addition, I.D. tolerances for glass tubing may also vary from lot to lot and from one manufacturer to

another. Metric Columns are a solution to this problem. Produced to a precise column length ($\pm 1.5\%$) with an I.D. variation of ($\pm 0.0025''$) for 2 mm I.D. and ($\pm .005''$) for 4 mm I.D. columns, these columns are guaranteed to improve column to column reproducibility.

Configuration	X Y B	Instrument	Dimensions			Catalog Number
			L	O.D.	I.D.	
	X=11.02"	Agilent, Hewlett-Packard 5880, 5890, 5987, 6890, Configuration "A"	2'	¼"	2mm	220-022
			2'	¼"	4mm	220-024
	Y=9.05"		4'	¼"	4mm	220-044
			6'	¼"	2mm	220-062
			6'	¼"	4mm	220-064
			8'	¼"	2mm	220-082
			10'	¼"	2mm	220-102
			2.0m	¼"	2mm	220-2M2
	B=9"		2.0m	¼"	4mm	220-2M4
			2.4m	¼"	2mm	220-2.4M2
	X=11.02"	Agilent, Hewlett-Packard 5880 Configuration "B" TCD only	2'	¼"	2mm	221-022
			6'	¼"	2mm	221-062
	Y=7.09"		6'	¼"	4mm	221-064
			B=9"			

* For column lengths that are not listed refer to page 15, Custom-made Glass Columns

— continued

Glass Columns (All Glass Columns are Silane Treated)

Configuration	X Y B	Instrument	Dimensions			Catalog Number
			L	O.D.	I.D.	
	X=8 $\frac{5}{8}$ " Y=8 $\frac{5}{8}$ " B=8 $\frac{3}{4}$ "	Perkin-Elmer 115, 900, 990, F-30, 2000, 2100, 3920, Sigma Series Not On-Column Injection	2'	$\frac{1}{4}$ "	2mm	222-022
			3'	$\frac{1}{4}$ "	2mm	222-032
			3'	$\frac{1}{4}$ "	4mm	222-034
			6'	$\frac{1}{4}$ "	2mm	222-062
			6'	$\frac{1}{4}$ "	4mm	222-064
			8'	$\frac{1}{4}$ "	2mm	222-082
10'	$\frac{1}{4}$ "	2mm	222-102			
2.0m	$\frac{1}{4}$ "	2mm	222-2M2			
2.0m	$\frac{1}{4}$ "	4mm	222-2M4			
	X=12 $\frac{5}{8}$ " Y=7 $\frac{1}{8}$ " B=8 $\frac{3}{4}$ "	Perkin-Elmer Sigma Series Heated On-Column Injection Position "A" Only	3'	$\frac{1}{4}$ "	2mm	223-032
			6'	$\frac{1}{4}$ "	2mm	223-062
			6'	$\frac{1}{4}$ "	4mm	223-064
			2.0m	$\frac{1}{4}$ "	2mm	223-2M2
			2.0m	$\frac{1}{4}$ "	4mm	223-2M4
2.4m	$\frac{1}{4}$ "	2mm	223-2.4M2			
	X=6 $\frac{13}{16}$ " Y=6 $\frac{13}{16}$ " B=6 $\frac{1}{2}$ "	Perkin-Elmer 8300, 8400, 8500, 8600, 8700 Series, Autosystem Not On-Column Injection	6'	$\frac{1}{4}$ "	2mm	226-062
			6'	$\frac{1}{4}$ "	4mm	226-064
			10'	$\frac{1}{4}$ "	2mm	226-102
			10'	$\frac{1}{4}$ "	4mm	226-104
			2.0m	$\frac{1}{4}$ "	2mm	226-2M2
2.0m	$\frac{1}{4}$ "	4mm	226-2M4			
	X=12" Y=6 $\frac{3}{16}$ " B=6 $\frac{1}{2}$ "	Perkin-Elmer Autosystem 8300, 8400, 8500, 8600, 8700 Series On-Column Injection	6'	$\frac{1}{4}$ "	2mm	227-062
			6'	$\frac{1}{4}$ "	4mm	227-064
			10'	$\frac{1}{4}$ "	2mm	227-102
			10'	$\frac{1}{4}$ "	4mm	227-104
			2.0m	$\frac{1}{4}$ "	2mm	227-2M2
2.0m	$\frac{1}{4}$ "	4mm	227-2M4			
	X=355mm Y=282mm B=40mm	Shimadzu GC-4BM, 4CM, 4MG, GC-6A, 6AM, GC-7AG, 7A, 9A, GC-R1A, 14A, 15A, 16A	1.7m	5mm	3mm	284-1.7M3
			2.5m	5mm	3mm	284-2.5M3
	X=190mm Y=142mm B=120mm	Shimadzu Mini-GC	3'	5mm	3mm	285-033
			6'	5mm	3mm	285-063
	X=229mm Y=229mm B=152mm	Shimadzu GC-8A 81F	1.5m	5mm	3mm	286-1.5M3
			2.0m	5mm	3mm	286-2.0M3
			3.0m	5mm	3mm	286-3.0M3
	X=8" Y=8" B=6"	Tracor 540, 560, 565, 570	3'	$\frac{1}{4}$ "	2mm	233-032
			6'	$\frac{1}{4}$ "	2mm	233-062
			6'	$\frac{1}{4}$ "	4mm	233-064
			8'	$\frac{1}{4}$ "	2mm	233-082
			10'	$\frac{1}{4}$ "	2mm	233-102
			2.0m	$\frac{1}{4}$ "	2mm	233-2M2
			2.0m	$\frac{1}{4}$ "	4mm	233-2M4
			2.4m	$\frac{1}{4}$ "	2mm	233-2.4M2

* For column lengths that are not listed refer to page 15, Custom-made Glass Columns

At right you will find the "Key to Dimensions for Glass Columns." Please make measurements on the column you are replacing and choose a comparably sized column from the table.

**Key to Dimensions
for Glass Columns**
Measure "B"
(center to center)

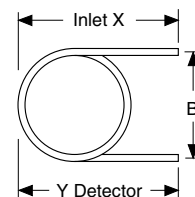

Glass Columns (All Glass Columns are Silane Treated)

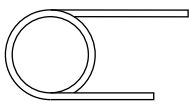
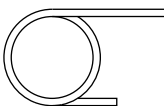
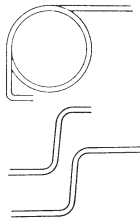
Configuration	X Y B	Instrument	Dimensions			Catalog Number
			L	O.D.	I.D.	
	X=9 $\frac{9}{16}$ " Y=8" B=5 $\frac{1}{2}$ "	Varian 3700, 4400, 4600, 6000 Vista Series FID, ECD, TSD	2'	$\frac{1}{4}$ "	2mm	248-022
			3'	$\frac{1}{4}$ "	2mm	248-032
			3'	$\frac{1}{4}$ "	4mm	248-034
			4'	$\frac{1}{4}$ "	2mm	248-042
			6'	$\frac{1}{4}$ "	2mm	248-062
			6'	$\frac{1}{4}$ "	4mm	248-064
			8'	$\frac{1}{4}$ "	2mm	248-082
			10'	$\frac{1}{4}$ "	2mm	248-102
			10'	$\frac{1}{4}$ "	4mm	248-104
			2.0m	$\frac{1}{4}$ "	2mm	248-2M2
			2.0m	$\frac{1}{4}$ "	4mm	248-2M4
			2.4m	$\frac{1}{4}$ "	2mm	248-2.4M2
	X=9 $\frac{1}{2}$ " Y=5 $\frac{1}{2}$ " B=5 $\frac{1}{2}$ "	Varian 3800	6'	$\frac{1}{4}$ "	2mm	250-062
			6'	$\frac{1}{4}$ "	4mm	250-064
	X=9 $\frac{1}{4}$ " Y=5 $\frac{7}{8}$ " B=9"	Varian Universal 3000, 3300, 3400, 3600, 3700, 4400, 4600, 6000, Vista Series	6'	$\frac{1}{4}$ "	2mm	252-062
			6'	$\frac{1}{4}$ "	4mm	252-064
		Two adapters, one long and one short, are supplied with the column. A special bored-through union is required to join the column and the adapter. This union is not supplied with the column. For this union, order part number B-6BT (each).				

* For column lengths that are not listed refer to Custom-made Glass Columns below.

At right you will find the "Key to Dimensions for Glass Columns." Please make measurements on the column you are replacing and choose a comparably sized column from the table.

Key to Dimensions for Glass Columns
Measure "B"
(center to center)

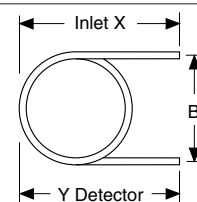

Custom-made Glass Columns

If you cannot find the column you need listed in our Glass Column section (pages 13-15), please call our Sales Department at 1-800-729-6872.

Custom-made Packed Columns

Stainless Steel, Copper, Aluminum, Nickel and PTFE

Our custom-made OV[®]-Packed columns carry a 100% Satisfaction Guarantee!

Orders for custom-made columns will be given immediate attention and most will be shipped within 24 hours from receipt of order. We can supply packed columns made with any combination of support and liquid phase listed in this catalog. We will also make every effort to supply your requirements for other supports or liquid phases.

- Over 42 years experience in packing preparation and column techniques.
- 24 hour delivery.
- Complete with brass Swagelok fittings.
- All stainless steel tubing is our premium grade, manufactured for GC use only.
- Each column packed in individual container. (No lost ferrules or end caps)
- OV's guide to packings and columns included.

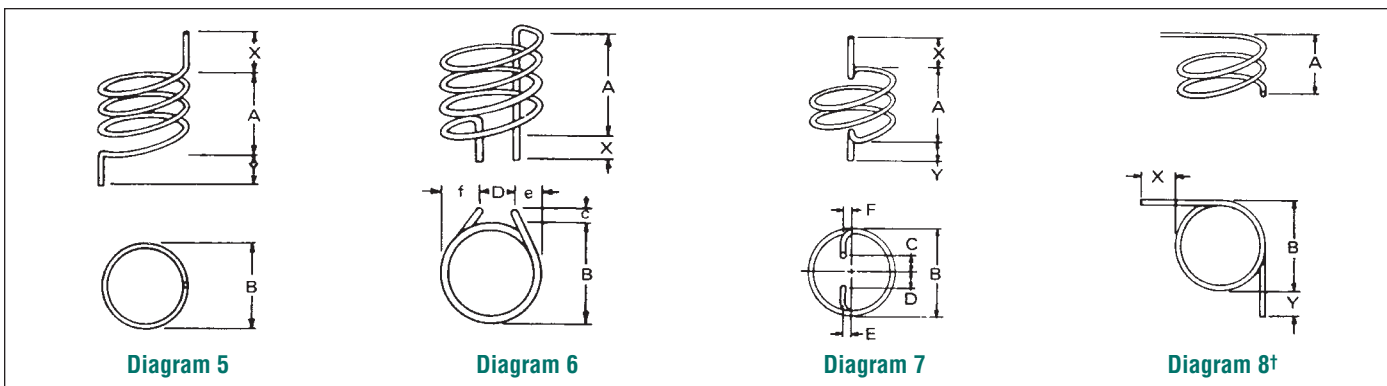
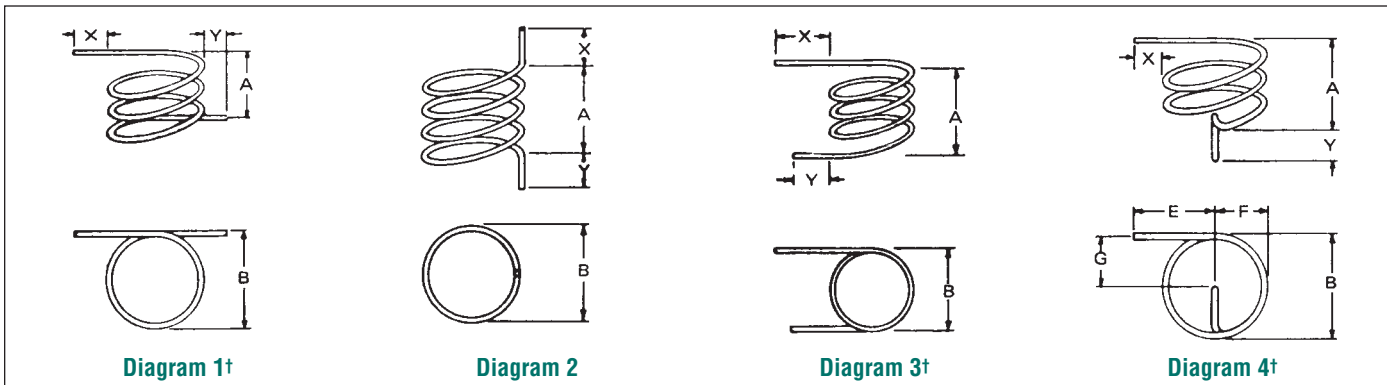

†Beware of mirror image. Specify mirror image if necessary.

Request A Quote Example:

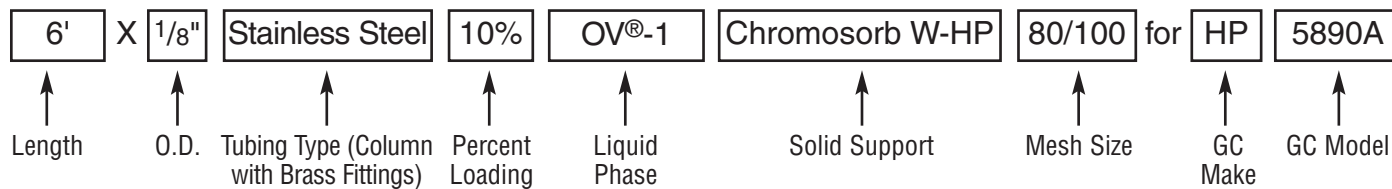

**Request A Quote:
Stainless Steel, Copper, Aluminum, Nickel and PTFE Columns**

Complete your information below and fax to (740) 373-9910. We will send you a firm quote.

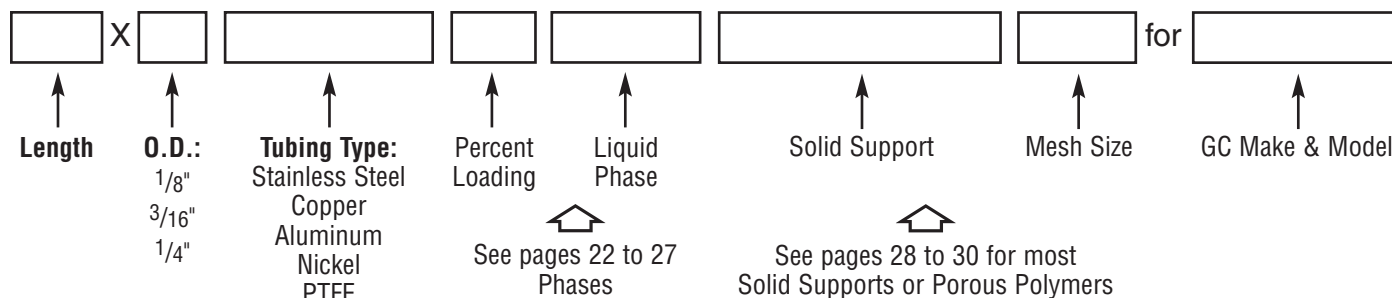

Brass Fittings (standard) Stainless Steel Fittings

Preconditioned

If necessary, reference drawing on page 16.

Company _____ Contact name _____

Address _____

City _____ State _____ Zip _____

Phone _____ Fax _____ e-mail _____

Custom Prepared Packings (Shipped within 24 hours)

Chart Listing Equivalent Supports

Manufacturer	Non-Acid Washed	Acid Washed	Acid Washed DMCS Treated	Acid Washed DMCS Treated High Performance
Analabs		Anakrom A	Anakrom AS	Anakrom Q
Alltech	Gas Chrom S Gas Chrom R	Gas Chrom A Gas Chrom RA	Gas Chrom Z Gas Chrom RZ	Gas Chrom Q
Celite	Chromosorb W-NAW Chromosorb G-NAW	Chromosorb W-AW Chromosorb G-AW	Chromosorb W-AW DMCS Chromosorb G-AW DMCS	Chromosorb W-HP Chromosorb G-HP
Supelco				Supelcoport

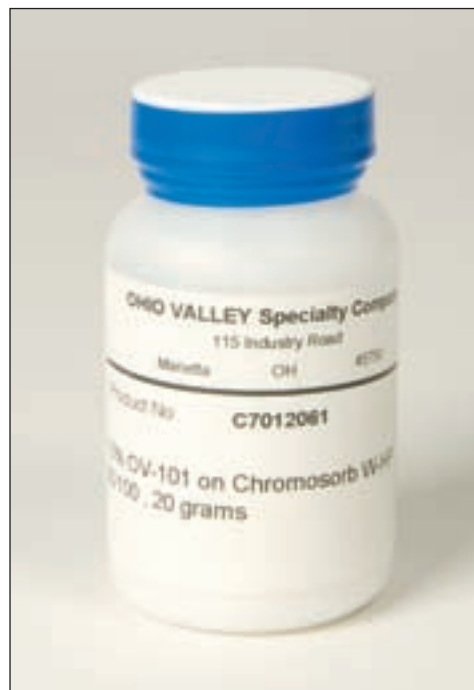
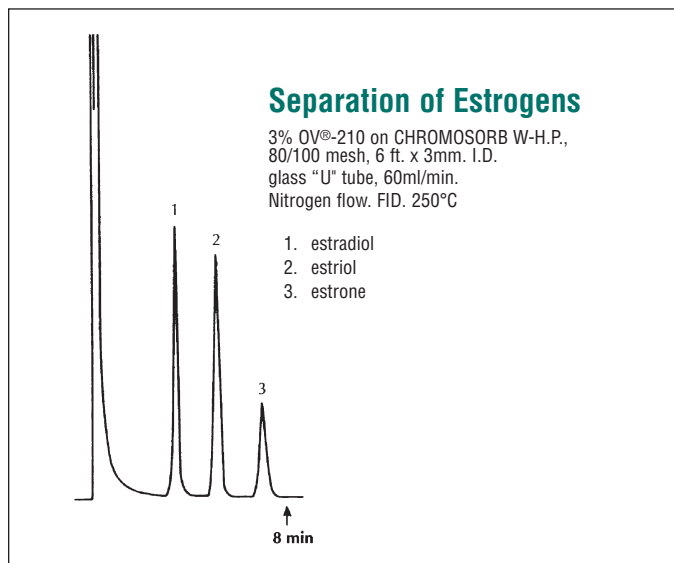

Custom Prepared Packings (Shipped within 24 Hours)

Support	Mesh	Phase	% Loading	Quantity
Anakrom A	80/100,100/120	Any Phase	Any % Loading	20gm or
Anakrom AS, Q	80/100,100/120			
Chromosorb W-HP	60/80, 80/100,100/120,120/140	See pages 22 to 27 for a list of phases		50gm or 100gm
Chromosorb G-HP	60/80, 80/100,100/120			
Chromosorb 750	60/80, 80/100,100/120			
Chromosorb 101, 102, 103, 104, 105, 106, 107, 108	60/80, 80/100,100/120			
Chromosorb P(NAW), (AW)	60/80, 80/100,100/120			
Chromosorb G(NAW), (AW)	60/80, 80/100,100/120			
Chromosorb W(NAW), (AW)	60/80, 80/100,100/120			
Chromosorb P(HMDS), (AW-DMCS)	60/80, 80/100,100/120			
Chromosorb G(AW-DMCS)	60/80, 80/100,100/120			
Chromosorb W(HMDS), (AW-DMCS)	60/80, 80/100,100/120			
Chromosorb T	30/60, 40/60			
Gas Chrom Q	60/80, 80/100,100/120,120/140			
Gas Chrom P, Z, A, RA, RZ	60/80, 80/100,100/120			
Glass Beads (Regular)*	60/80, 80/100,100/120			
Porapaks, HayeSep	50/80, 80/100, 100/120			

Example

Solid Support	Mesh Size	Liquid Phase	% Loading	Quantity
Chromosorb W-NAW	60/80	OV®-101	3%	20 grams

Request a Quote: Complete your info and fax to (740) 373-9910

Solid Support	Mesh Size	Liquid Phase	% Loading	Quantity
<input type="text"/>	<input type="text"/>	<input type="text"/>	<input type="text"/>	<input type="text"/>

Special →

Company _____ Contact Name _____

Address _____

City _____ State _____ Zip _____

Phone _____ Fax _____ e-mail _____

Stock GC Columns Packed 6' x 1/8" Stainless Steel Columns Supplied with Brass fittings

- Shipped from stock
- Guaranteed: Supplied with our guide to packings & columns
- 42 years experience in packing columns
- Stainless steel tubing used is our premium grade, manufactured for GC use

Description (Each)	Catalog Number
10% Apiezon L on Chromosorb W-HP 80/100	600
10% Carbowax 400 on Chromosorb W-HP 80/100	602
10% Carbowax 1500 on Chromosorb W-HP 80/100	604
10% Carbowax 20M on Chromosorb W-HP 80/100	606
10% Carbowax 20M on Chromosorb W-AW 80/100	607
10% Carbowax 20M-TPA on Chromosorb W-AW 80/100	608
Chromosorb 101, 80/100	610
Chromosorb 102, 80/100	612
Chromosorb 103, 80/100	614
Chromosorb 105, 80/100	618
Chromosorb 106, 80/100	620
Chromosorb 107, 80/100	622
Chromosorb 108, 80/100	624
10% DEGS on Chromosorb W-AW 80/100	626
15% DEGS on Chromosorb W-AW 80/100	628
5% FFAP on Chromosorb W-HP 80/100	630
5% FFAP on Chromosorb W-AW 80/100	632
3% OV®-1 on Chromosorb W-HP 80/100	634
3% OV®-1 on Chromosorb W-HP 100/120	636
10% OV®-1 on Chromosorb W-HP 80/100	638
3% OV®-17 on Chromosorb W-HP 80/100	640
3% OV®-17 on Chromosorb W-HP 100/120	642
10% OV®-17 on Chromosorb W-HP 80/100	646
10% OV®-17 on Chromosorb W-HP 100/120	648

Description (Each)	Catalog Number
3% OV®-101 on Chromosorb W-HP 80/100	650
3% OV®-101 on Chromosorb W-HP 100/120	652
10% OV®-101 on Chromosorb W-HP 80/100	654
3% OV®-210 on Chromosorb W-HP 80/100	656
3% OV®-225 on Chromosorb W-HP 100/120	658
3% OV®-225 on Chromosorb W-HP 80/100	659
10% OV®-225 on Chromosorb W-HP 80/100	684
3% OV®-275 on Chromosorb W-AW 80/100	660
3% SE-30 GC Grade on Chromosorb W-HP 80/100	661
Porapak Q 80/100	662
Porapak P 80/100	664
Porapak R 80/100	666
Porapak S 80/100	668
Porapak T 80/100	670
Porapak T 100/120	672
Porapak N 80/100	674
Porapak QS 80/100	676
Porapak PS 80/100	678
1.5% OV®-17 + 1.95% QF-1 on Chromosorb W-HP 80/100	680
4% SE-30 + 6% OV®-210 on Chromosorb W-HP 80/100	682

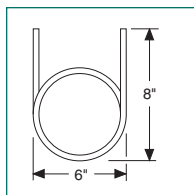

This is a general configuration. The 1/8" tubing can be carefully formed to fit your GC.

Ohio Valley is one of the world's leading specialists in the manufacturing of high quality, dependable packed columns. For any questions concerning custom made packed columns please feel free to call **(740) 373-2276**, fax **(740)373-9910** or e-mail **info@ovsc.com**.

Custom Packed Metal and PTFE ColumnsPages 16-17
 Custom Packed Glass ColumnsPages 13-15

Stock Packings









- Immediate shipment from stock
- Guaranteed
- Highest Possible Quality
- 20 grams (unless otherwise specified)

Catalog Number	Description	°C Min/Max	Use**
8111	OV®-1 1% Chromosorb W-HP 80/100	100/350	General
8113	OV®-1 3% Chromosorb W-HP 80/100	100/350	General
8114	OV®-1 3% Gas Chrom Q 80/100*	100/350	General
8115	OV®-1 3% Chromosorb W-HP 100/120	100/350	General
8116	OV®-1 3% Gas Chrom Q 100/120*	100/350	General
8133	OV®-17 3% Chromosorb W-H P 80/100	20/350	
8134	OV®-17 3% Gas Chrom Q 80/100*	20/350	General
8136	OV®-17 3% Gas Chrom Q 100/120*	20/350	Hydrocarbons
8139	OV®-17 3% Chromosorb W-AW DMCS 100/120	20/350	Drugs Analysis
8140	OV®-17 10% Chromosorb W-HP 100/120	20/350	Pesticides
8151	OV®-25 3% Chromosorb W-HP 80/100	20/300	
8171	OV®-101 1% Chromosorb W-HP 80/100	20/350	General
8173	OV®-101 3% Chromosorb W-HP 80/100	20/350	Hydrocarbons
8172	OV®-101 3% Gas Chrom Q 80/100*	20/350	Carbohydrates
8174	OV®-101 3% Chromosorb W-HP 100/120	20/350	FAME
8175	OV®-101 10% Chromosorb W-HP 80/100	20/350	Alcohols
8176	OV®-101 10% Chromosorb W-HP 100/120	20/350	
8183	OV®-210 3% Chromosorb W-HP 80/100	20/275	General
8142	OV®-210 10% Chromosorb W-HP 80/100	20/275	General
8191	OV®-225 3% Chromosorb W-HP 80/100	20/250	General
8194	OV®-225 3% Gas Chrom Q 80/100*	20/250	General
8195	OV®-225 10% Chromosorb W-HP 80/100	20/250	General
8201	OV®-275 1% Chromosorb W-AW 80/100	20/250	
8203	OV®-275 3% Chromosorb W-AW 80/100	20/250	General
8204	OV®-275 3% Chromosorb W-AW 100/120	20/250	General
8196	OV®-351 3% Chromosorb W-HP 80/100	50/250	General
8197	OV®-351 10% Chromosorb W-HP 80/100	50/250	General
8048	Carbowax 20M 3% Chromosorb W-HP 80/100	60/250	General
8300	Carbowax 20M 10% + KOH 2% W-AW 80/100	60/230	Amines
8302	Carbowax 20M 10% Chromosorb W-AW 80/100	60/250	General
8304	Carbowax 20M-TPA 10% Chromosorb W-AW 80/100	60/250	Free Fatty Acids
8306	QF-1 3% Gas Chrom Q 80/100*		General
8033	SE-30 GC Grade 3% Chromosorb W-HP 80/100	50/300	General
8034	SE-30 GC Grade 3% Gas Chrom Q 80/100*	50/300	General
8037	SE-30 GC Grade 10% Chromosorb W-HP 80/100	50/300	General
8308	Apiezon L 10% Chromosorb W-HP 80/100	20/100	—
8309	Dexsil 300 3% Chromosorb W-HP 100/120	20/450	High Temperature
8022	DEGS 10% Chromosorb W-AW 80/100	20/200	FAME
8651	Tenax 60/80 (15 grams)	0/375	—
8652	Tenax 80/100 (15 grams)	0/375	—
8310	SE-30 4% + OV®-210 6% Chromosorb W-HP 100/120	100/250	Pesticides
8312	OV®-17 1.5% + QF-1 1.95% Gas Chrom Q 80/100*	0/250	Pesticides
8314	OV®-17 1.5% + QF-1 1.95% Chromosorb W-HP 100/120	0/250	Pesticides

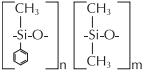
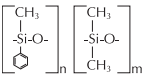
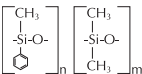
* Call 1-800-729-6872 for more information.

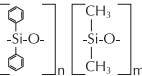
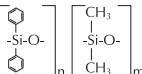
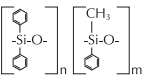
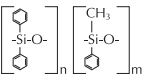
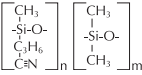
**Intended as a general guide.

OV[®] Liquid Phases Physical Property Data

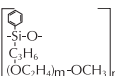
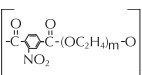
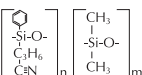
Name	Type	Structure	Solvent	Temp. Limit	Viscosity	Sp Gr. 25°/25°C
OV [®] -1	Dimethylsilicone Gum		Toluene	325-375°C	Gum	0.980
OV [®] -101	Dimethylsilicone		Toluene	325-375°C	1,500	0.975
OV [®] -3	Phenylmethyldimethylsilicone (10% Phenyl)		Acetone	325-375°C	500	0.997
OV [®] -7	Phenylmethyldimethylsilicone (20% Phenyl)		Acetone	325-375°C	500	1.021
OV [®] -11	Phenylmethyldimethylsilicone (35% Phenyl)		Acetone	325-375°C	500	1.057
OV [®] -17	Phenylmethylsilicone (50% Phenyl)		Acetone	350-375°C	1,300	1.092
OV [®] -61	Diphenyldimethylsilicone		Acetone	325-375°C	>50,000	1.090
OV [®] -73	Diphenyldimethylsilicone Gum		Toluene	325-350°C	Gum	0.991
OV [®] -22	Phenylmethyldiphenylsilicone		Acetone	350-375°C	>50 000	1.127
OV [®] -25	Phenylmethyldiphenylsilicone		Acetone	350-375°C	>100,000	1.150
OV [®] -105	Cyanopropylmethyl-Dimethylsilicone		Acetone	275-300°C	1,500	1.01
OV [®] -202	Trifluoropropylmethylsilicone		Chloroform	250-275°C	500	1.252
OV [®] -210	Trifluoropropylmethylsilicone		Chloroform	275-350°C	10,000	1.284
OV [®] -215	Trifluoropropylmethylsilicone Gum		Ethyl Acetate	250-275°C	Gum	1.285
OV [®] -225	Cyanopropylmethyl Phenylmethylsilicone		Acetone	250-300°C	9,000	1.096
OV [®] -275	Dicyanoalkylsilicone		Acetone	250-275°C	20,000	
OV [®] -330	Silicone Carbowax Copolymer		Acetone	250-275°C	500	
OV [®] -351	Polyglycol-Nitroterephthalic		Chloroform	250-270°C	Solid	
OV [®] -1701	Dimethylphenylcyano Substituted Polymer		Acetone	300-325°C	Gum	

See Stationary Phases (OV® Liquid Phases) section for ordering

Reproduced from the *Journal of Chromatographic Science* by permission of Preston Publications, A Division of Preston Industries, Inc.

RI, 25°C	Average Molecular Weight	Δ1			McReynolds Constants			
		Benzene	Butanol	2-Pentanone	Nitropropane	Pyridine	2-Methyl-2-Pentanol	2-Octyne
1.4040	>10 ⁶	16	55	44	65	42	32	23
1.4038	3 x 10 ⁴	17	57	45	67	43	33	23
1.4436	2 x 10 ⁴	44	86	81	124	88	55	46
1.4766	1 x 10 ⁴	69	113	111	171	128	77	66
1.5120	7 x 10 ³	102	142	145	219	178	103	92
1.5397	4 x 10 ³	119	158	162	243	202	112	105
1.5279	4 x 10 ⁴	101	143	142	213	174	99	86
1.4245	8 x 10 ⁵	40	86	76	114	85	57	39
1.5656	8 x 10 ³	160	188	191	283	253	133	132
1.5825	1 x 10 ⁴	178	204	208	305	280	144	147
1.558	3 x 10 ⁴	36	108	93	139	86	74	29
1.381	1 x 10 ⁴	146	238	358	468	310	206	56
1.3816	2 x 10 ⁵	146	238	358	468	310	206	56
1.3816	3 x 10 ⁵	149	240	363	478	315	208	56
1.5016	8 x 10 ³	228	369	338	492	386	282	150
	5 x 10 ³	629	872	763	1106	849	686	318
	5 x 10 ³	222	391	273	417	368	284	158
		335	552	382	583	540	—	—
	5 x 10 ⁴	67	170	153	228	171	—	—

Specially Modified OV[®] Capillary Phases

With the advent of Fused Silica Columns, the need has drastically increased for stable liquid phases which will bond effectively to the walls of the column. We are

therefore very happy to introduce these special OV[®] Silicones. To order these specially modified OV[®] Capillary phases — please include the proper catalog number.

Vinyl* Modified Capillary Phases

Description		Unit	Catalog Number
OV[®]-1 Vinyl Modified	100% Dimethylsilicone	5gm	6001
OV[®]-20 Vinyl Modified	20% Phenyl 80% Methylsilicone	3gm	6020
OV[®]-35 Vinyl Modified	35% Phenyl 65% Methylsilicone	3gm	6035
OV[®]-17 Vinyl Modified	50% Phenyl 50% Methylsilicone	3gm	6017
OV[®]-215 Vinyl Modified	50% Trifluoropropyl 50% Methylsilicone	10gm	1057
OV[®]-1701 Vinyl Modified	Dimethylphenylcyanosilicone	3gm	61701
OV[®]-225 Vinyl Modified	Cyanopropylmethylphenylmethylsilicone	3gm	6225
OV[®]-275 Vinyl Modified	Dicyanoalkylsilicone	3gm	6275

-OH* Modified Capillary Phases

Description		Unit	Catalog Number
OV[®]-101-OH Modified	100% Dimethylsilicone	5gm	6001-OH
OV[®]-17-OH Modified	50% Phenyl 50% Methylsilicone	3gm	6017-OH
OV[®]-61-OH Modified	Diphenyldimethylsilicone	3gm	6061-OH
OV[®]-31-OH Modified	Cyanopropylmethylsilicone	3gm	6031-OH
OV[®]-1701-OH Modified	Dimethylphenylcyanosilicone	3gm	61701-OH
OV[®]-240-OH Modified	Cyanopropylmethylsilicone	3gm	6240-OH
OV[®]-225-OH Modified	Cyanopropylmethylphenylmethylsilicone	3gm	6225-OH

* All capillary phases are 1% vinyl or 1% -OH Modified.

Stationary Phases

Solvent Code: A = Acetone, C = Chloroform, E = Ethyl Acetate, T = Toluene, M = Methanol
 ① Benzene, ② Butanol, ③ 2-Pentanone, ④ Nitropropane, ⑤ Pyridine

Catalog Number	Description	Unit	Suggested Substitute	Solvent	McReynold's					°C Min/Max
					①	②	③	④	⑤	
—	Amine 220*	—	AT-220	C	117	380	181	293	133	0/180
10023	Armeen 2-C*	—		T						0/125
10025	Armeen SD*	—		C						30/100
10017	Apiezon L	25g		C	32	22	15	32	42	20/100
10033	Bentone 34	50g		T,C						20/200
10043	Bis(2-butoxyethyl) Phthalate	20g		M	151	282	227	338	267	20/175
10045	N, N-bis(2-cyanoethyl) formamide	10g		M	690	991	853	1110	1000	20/125
10047	Bis(2-ethylhexyl) Tetrachlorophthalate*	—		C	112	150	123	108	181	0/150
10049	Butane 1,4 diol Succinate	25g			370	571	448	657	611	
10051	Carbowax 400	50g		C	343	653	430			20/100
10053	Carbowax 550	50g		C						20/110
10055	Carbowax 600	50g		C	350	631	428	632	605	20/120
10057	Carbowax 750	50g		C						25/130
10059	Carbowax 1000	50g		M	347	607	418	626	589	40/150
10061	Carbowax 1500	50g		C						40/200
10063	Carbowax 1540	50g		C	371	639	453	666	641	40/200
10065	Carbowax 4000	50g		C	317	545	378	578	521	60/200
10067	Carbowax 6000	50g		C	322	540	369	577	512	60/200
10069	Carbowax 20M	50g		C	322	536	368	572	510	60/250
10071	Carbowax 20M-Terephthalic Acid	50g		C	321	537	367	573	520	60/250
10073	Castorwax*	—		C	108	265	175	229	246	90/200
10079	Chlorowax 70 (chlorinated paraffin)*	—		C						/130
10081	Citroflex A-4 (acetyl tributyl citrate)	50g		A	135	268	202	314	233	-25/180
10083	Citroflex 4 (tributyl citrate)	50g		M	135	286	213	324	262	-15/150
10085	Cyanoethylsucrose	50g		A	647	919	797	1043	976	20/125
10093	Dexsil 300	5g		C	47	80	103	148	96	20/450
10094	Dexsil 400	5g		C	59	114	140	187	173	20/450
10095	Dexsil 410	5g		C	85	165	169	242	180	20/450
10099	Dibutyl Phthalate	50g		M						-20/100
10101	Didecyl Phthalate	25g		A	136	255	213	320	235	20/150
10103	Diethylene Glycol Adipate	25g		A	378	603	460	665	658	20/190
10105	Diethylene Glycol Succinate	25g	DEGS-GC	A	496	746	590	837	835	20/200
10107	Di(2-ethylhexyl) Phthalate*	—		M	135	254	213	320	235	20/150
10109	Di(2-ethylhexyl) Sebacate	50g		A	72	168	108	180	125	-20/125
10111	Diglycerol	10g		M	371	826	560	676	854	20/120
10113	Diisodecyl Adipate	50g		M	71	171	113	185	128	-20/125
10115	Diisodecyl Phthalate	50g		A	84	173	137	218	155	-20/150
10117	Diisooctyl Phthalate*	—		M,A	94	193	154	243	202	0/175
10119	Diisopropyl Phthalate*	—		M						0/100
10121	Dilauryl Phthalate	10g		M	79	158	120	192	158	20/150
10123	Dimer Acid*	—		C						30/100
10127	Dimethylformamide	50g		M						-20/20
10129	Dimethylsulfolane	—		M						20/50
10131	Dimethyl Sufoxide	50g		A						20/30
10133	Dinonyl Phthalate	50g		A	83	183	147	231	159	20/150
10135	Dioctyl Phthalate*	—		A	92	186	150	230	167	-20/100
10137	Diphenylformamide*	—		M						75/1()0
10139	Di-n-propyl Tetrachlorophthalate*	—		M						10/75
10140	EGSS-X	10g		C	484	710	585	831	778	90/225
10141	EPON 1001 (epoxy resin)	50g		C	284	489	406	539	601	65/200
10143	Ethofat 60/25	50g		C	191	382	244	380	333	50/125
10145	Ethylene Glycol Adipate	50g	Hi-Eff 2AP	C	372	577	455	658	619	100/200
10149	Ethylene Glycol Phthalate*	—		C	453	697	602	816	872	
10151	Ethylene Glycol Sebacate*	—		C						100/200
10155	Ethylene Glycol Succinate	25g	Hi-Eff-2BP	C	537	787	643	903	889	100/200

* Call 1-800-729-6872 for more information

Reproduced from the *Journal of Chromatographic Science* by permission of Preston Publications, A Division of Preston Industries, Inc.

Stationary Phases

Solvent Code: A = Acetone, C = Chloroform, E = Ethyl Acetate, T = Toluene, M = Methanol
 ① Benzene, ② Butanol, ③ 2-Pentanone, ④ Nitropropane, ⑤ Pyridine

Catalog Number	Description	Unit	Suggested Substitut	Solvent	McReynold's					°C Min/Max
					①	②	③	④	⑤	
10156	FFAP	25g	OV®-351	C	340	580	397	602	627	00/275
10159	Formamide	50g		M						20/50
10161	Glycerol	50g		M						20/100
10163	Halocarbon Oil 14-25	50g		C						20/150
10165	Hallcomid M-18*	—		A	79	268	130	222	146	40/150
10166	Hallcomid M-18 OL	50g		M,C	89	280	143	239	165	8/150
10171	Hexamethylphosphoramide (HMPA)	50g		M						20/35
10401	Hi-EFF-1AP	25g		C	378	603	460	665	658	20/210
10402	Hi-EFF-2AP	25g		C	372	576	453	655	617	100/210
10405	Hi-EFF-8BP*	—		C	271	444	330	498	463	100/250
10407	Hi-EFF-1BP	25g		C	499	751	593	840		20/200
10408	Hi-EFF-2BP	25g		C	537	787	643	903	889	100/200
10175	Igepal CO-630	50g		M	192	381	253	382	344	100/200
10179	Igepal CO-880	50g		C	259	461	311	482	426	100/200
10181	Igepal CO-990	50g		C	298	508	345	540	475	100/220
10183	B,B,-Iminodipropionitrile	25g		M						1100
10185	JXR*	—	OV®-1	C	15	53	45	64	41	20/300
10187	Kel-F Oil No. 3*	—		A						0/50
10189	Kel-F Oil No. 10	50g		A						20/100
—	Kel-F Wax (Discontinued)*	—		A	55	67	114	143	116	20/220
10201	Lexan (polycarbonate resin)	25g		C						220/270
10203	Mannitol	25g								170/200
10205	Neopentyl Glycol Adipate	25g		C	234	425	312	402	438	50/225
10207	Neopentyl Glycol Sebacate*	—		C	172	327	225	344	326	50/225
10209	Neopentyl Glycol Succinate	10g		C	272	469	366	539	474	50/225
10211	Nujol (paraffin oil)	50g		T	9	5	2	6	11	0/100
10213	Oronite Polybutene 32*	—		C						50/200
10214	Oronite Polybutene 128*	—		C						50/200
10221	B,B,-Oxydipropionitrile	25g		M						20/100
10225	Phenyldiethanolamine	25g		A						00/150
10420	Poly-A-101A*	—		C	115	357	151	262	214	50/275
10421	Poly-A-103	10g		C	115	331	149	263	214	70/275
10423	Poly-I-110	10g		C	115	194	122	204	202	90/275
10424	Poly-S-176	3g		C						150/400
10425	Poly-S-179	3g		C						200/400
10233	Polyphenyl Ether (5 rings) OS-124	25g		C	176	227	224	306	283	20/200
10235	Polyphenyl Ether (6 rings)*			C	182	233	228	313	293	0/250
10237	Polypropylene Glycol	50g		M	128	294	173	264	226	0/150
10239	Polysulfone (Discontinued)*	—		C						250/315
10241	Polyvinylpyrrolidinone (PVP)	50g		M						20/200
10243	Propylene Glycol	50g		C						0/50
10247	Reoplex 400 (polyester)	50g		A	364	619	449	647	671	20/220
10244	Sebaconitrile	20g		C						0/150
—	Silicone AN-600*	—	OV®-225	A						20/300
1011	Silicone DC-11	50g	OV®-101	C	17	86	48	69	56	20/300
1010	Silicone DC-200, 350cstk	50g	OV®-101	C	16	57	45	66	43	20/200
1012	Silicone DC-200, 12,500 cstk	50g	OV®-101	C,T	16	57	45	66	43	0/200
1013	Silicone DC-410	50g		C	18	57	47	68	44	20/300
1014	Silicone DC-401	50g								
1015	Silicone DC-550	50g	OV®-7	C	81	124	124	189	145	20/225
1017	Silicone DC-704	50g		A						20/250
1018	Silicone DC-710	50g		A	107	149	153	228	90	20/225
1019	Silicone DC-HiVac Grease	50g								
1021	Silicone DC-QF-1	50g	OV®-210	A	144	233	355	463	305	20/250
1022	Silicone DC-FS-1265	50g	OV®-210	A	144	233	355	463	305	20/225

* Call 1-800-729-6872 for more information

Reproduced from the *Journal of Chromatographic Science* by permission of Preston Publications, A Division of Preston Industries, Inc.

Stationary Phases

Solvent Code: A = Acetone, C = Chloroform, E = Ethyl Acetate, T = Toluene, M = Methanol
 ① Benzene, ② Butanol, ③ 2-Pentanone, ④ Nitropropane, ⑤ Pyridine

Catalog Number	Description	Unit	Suggested Substitute	Solvent	McReynold's					°C Min/Max
					①	②	③	④	⑤	
1023	Silicone GE-SE-30	50g	OV®-1	C	15	53	44	64	41	50/300
1024	Silicone GE-SE-30 GC Grade	10g	OV®-1	C	15	53	44	64	41	50/350
1025	Silicone GE-SE-52	50g	OV®-73	C	32	72	65	98	67	50/300
1026	Silicone GE-SE-54	50g	OV®-73	C	33	72	66	99	67	100/300
1027	Silicone GE-SF-96	50g	OV®-101	C	12	53	42	61	37	20/250
1029	Silicone GE-XE-60	10g	OV®-225	A	204	381	340	493	367	20/250
1031	Silicone GE-XF-1150	25g								20/250
OV® LIQUID PHASES - MANUFACTURED SPECIFICALLY FOR GC USE										
1041	Silicone OV®-1	10g		T	16	55	44	65	42	100/350
1042	Silicone OV®-3	25g		A	44	86	81	124	88	20/350
1043	Silicone OV®-7	25g		A	69	113	111	171	128	20/350
1044	Silicone OV®-11	25g		A	102	142	145	219	178	0/350
1045	Silicone OV®-17	25g		A	119	158	162	243	202	20/350
1046	Silicone OV®-22	10g		A	160	188	191	283	253	20/350®
1047	Silicone OV®-25	10g		A	178	204	208	305	280	20/350
1048	Silicone OV®-61	10g		A	101	143	142	213	174	20/350
1049	Silicone OV®-73	10g		T	40	86	76	114	85	20/350
1050	Silicone OV®-101	20g		T	17	57	45	67	43	20/350
1051	Silicone OV®-105	10g		A	36	108	93	139	86	20/250
1052	Silicone OV®-202	10g		C	146	238	358	468	310	0/275
1053	Silicone OV®-210	25g		C	146	238	358	468	310	20/275
1057	Silicone OV®-215	10g		E	149	240	363	478	315	20/275
1054	Silicone OV®-225	10g		A	228	369	338	492	386	20/250
1055	Silicone OV®-275	5g		A	629	872	763	1106	849	20/275
1056	Silicone OV®-330	5g		A	222	391	273	417	368	30/250
1058	OV®-351 (Replaces FFAP)	10g		C	335	552	382	583	540	50/250
1059	Silicone OV®-1701	3g		A	67	170	153	228	171	20/325
1083	Silicone Silar 5CP	5g		C	319	495	446	637	531	50/275
1084	Silicone Silar 7CP	5g		C	440	638	605	844	673	50/275
1085	Silicone Silar 9CP	5g		C	489	725	631	910	778	50/275
1086	Silicone Silar 10C	5g		C	523	757	659	942	801	50/275
—	SP-2100*	—	OV®-101	T	17	57	45	67	43	20/350
—	SP-2250*	—	OV®-17	A	119	158	162	243	202	20/350
—	SP-2401*	—	OV®-202	C	146	238	358	468	310	0/275
—	SP-1000*	—	OV®-351	C	332	555	393	583	546	50/250
—	SP-2300*	—	Silar 5CP	C,A	316	495	446	637	530	50/275
—	SP-2310*	—	Silar 7CP	A	440	637	605	840	670	50/275
—	SP-2330*	—	Silar 9CP	A	490	725	630	913	778	50/275
—	SP-2340*	—	Silar 10C	A	520	757	659	942	800	50/275
1032	Silicone UCG L-45	50g	OV®-1							
1033	Silicone UCC W-98	50g	OV®-1							0/300
10323	Span 80 (sorbitan monooleate)	25g		T	97	266	170	216	268	20/150
10325	Squalane	50g		T	0	0	0	0	0	20/150
10326	STAP*	—	OV®-101		345	586	400	610	627	100/225
10327	Squalene	50g		T	152	341	238	329	344	20/150
10329	Sucrose Acetate Isobutyrate (SAIB)	25g		C	172	330	251	378	295	30/200
10335	Tergitol NPX	50g		C	197	380	258	389	351	10/175
10347	THEED	25g		M	463	942	626	801	893	20/125
10353	Tricresyl Phosphate	50g		M	176	321	250	374	299	20/125
10355	Triethanolamine	50g		M						25/75
10357	Trimer Acid*	—		M	94	271	163	182	378	20/200
10359	1,2,3-Tris(2-cyanoethoxy)propane (TCEP)	50g		M	594	857	759	1031	917	29/150
10361	Tris(tetrahydrofurfuryl)Phosphate*	—		A						20/125
10363	Triton X-100	50g		A	203	399	268	402	362	20/190
10365	Triton X-305	50g		A	262	467	314	488	430	20/250
10367	Tween 80	50g		M	227	430	283	438	396	20/160
10373	UCON LB-550-X	50g		M	118	271	158	243	206	20/200
10381	UCON 50-HB-280-X	50g		M	177	362	227	351	302	20/200
10383	UCON 50-HB-2000	50g		A	202	394	253	392	341	20/200
10385	UCON 50-HB-5100	50g		M	214	418	278	421	375	20/200
10389	Versamid 900	50g								190/275

* Call 1-800-729-6872 for more information

Reproduced from the *Journal of Chromatographic Science* by permission of Preston Publications, A Division of Preston Industries, Inc.

Porous Polymers

Porapak

Porapak	Catalog Number			Weight
	50/80	80/100	100/120	
P	8501	8611	8721	20 grams
P-S	8502	8612	8722	20 grams
Q	8503	8613	8723	26 grams
Q-S	8504	8614	8724	26 grams
R	8505	8615	8725	24 grams
S	8506	8616	8726	26 grams
N	8507	8617	8727	29 grams
T	8508	8618	8728	31 grams

Porapak is supplied in packs sufficient to fill 10 columns 6' x 1/8" O.D.

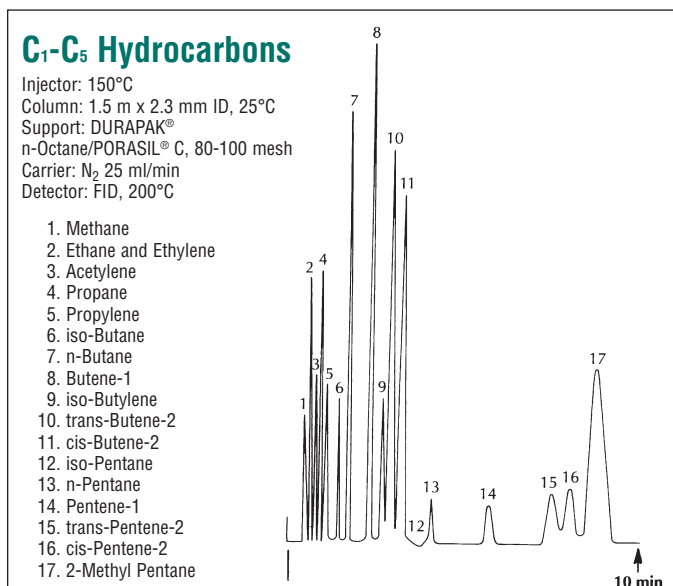
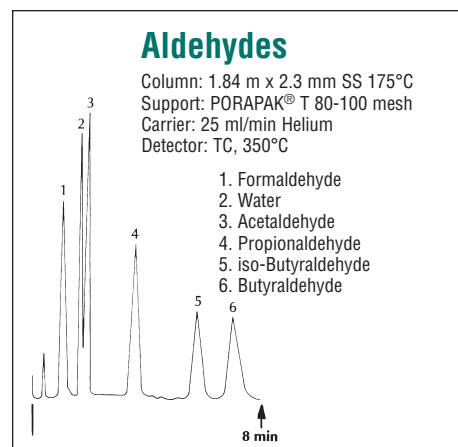
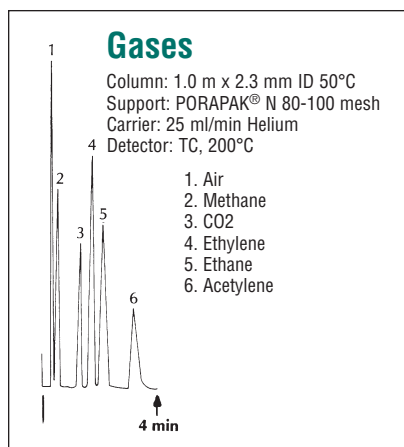
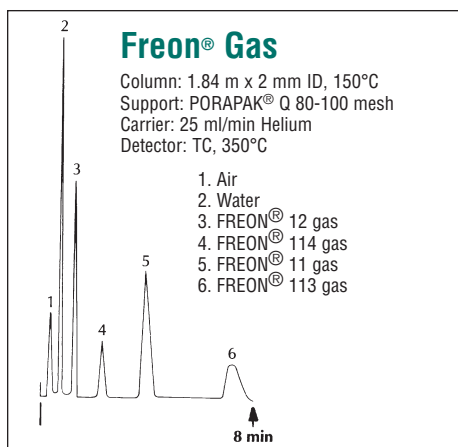

Bonded Porous-Sil™ (75cc) formerly known as Durapak®

Catalog Number	Description	Mesh Size	Max Temp
8550	Carbowax 400/Porous-Sil C	80/100	200°C
8551	N-Octane/Porous-Sil C	80/100	175°C
8552	OPN/Porous-Sil C	80/100	150°C
—	C-18/Porous-Sil C (Disc.)	100/150	200°C
8554	Phenylisocyanate/Porous-Sil C	80/100	60°C

Porous-Sil™ (20gm) formerly known as Porasil

Porous-Sil	80/100 Catalog Number	100/150 Catalog Number
B	8802	8812
C	8803	8813

A note on Porous-Sil™

All Porasil Porous polymer products have been discontinued by The Waters Corporation. Ohio Valley now offers an identical product to the Porasil line.

Porous Polymers

Haysep® (75cc)

Catalog Number	Type	Mesh	MaOT
H8501	P	60/80	
H8611	P	80/100	250°C
H8721	P	100/120	
H8503	Q	60/80	
H8613	Q	80/100	275°C
H8723	Q	100/120	
H8505	R	60/80	
H8615	R	80/100	250°C
H8725	R	100/120	
H8506	S	60/80	
H8616	S	80/100	250°C
H8726	S	100/120	
H8507	N	60/80	
H8617	N	80/100	165°C
H8727	N	100/120	
H8508	T	60/80	
H8618	T	80/100	165°C
H8728	T	100/120	
H8001	A	60/80	
H8002	A	80/100	165°C
H8003	A	100/120	
H8004	B	60/80	
H8005	B	80/100	190°C
H8006	B	100/120	
H8007	C	60/80	
H8008	C	80/100	250°C
H8009	C	100/120	
H8010	D	60/80	
H8011	D	80/100	290°C
H8012	D	100/120	
H8013	DB	60/80	
H8014	DB	80/100	300°C
H8015	DB	100/120	

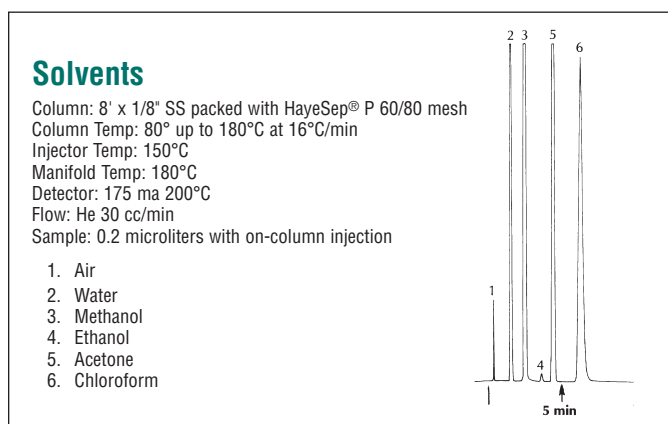
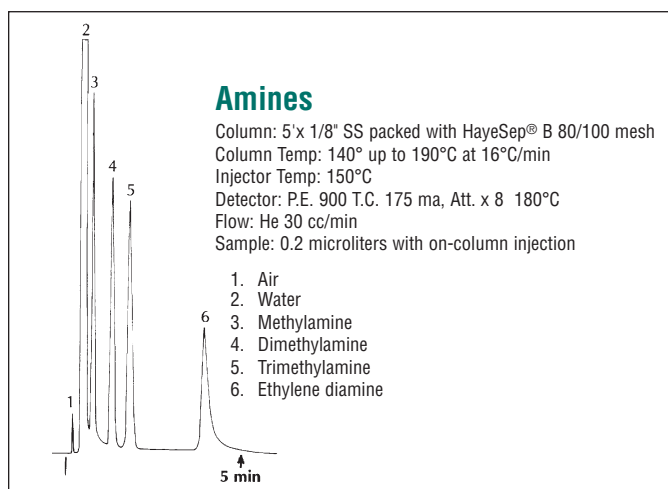

Tenax® (15 grams)

Based on 2, 6-diphenyl-p-phenylene oxide, Tenax is suitable for the separation of high boiling compounds such as alcohols, diols, polyethylene glycol compounds, phenols, mono and diamines, ethanolamines, amides, aldehydes, and ketones. MaOT: 350°C

Catalog Number	Description
8650	Tenax 35/60
8651	Tenax 60/80
8652	Tenax 80/100

Celite® Century Series (50 grams)

Mesh Size	101	102	103	Catalog Number 104	105	106	107	108
60/80	17424	27403	37434	Discontinued	57454	67457	77460	87463
80/100	17425	27404	37435	Discontinued	57455	67458	77461	87464
100/120	17426	27405	37436	Discontinued	57456	67459	77462	87465

Solid Supports

Abbreviations:

AW = Acid Washed

HP = High Performance

DMCS = Dimethyldichlorosilane

Chromosorb W (150 grams)

Mesh Size	NON-AW	Catalog Number		HP
		AW	AW-DMCS	
60/80	7701	7723	7733	7743
80/100	7702	7724	7734	7744
100/120	7703	7725	7735	7745

Chromosorb G (225 grams)

Mesh Size	NON-AW	Catalog Number		HP
		AW	AW-DMCS	
60/80	7801	7823	7833	7843
80/100	7802	7824	7834	7844
100/120	7803	7825	7835	7845

Chromosorb P (454 grams)

Mesh Size	NON-AW	Catalog Number	
		AW	AW-DMCS
60/80	7923	7933	7943
80/100	7924	7934	7944
100/120	7925	7935	7945

Chromosorb T (225 grams)

Mesh Size	Catalog Number
30/60	7523
40/60	7524

Chromosorb 750 (100 grams)

Mesh Size	Catalog Number
60/80	7623
80/100	7624
100/120	7625















Molecular Sieves (100 grams)

Description	Catalog Number
MOLECULAR SIEVE 4A	
40/60 mesh	5320
60/80 mesh	5323
80/100 mesh	5326
100/120 mesh	5330
MOLECULAR SIEVE 5A	
40/60 mesh	5333
60/80 mesh	5336
80/100 mesh	5339
100/120 mesh	5442
MOLECULAR SIEVE 13X	
40/60 mesh	5445
60/80 mesh	5448
80/100 mesh	5451
100/120 mesh	5454
ACTIVATED ALUMINA (Alcoa Type F-1)	
40/60 mesh	5457
60/80 mesh	5460
80/100 mesh	5463
100/120 mesh	5466
SILICA GEL (Davison Grade 12)	
40/60 mesh	5469
60/80 mesh	5472
80/100 mesh	5475
100/120 mesh	5478



Swagelok

Swagelok Fittings	Size (Inches)	Brass		Stainless Steel		PTFE	
		Catalog Number	Qty/Pkg	Catalog Number	Qty/Pkg	Catalog Number	Qty/Pkg
Nuts 	1/16"	B-102-1	Each	SS-102-1	Each	—	—
	1/8"	B-202-1	10 Each	SS-202-1	Each	—	—
	1/4"	B-402-1	10 Each	SS-402-1	Each	—	—
	3/8"	B-602-1	10 Each	SS-602-1	Each	—	—
Front Ferrules 	1/16"	B-103-1	10 Each	SS-103-1	Each	T-103-1	Each
	1/8"	B-203-1	10 Each	SS-203-1	10 Ea.	T-203-1	Each
	1/4"	B-403-1	10 Each	SS-403-1	10 Ea.	T-403-1	Each
Back Ferrules 	1/16"	B-104-1	10 Each	SS-104-1	Each	T-104-1	Each
	1/8"	B-204-1	10 Each	SS-204-1	10 Ea.	T-204-1	Each
	1/4"	B-404-1	10 Each	SS-404-1	10 Ea.	T-404-1	Each
Unions 	1/16"	B-100-6	Each	SS-100-6	Each	—	—
	1/8"	B-200-6	Each	SS-200-6	Each	—	—
	3/16"	B-300-6	Each	—	—	—	—
	1/4"	B-400-6	Each	SS-400-6	Each	—	—
	3/8"	B-600-6	Each	SS-600-6	Each	—	—
Reducer Unions 	1/8" X 1/16"	B-200-6-1	Each	SS-200-6-1	Each	—	—
	3/16" X 1/8"	B-300-6-2	Each	SS-300-6-2	Each	—	—
	1/4" X 1/16"	B-400-6-1	Each	SS-400-6-1	Each	—	—
	1/4" X 1/8"	B-400-6-2	Each	SS-400-6-2	Each	—	—
	3/8" X 1/4"	B-600-6-4	Each	SS-600-6-2	Each	—	—
Bored Thru Unions 	1/8" X 1/8"	—	—	SS-200-6BT	Each	—	—
	1/4" X 1/4"	B-400-6BT	Each	SS-400-6BT	Each	—	—
Union Zero-Dead Volume 	1/16"	B-1F0-6-GC	Each	SS-1F0-6-GC	Each	—	—
Caps 	1/16"	B-100-C	Each	SS-100-C	Each	—	—
	1/8"	B-200-C	Each	SS-200-C	Each	—	—
	1/4"	B-400-C	Each	SS-400-C	Each	—	—
Plugs 	1/16"	B-100-P	Each	SS-100-P	Each	—	—
	1/8"	B-200-P	Each	SS-200-P	Each	—	—
	1/4"	B-400-P	Each	SS-400-P	Each	—	—
Tees 	1/16"	B-100-3	Each	SS-100-3	Each	—	—
	1/8"	B-200-3	Each	SS-200-3	Each	—	—
	1/4"	B-400-3	Each	SS-400-3	Each	—	—
	3/8"	B-600-3	Each	SS-600-3	Each	—	—
Tube Reducers 	1/16" X 1/8"	B-100-R-2	Each	SS-100-R-2	Each	—	—
	1/8" X 1/4"	B-200-R-4	Each	SS-200-R-4	Each	—	—
	3/16" X 1/4"	B-300-R-4	Each	SS-300-R-4	Each	—	—
	3/8" X 1/4"	B-600-R-4	Each	—	—	—	—
	1/4" X 1/8"	B-400-R-2	Each	SS-400-R-2	Each	—	—
Male Pipe Connector 	1/16" X 1/8"	B-100-1-2	Each	SS-100-1-2	Each	—	—
	1/8" X 1/8"	B-200-1-2	Each	SS-200-1-2	Each	—	—
	1/4" X 1/8"	B-400-1-2	Each	SS-400-1-2	Each	—	—
	1/4" X 1/4"	B-400-1-4	Each	SS-400-1-4	Each	—	—
	3/8" X 1/4"	B-600-1-4	Each	SS-600-1-4	Each	—	—
Female Pipe Connector 	1/8" X 1/8"	B-200-7-2	Each	SS-200-7-2	Each	—	—
	1/4" X 1/8"	B-400-7-2	Each	SS-400-7-2	Each	—	—
	1/4" X 1/4"	B-400-7-4	Each	SS-400-7-4	Each	—	—
	3/8" X 1/4"	B-600-7-4	Each	SS-600-7-4	Each	—	—

Choose The Right Ferrule

Ferrule Type	Recommended Use
1/16" x 0.4mm	Capillary tubing with ID of 0.10 - 0.25mm
1/16" x 0.5mm	Capillary tubing with ID of 0.28 - 0.35mm
1/16" x 0.8mm	Capillary tubing with ID of 0.45 - 0.53mm
1/16" x 1.0mm	Capillary tubing with ID of 0.75mm
No Hole	To create custom fittings or for plugs
2-Hole	Connects 2 pieces of capillary tubing to the same fitting



Maximum Operating Temperatures

- 100% Graphite ferrules Maximum operating temperature 450°C
- 85% Polyimide / 15% Graphite . . . Maximum operating temperature 400°C
- 60% Polyimide / 40% Graphite . . . Maximum operating temperature 400°C
- 100% Polyimide ferrules Maximum operating temperature 350°C
- 100% PTFE ferrules Maximum operating temperature 250°C

Quality

Excellent quality. We challenge you to compare any of our ferrules against your current supplier.

Conditioned

All ferrules are thermally conditioned and ready for immediate high temperature GC use.

Advantages of Graphite Ferrules

Our graphite ferrules fit “Swagelok” or “Parker” fittings. Graphite ferrules are soft and compliant. They will not stick to glass at higher temperatures. These ferrules are ideal for glass to metal connections. The graphite ferrule can be reused if not over tightened.

Advantages of Polyimide Ferrules

Improved mixing techniques for polyimide ferrules allow for better homogenous mixing of graphite and polyimide resin. One can observe this when looking at a polyimide ferrule. The surfaces are very smooth and exhibit a highly polished or highly shined surface.

Polyimide ferrules exhibit a lower coefficient of expansion than other polyimide resins, therefore, reducing the tendency of the column nuts loosening in the heated GC ovens.

Advantages of PTFE Ferrules

The PTFE ferrules are a one piece design and require no back ferrule. These ferrules are completely inert.



Ferrules (10 per Pack)

Ferrule Size	Tubing Size	Style	100% Graphite	85% Polyimide 15% Graphite	60% Polyimide 40% Graphite	100% Polyimide	100% PTFE
Capillary Ferrules							
1/16"	0.4mm		GF-04	MS-04	GH-04	HF-04	TF-04
1/16"	0.4mm	HP/Agilent Short	GF-04-HP	MS-04-HP	GH-04-HP	HF-04-HP	
1/16"	0.5mm		GF-05	MS-05	GH-05	HF-05	TF-05
1/16"	0.5mm	HP/Agilent Short	GF-05-HP	MS-05-HP	GH-05-HP	HF-05-HP	
1/16"	0.8mm		GF-08	MS-08	GH-08	HF-08	TF-08
1/16"	0.8mm	HP/Agilent Short	GF-08-HP	MS-08-HP	GH-08-HP	HF-08-HP	
1/16"	1.0mm		GF-10	MS-10	GH-10	HF-10	TF-10
1/16"	1.0mm	HP/Agilent Short	GF-10-HP	MS-10-HP	GH-10-HP	HF-10-HP	
1/16"	1.2mm		GF-12	MS-12	GH-12	HF-12	TF-12
Straight Ferrules							
1/16"	1/16"		GF-01	MS-01	GH-01	HF-01	TF-01
1/8"	1/8"		GF-02	MS-02	GH-02	HF-02	TF-02
3/16"	3/16"		GF-316				TF-316
1/4"	1/4"		GF-03	MS-03	GH-03	HF-03	TF-03
3/8"	3/8"		GF-138				TF-138
1/2"	1/2"		GF-13				TF-13
Reducing Ferrules							
1/8"	0.4mm		GF-48	MS-48	GH-48	HF-48	TF-48
1/8"	0.5mm		GF-58	MS-58	GH-58	HF-58	TF-58
1/8"	0.8mm		GF-88	MS-88	GH-88	HF-88	TF-88
1/8"	1.0mm		GF-18	MS-18	GH-18	HF-18	TF-18
1/8"	1.2mm		GF-38	MS-38	GH-38	HF-38	TF-38
1/8"	1/16"		GF-68	MS-68	GH-68	HF-68	TF-68
1/4"	4.0mm		GF-40	MS-40	GH-40	HF-40	TF-40
1/4"	0.4mm		GF-44	MS-44	GH-44	HF-44	TF-44
1/4"	0.5mm		GF-45	MS-45	GH-45	HF-45	TF-45
1/4"	0.8mm		GF-84	MS-84	GH-84	HF-84	TF-84
1/4"	1/16"		GF-64	MS-64	GH-64	HF-64	TF-64
1/4"	1/8"		GF-81	MS-81	GH-81	HF-81	TF-81
Two-Hole Ferrules							
1/16"	0.4mm	2-Hole	GF-14	MS-14	GH-14	HF-14	TF-14
1/16"	0.5mm	2-Hole	GF-25	MS-15	GH-15	HF-15	TF-15
1/8"	0.5mm	2-Hole	GF-28	MS-28	GH-28	HF-28	TF-28
1/8"	0.8mm	2-Hole	GF-29	MS-29	GH-29	HF-29	TF-29
No-Hole Ferrules							
1/16"		No-Hole	GF-01-NH	MS-01-NH	GH-01-NH	HF-01-NH	TF-01-NH
1/8"		No-Hole	GF-02-NH	MS-02-NH	GH-02-NH	HF-02-NH	TF-02-NH
1/4"		No-Hole	GF-03-NH	MS-03-NH	GH-03-NH	HF-03-NH	TF-03-NH
3/8"		No-Hole	GF-138-NH				TF-138-NH

Note: The above part numbers are supplied as 10 per pack.

Tubing

Stainless Steel: Premium Grade for GC

This premium grade stainless steel is a specially tempered grade for easy bending. It is Type 304 Stainless, manufactured for us, specifically intended for Gas Chromatography. The tubing goes through stringent inner surface treatments by our manufacturer, and again, by our technicians to provide you with the best available stainless steel for your GC columns.



Outside Diameter	Inside Diameter	Per Foot Catalog Number	Per 50 Feet Catalog Number
1/8"	0.085"	5110	5115
3/16"	0.147"	5120	5125
1/4"	0.210"	5130	5135

Nickel GC Grade: Pure Nickel 200

Inner surfaces treated and cleaned — excellent for GC use.

Outside Diameter	Inside Diameter	Per Foot Catalog Number	Per 50 Feet Catalog Number
1/8"	0.085"	5210	5215
1/4"	0.210"	5230	5235

Copper GC Grade

Inner surfaces treated and cleaned — excellent for GC use.

Outside Diameter	Inside Diameter	Per 50 Feet Catalog Number
1/8"	0.065"	5165
1/4"	0.190"	5185

PTFE (TFE)

Outside Diameter	Per 25 Feet - Catalog Number
1/8"	5145
1/4"	5155

Aluminum

Outside Diameter	Per 50 Feet - Catalog Number
1/8"	5190
1/4"	5198



GC "Hook-up" Kit

This kit includes everything you need for either adding a new GC, or changing the plumbing of an existing GC.

Kit Includes:

- 10 qty Swagelok 1/8" Brass Nuts
- 10 qty Swagelok 1/8" Brass Front Ferrules
- 10 qty Swagelok 1/8" Brass Back Ferrules
- 5 qty Swagelok 1/8" Brass Tees
- 1 qty Imp Tubing Cutter
- 1 qty 7/16" Wrench
- 1 qty 1/2" Wrench
- 1 qty 50' Roll Pre-cleaned 1/8" Copper Tubing
- 1 qty Reamer Tool

Description	Catalog Number
GC Hook-up kit	5170

Open End Wrench Set

This wrench set includes the most commonly used sizes for adjusting or repairing chromatograph or other analytical instruments.



- (1) qty of 1/4" x 5/16"
- (1) qty of 7/16" x 1/2"
- (1) qty of 3/8" x 7/16"
- (1) qty of 1/2" x 9/16"

Description	Catalog Number
Open End Wrench Set	5171

Tubing Cutter

Heavy duty unit for cutting all metal tubing used with Gas Chromatography. Makes clean right angle cuts with no burrs or chips to clog the tubing. Includes fold away reamer and spare cutting wheel.



Description	Catalog Number
Tubing Cutter	2-1005

Gas Purifiers



Oxiclear: Oxygen Removal, Disposable

Capable of purifying the contents of 300 cubic feet (900 cubic feet at STP); easily removing oxygen from inert carrier gases down to less than 1 ppm.

Description	Catalog Number
Disposable purifier with 1/4" fittings	DGP-250
Disposable purifier with 1/8" fittings	DGP-125



Labclear: Refillable, Indicating

A mixture of Drierite, an indicating desiccant and a #13X molecular sieve is contained within the transparent LabClear body, indicating a need for refilling. 400cc capacity. Tested at 120 psi and 100°F. (Approximate Size: 14" long x 2" diameter)

Description	Catalog Number
Refillable Indicating Gas Filter with 1/4" fittings	RGF-250
Refillable Indicating Gas Filter with 1/8" fittings	RGF-125



Gas-Dry Filter Trap: Refillable, Indicating

This Gas-Dry Filter Trap effectively removes moisture, oil, dust and purifies hydrogen in flame ionization detectors. Unique O-ring seal allows hand removal of the transparent cartridge for changing contents.

Description	Catalog Number
Gas-Dry Filter with 1/4" fittings	GFT-250
Gas-Dry Filter with 1/8" fittings	GFT-125



Gas Specific Purifiers

- Reduces gas impurities to low PPB levels
- Decreases baseline noise and increases GC/MS sensitivity
- Replace three traps with one purifier

Gas-specific purifiers remove contaminants from the gas stream. These contaminants can be detrimental to your GC performance. The gas specific purifiers are designed to be placed in-line with the GC carrier or detector gas supply. The contaminants — notably moisture, hydrocarbons and oxygen are removed from the analytical gases prior to entering the GC.

Gas Type	Fitting	Catalog Number
Helium	1/8"	P100-1
Helium	1/4"	P100-2
Hydrogen	1/8"	P200-1
Hydrogen	1/4"	P200-2
Nitrogen	1/8"	P300-1
Nitrogen	1/4"	P300-2
Air	1/8"	P400-1
Air	1/4"	P400-2
Methane	1/8"	P500-1
Methane	1/4"	P500-2

Agilent Cross Reference

Agilent Catalog Number	OV® Catalog Number
5182-3427	P100-1
5182-3426	P100-2
5182-3425	P200-1
5182-3424	P200-2
5182-3440	P300-1
5182-3441	P300-2

Septa 77™

Septa 77™ High Temperature Septa

For the first time a soft, resealable septum with extremely low bleed characteristics is available to chromatographers. Hundreds of tests were performed involving Septa 77™ and other High Temperature Septa. The results have conclusively shown that Septa 77™ surpasses them all. Comparative chromatograms show several septa under identical conditions.

Septa 77™ was developed cooperatively by Ohio Valley and Chromatography Research Supplies. This cooperation of experts in silicone chemistry and GC septa has produced a molded septum with the following properties:

- Lowest bleed of any septa
- Soft and resealable
- Molded for dimensional consistency giving more injections per septum, thereby costing less

Size	Catalog Number
Hitachi - 50 per Pack	237765
3/8" (9.5mm) - 50 per Pack	237705
10.0mm - 50 per Pack	237745
7/16" (11mm) - 50 per Pack	237715
1/2" (12.7mm) - 50 per Pack	237725
Shimadzu - 50 per Pack	237735
Agilent 5890 Series 2, Cap Ins (5mm) - 50 per Pack	237785

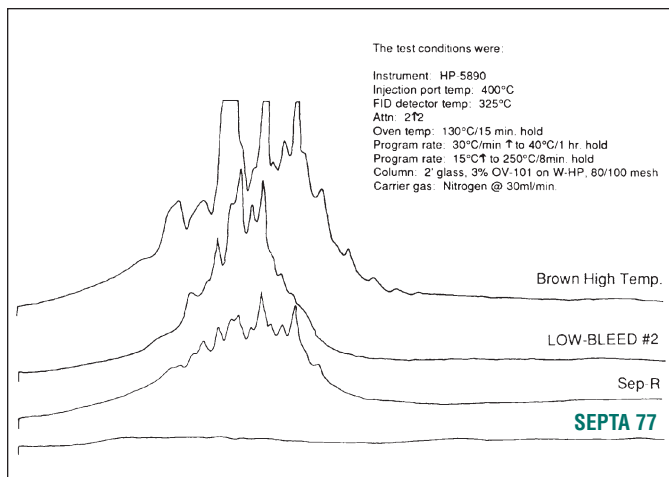

Septum Diameter/Instrument Cross Reference Guide

Size	Company	Instruments
3/8"	Hewlett Packard	5700 Series
3/8"	Tracor	550, 560 models
3/8"	Varian	All models except capillary injectors
3/8"	Gow-Mac	All models
7/16"	Hewlett-Packard	5880/5890
7/16"	Perkin-Elmer	Sigma Series, 900 & 990
7/16"	Varian	Capillary Injectors
1/2"	Hewlett Packard	Models prior to 5700 Series
1/2"	Tracor	220, 222 models
5 mm	Hewlett Packard	Fits HP 5890 Series 2 capillary injectors

Measurement Conversion

Fraction	Decimal	Metric
3/8"	.375"	9.5mm
7/16"	.438"	11.0mm
1/2"	.500"	12.7mm

GC Septa

Type	Description	Diameter	Quantity	Catalog Number
Microsep 532	Two mil ivory TFE PTFE on one face backed by brown silicone rubber. Lowest bleed rate of the Microsep series. Insert this septa in the injection port with PTFE film on column side.	3/8" (9.5mm)*	50	3003
		3/8" (9.5mm)*	100	3005
		1/2" (12.7mm)	50	3053
		1/2" (12.7mm)	100	3055
Microsep 174	Two mil yellow TFE PTFE on one face backed by off-white silicone rubber. Improved version of Microsep 138. Insert in injection port with PTFE film on column side.	1/4" (6mm)	100	3011
		3/8" (9.5mm)*	100	3013
		3/8" (9.5mm)*	250	3014
		3/8" (9.5mm)*	1000	3015
		7/16" (11mm)	100	3019
		1/2" (12.7mm)	100	3064
Microsep 138	Two mil ivory TFE PTFE on one face backed by off-white silicone rubber. Highest bleed rate of Microsep series.	1/4" (6mm)	100	3021
		3/8" (9.5mm)*	100	3024
		3/8" (9.5mm)*	250	3023
		3/8" (9.5mm)*	1000	3025
		7/16" (11mm)	100	3029
		1/2" (12.7mm)	100	3074
Grey	Very good general purpose septa (silicone). Low bleed and well suited for high temperature work. No PTFE.	1/4" (6mm)	100	3041
		3/8" (9.5mm)*	100	3028
		3/8" (9.5mm)*	250	3043
		3/8" (9.5mm)*	1000	3045
		7/16" (11mm)	100	3049
		1/2" (12.7mm)	100	3078
White	White silicone. No PTFE. Good general purpose septa at economical price.	1/4" (6mm)	100	3031
		3/8" (9.5mm)*	100	3032
		3/8" (9.5mm)*	250	3033
		3/8" (9.5mm)*	1000	3035
		7/16" (11mm)	100	3039
		1/2" (12.7mm)	100	3082
Green	High temperature septa. No PTFE. Softer silicone than other green septa available—better resealing properties and longer injection life.	1/4" (6mm)	50	3000
		3/8" (9.5mm)*	50	3036
		7/16" (11mm)	50	3008
		1/2" (12.7mm)	50	3009

* 9.5mm is the recommended size for 3/8" septa. (Rather than 9mm or 10mm)

Septa Needle Guide

- Fewer bent needles
- Prevents septa fragmentation
- Package of two

Description	Catalog Number
Septa Needle Guide	3090





Septum Remover

For removing septa from injection port or septum retainer.

Description	Catalog Number
Septum Remover	3096

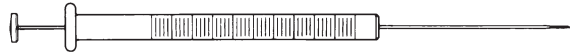
Hamilton Syringes

700 Series Microliter

Syringe Styles	Model Numbers and Capacities					
	701	702	705	710	725	750
	10ul	25ul	50ul	100ul	250ul	500ul
	Catalog Numbers					
N (Cemented Needle)						
	80300	80400	80500	80600	80700	80800
RN (Removable Needle)						
	80330	80430	80530	80630	80730	80830
LT (Luer Tip)						
	80301	80401	80501	80601	80701	80801
Npt5 (Cemented Needle Point Number 5)						
	80339	80439	80539	80639	80739	80839
Accessories						
Chaney Adapter	14700	14725	14725	14725	14725	14725
Guide	14806	14906	14906	14906	14906	14906
Standard RN Needle pack (Pkg./6)	7758-02	7758-03	7758-03	7758-03	7779-03	7779-01
Waters RN Needle pack (Pkg./6)	8647-01	8647-01	8647-01	8647-01	8648-01	8648-01
Rheodyne RN Needle pack (Pkg./6)	7770-01	7770-01	7770-01	7770-01	7780-04	7780-04

701 Series Six-Pack

- Convenient storage container
- We include a set of Ident-A-Dots, six numbered dots which may be applied to your syringes to help you identify syringes used for different samples.

Type	Catalog Numbers
701N	80366
701RN	80336



800 Series Microliter

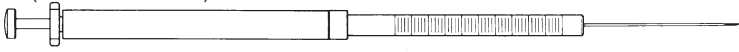
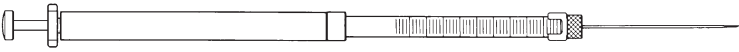



Syringe Styles	Model Numbers and Capacities					
	801	802	805	810	825	
	10ul	25ul	50ul	100ul	250ul	
Catalog Number						
N (Cemented Needle)		84852	84854	84856	84858	84860
RN (Removable Needle)		84853	84855	84857	84859	84861
Accessories						
Chaney Adapter		32146	32146	32146	32146	32146
Standard RN Needle pack (Pkg./6)		7758-02	7758-03	7758-03	7758-03	7779-03
Waters RN Needle pack (Pkg./6)		8647-01	8647-01	8647-01	8647-01	8648-01
Rheodyne RN Needle pack (Pkg./6)		7770-01	7770-01	7770-01	7770-01	7780-04

800 Series Microliter Syringe RNW for Waters Injectors

Model	Volume ul	Needle Gauge	Needle Length	Needle Point	Catalog Number
801RNW	10	25s	1.97"	3	84815
802RNW	25	25s	1.97"	3	84816
805RNW	50	25s	1.97"	3	84817
810RNW	100	25s	1.97"	3	84818
825RNW	250	25s	1.97"	3	84819

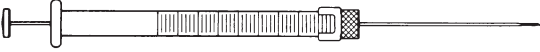

1000 Series Gastight

Syringe Styles	Model Numbers and Capacities					
	1001	1001.25	1002	1005	1010	
	1.0ml	1.25ml	2.5ml	5.0ml	10.0ml	
Catalog Number						
RN (Removable Needle)		81330	—	81430	81530	81630
LT (Luer Tip)		81301	82001	81401	81501	81601
LTN (Luer Tip Needle)		81317	82017	81417	81517	81617
TLL (PTFE Luer Lock)		81320	—	81420	81520	81620
LTN pt5 (Luer Tip Needle Point Number 5)		81343	—	81443	81543	81643
Accessories						
Standard RN Needle pack (Pkg./6)		7779-01	7779-01	7779-01	7779-01	7779-01
Waters RN Needle pack (Pkg./6)		8648-01	8648-01	8648-01	8648-01	8648-01
Rheodyne RN Needle pack (Pkg./6)		7780-04	7780-04	7780-04	7780-04	7780-04

1700 Series Gastight

Syringe Styles	Model Numbers and Capacities						
	1701	1702	1705	1710	1725	1750	
	10ul	25ul	50ul	100ul	250ul	500ul	
Catalog Number							
N (Cemented Needle)		80000	80200	80900	81000	81100	—
RN (Removable Needle)		80030	80230	80930	81030	81130	81230
LT (Luer Tip)		80001	80201	80901	81001	81101	81201
TLL (PTFE Luer Lock)		—	—	80920	81020	81120	81220
LTN (Luer Tip Needle)		—	—	—	—	—	81217
Npt5 (Cemented Needle Point Number 5)		80039	80239	80939	81039	81139	—
Accessories							
Chaney Adapter		14700	14725	14725	14725	14725	14725
Guide		14806	14906	14906	14906	14906	14906
Standard RN Needle pack (Pkg./6)		7758-02	7758-03	7758-03	7758-03	7779-03	7779-01
Waters RN Needle pack (Pkg./6)		8647-01	8647-01	8647-01	8647-01	8648-01	8648-01
Rheodyne RN Needle pack (Pkg./6)		7770-01	7770-01	7770-01	7770-01	7780-04	7780-04

7000 Series Modified Microliter

Syringe Styles	Model Numbers and Capacities						
	7000.5	7001	7101	7002	7102	7105	
	.5ul	1ul	1ul	2ul	2ul	5ul	
Catalog Number							
KH (Knurled Hub) Needle Point Number 2		86259	80135	86211	88411	88511	88011
KH (Knurled Hub) Needle Point Number 3		86250	80100	86200	88400	88500	88000
Accessories							
Chaney Adapter		14725	14725	14725	14725	14725	14725
Guide		14906	14906	14906	14906	14906	14906

700 Series Microliter Syringes ASN (Fixed Needle)



Model	Volume	Length	Needle Specifications		Each Catalog Number	6-Pack Catalog Number
			O.D.	I.D.		
75ASN (26s/1.71"/HP)	5ul	43mm	0.47mm	0.13mm	87988	87989
75ASN (23s/1.71"/HP)	5ul	43mm	0.64mm	0.13mm	87987	87990
701ASN (26s/1.71"/HP)	10ul	43mm	0.47mm	0.13mm	80388	80389
701ASN (23s/1.71"/HP)	10ul	43mm	0.64mm	0.13mm	80387	80390

700 Series Microliter Syringes ASRN (Removable Needle)



Model	Volume	Length	Needle Specifications		Each Catalog Number	6-Pack Catalog Number
			O.D.	I.D.		
75ASRN (26s/1.71"/HP)	5ul	43mm	0.47mm	0.13mm	87958	80458
75ASRN (23s/1.71"/HP)	5ul	43mm	0.64mm	0.13mm	87957	80457
701ASRN (26s/1.71"/HP)	10ul	43mm	0.47mm	0.13mm	80358	80458
701ASRN (23s/1.71"/HP)	10ul	43mm	0.64mm	0.13mm	80357	80457

Digital Syringes

- The only N.I.S.T. traceable, calibrated syringe device available
- Comes completely calibrated with its own "Certificate of Calibration"
- Easy-to-read LCD screen displays volume dispensed within $\pm 0.5\%$ of the syringe volume
- Used with Hamilton syringes with total volumes of 0.5 to 500uL



For Digital Syringe re-calibration, contact us at 1-800-729-6872.



Modified Microliter® Digital Syringes

Model	Volume	Gauge	Length	Point Style 2	Point Style 3
7000.5	.5ul	25	2.75"/70mm	DS86259	DS86250
7001	1ul	25s	2.75"/70mm	DS80135	DS80100
7101	1ul	22s	2.75"/70mm	DS86211	DS86200
7002	2ul	25	2.75"/70mm	DS88411	DS88400
7102	2ul	23	2.75"/70mm	DS88511	DS88500
7105	5ul	24	2.75"/70mm	DS88011	DS88000









Microliter® Digital Syringes

Model	Volume	Gauge	Length	Point Style 2	Point Style 3	Point Style 2
75	5ul	26s	2"/51mm	DS87900		DS87930
701	10ul	26s	2"/51mm	DS80300	DS80383	DS80330
701	10ul	22s	2"/51mm		DS80365	
702	25ul	22s	2"/51mm	DS80400	DS80465	DS80430
705	50ul	22s	2"/51mm	DS80500	DS80565	DS80530
710	100ul	22s	2"/51mm	DS80600	DS80665	DS80630
725	250ul	22s	2"/51mm	DS80700	DS80765	DS80730
750	500ul	22	2"/51mm	DS80800	DS80865	DS80830

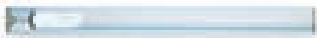
Glass Injection Port Liners

Agilent, Hewlett Packard Deactivated Injection Port Liners

- Deactivated for maximum inertness.
- Meets or exceeds original manufacturers specifications.
- Use liners packed with fused silica wool for the HP 7673 Autosampler.

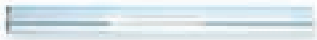
Liner	O.D. x Length (mm)	Glass Type	Deactivated	Catalog Number Each	5 pack	25 pack
 Tapered Liner-1 End 4mm	6.5 x 78.5	Borosilicate	Yes	4209	42095	420925
 Tapered Liner-1 End 4mm with wool*	6.5 x 78.5	Borosilicate	Yes	4210	42105	421025
 Tapered Liner-Both Ends	6.5 x 78.5	Borosilicate	Yes	4211	42115	421125
 Split/Splitless Liner 4mm with wool*	6.3 x 78.5	Borosilicate	Yes	4212	42125	421225
 Cup Split Liner	6.3 x 78.5	Borosilicate	Yes	4202	42025	420225
 Cup Split Liner Packed+	6.3 x 78.5	Borosilicate	Yes	4214	42145	421425
 Splitless Liner 2mm	6.5 x 78.5	Borosilicate	Yes	4206	42065	420625
 Splitless Liner 4mm	6.3 x 78.5	Borosilicate	Yes	4205	42055	420525
 Splitless Liner 2mm with wool	6.5 x 78.5	Borosilicate	Yes	4208	42085	420825

+ The Cup Split Liner (OV® part numbers 4202, 42025 & 420225) contain small amounts of packing (10% OV®-1 on 80/100 Chromosorb-WHP) retained by silanized glasswool.
 * Containing deactivated quartz wool packing to ensure vaporization of your sample before reaching the column entrance, the liner is made of borosilicate glass.

Split Vent Trap Stop Polluting Your Own Environment!

Split Vent Trap which includes a 3-pack of replacement cartridges: Catalog Number 21026

Replacement Cartridges (3-pack): Catalog Number 21023



Impregnated carbon filter media traps a **broad range** of contaminants

- Split or splitless injection systems can vent up to 500 times the amount of sample being analyzed into your lab air.
- Small 'pencil' traps have very limited capacity, are rarely changed and trap a more limited range of contaminants.
- The 'Split Vent Trap' has a high capacity, traps more contaminants, and is easy to change.

Capillary Tubing & Fittings

- Inert
- Pretested
- Increased analytical column lifetime

Guard Columns - Retention Gaps

Guard columns consist of 5 meters of deactivated fused silica supplied with high temperature string. All guard columns are extremely inert and each is pretested.

Guard columns are useful in protecting your analytical column from harmful non-volatile contaminants that are commonly found in many environmental and industrial samples.

Attaching the guard column to the front of the analytical column using fused silica connectors, or a zero dead volume union, will extend your column's lifetime. The non-volatile contaminants are deposited onto the guard column.

For more information, please refer to K. Grob Jr. and R. Mueller, *Journal of Chromatography*, 244 (1982) 185; and K. Grob and B. Schilling, *Journal of Chromatography*, 391 (1987) 318.

Fused Silica Tubing

The Fused Silica Tubing listed below are longer lengths than our popular 5 meter guard columns. They are deactivated using a phenyl-methyl deactivation technique that renders the tubing extremely inert. Acceptable for use in transfer lines.

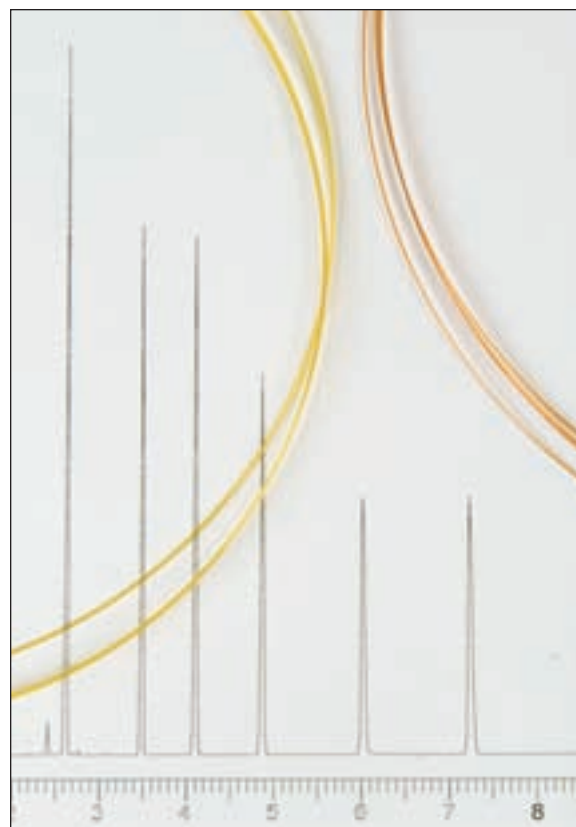

Guard Columns

Length	I.D. mm	Catalog Number
5 Meters	0.18	6180-5
5 Meters	0.25	6250-5
5 Meters	0.32	6320-5
5 Meters	0.53	6530-5

Fused Silica Tubing

Deactivated Supplied on Cage

Length	I.D. mm	Catalog Number
15 Meters	0.18	6180350-15
30 Meters	0.18	6180350-30
60 Meters	0.18	6180350-60
15 Meters	0.25	6250350-15
30 Meters	0.25	6250350-30
60 Meters	0.25	6250350-60
15 Meters	0.32	6320450-15
30 Meters	0.32	6320450-30
60 Meters	0.32	6320450-60
15 Meters	0.53	6530660-15
30 Meters	0.53	6530660-30
60 Meters	0.53	6530660-60

Fused Silica Tubing

Undeactivated Supplied on Cage

Length	I.D. mm	Catalog Number
15 Meters	0.18	180350-15
30 Meters	0.18	180350-30
60 Meters	0.18	180350-60
15 Meters	0.25	250350-15
30 Meters	0.25	250350-30
60 Meters	0.25	250350-60
15 Meters	0.32	320450-15
30 Meters	0.32	320450-30
60 Meters	0.32	320450-60
15 Meters	0.53	530660-15
30 Meters	0.53	530660-30
60 Meters	0.53	530660-60

Fused Silica Connectors

Fused Silica Connectors

- Fits 0.18mm to 0.53mm ID tubing.
- One size fits all, tapered interior bore assures a press-tight friction fit.
- Easy to use - installs quickly.
- Each connector tested for correct tapered angle.
- Excellent for transfer line connections.

Universal union, one size fits all. Excellent for repairing broken columns, or for connecting guard columns.

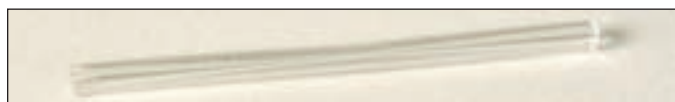

Description	Per Pack	Catalog Number
Universal Union	5/Pack	ML-100
Universal Union	25/Pack	ML-100-25
Universal Union (Deactivated)	5/Pack	ML-100D
Universal Union (Deactivated)	25/Pack	ML-100D-25
Universal Union (Deactivated)	100/Pack	ML-100D-100

“Y” Connector

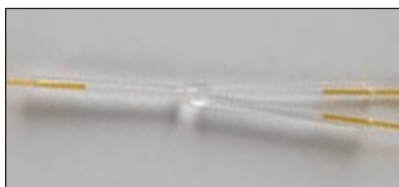

Description	Catalog Number
“Y” Connector	ML-200

Ceramic Cutter

Our ceramic wafer measures 25mm x 25mm, and is used for scoring fused silica tubing. Using our ceramic scoring wafer will insure clean, square cuts.



Description	Catalog Number
Ceramic Cutter (10 per/Pack)	3377

Stainless Steel Connectors

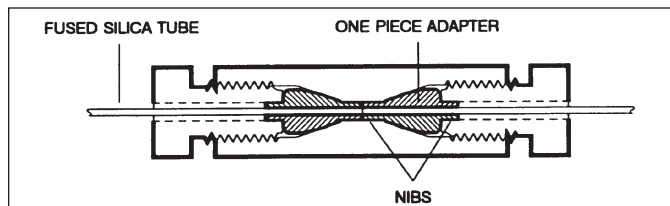

Valco Stainless Steel Connectors permit easy use of open tubular columns with Valco valves, and provide direct connection of fused silica within Valco fittings for maximum bore uniformity and inertness. Because they are machined from a special high density polyimide alloy, Valco fused silica adapters can be used at sustained high temperatures (350°C) without the plastic distortion and shrinkage typical of conventional direct formed ferrules.

Valco one-piece adapters differ from standard ferrules by the addition of special “nibs” on either end. The nib on the back of the ferrule prevents misalignment and cold flow problems. The front nib fills the pilot volume, eliminating dead volume and insuring alignment with the other tubing or with the through bore of the union.

Description	Catalog Number
Straight Unions 0.25-0.25*	55-2525
Straight Unions 0.32-0.32	55-3232
Straight Unions 0.53-0.53	55-5353
Reducing Union 0.32-0.25*	55-3225
Reducing Union 0.53-0.32	55-5332
Reducing Union 0.53-0.25	55-5325

*Fits 0.25 and 0.18mm I.D. tubing.

Diamond-Tipped Pencil



The diamond tipped pencil is still the best tool available to make a clean cut at the end of your capillary column. It is better than silica wafers, carbide scribes, silica prisms, or scissors. It is also easy-to-use.

Description	Catalog Number
Diamond-Tipped Pencil	3374

OV® Capillary Maintenance Kit



This kit contains everything for your capillary lab.

- 10x Illuminated Magnifier
- High Precision Tweezers
- Pin Vise
- 3 Drill Bits (0.41mm, 0.51mm & 0.8mm)
- 3 feet of Pipe Cleaner
- Ceramic Tubing Cutters
- Ruler
- Crescent Wrench
- (3) Nylon Brushes
- Ferrule Remover
- 6 feet of High Temperature String
- Chromatogram Labels

Description	Catalog Number
Capillary Maintenance Kit	2056

Capillary Column Rinsing Reservoir

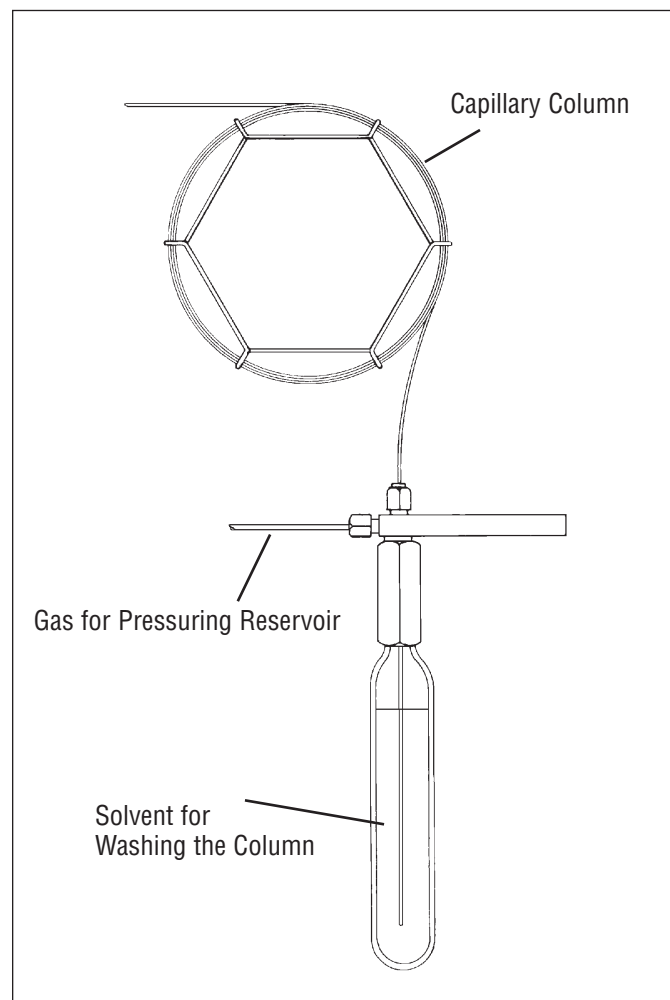

Description	Catalog Number
CC Rinsing Reservoir	6301

Guard Column Kit



The OV® Guard Column kit includes one 5-meter length of deactivated fused silica tubing, five universal fused silica connectors and one ceramic cutting wafer. Using a guard column will increase the lifetime of the column, allows more injections before residue degrades column performance and prevents peak splitting during splitless analysis.

Description	Catalog Number
0.25mm ID Guard Column Kit	62500
0.32mm ID Guard Column Kit	63200
0.53mm ID Guard Column Kit	65300

Leak Detector

Snoop — The liquid leak detector locates leaks in air and carrier gas lines. Supplied with a 12" snooper tube for use in hard-to-reach areas. Non-toxic, Non-flammable. Temperature use range 27°F to 200°F. Supplied in a 8 oz. squeeze bottle.



Description	Catalog Number
Snoop	2-1011

Tubing Cutter

Heavy duty unit for cutting all metal tubing used with Gas Chromatography. Makes clean right angle cuts with no burrs or chips to clog the tubing. Includes fold away reamer and spare cutting wheel.



Description	Catalog Number
Tubing Cutter	2-1005

Glass Wool Extractor

Insert in column, twist slightly to hook glass wool and pull. (Depth approximately 3")

Description	Catalog Number
Extractor	3340

PTFE Tape

PTFE tape is useful as a dry thread lubricant and sealant wherever threaded connections are involved. Will not bake hard and provides a better seal with less torque.



Description	Catalog Number
PTFE Tape	2-1015

Column Tags

These aluminum tags are designed to be attached to the column for permanent identification. Tags can be engraved using a vibrator or simply with a ball point pen. Packed 100 to a bag.



Description	Catalog Number
Tags 100/bag	2-1001

Column Caps

Flexible vinyl caps for protecting your GC columns while not in use. The caps fit snugly over the ends to protect them from contamination. Packaged 100 to the bag.



Description	Catalog Number
Caps 1/8"	2-0018
Caps 3/16"	2-0316
Caps 1/4"	2-0014
Caps 3/8"	2-0038

Glass Wool

Description	Catalog Number
Untreated Glass Wool - 50gm	3350
Quartz Wool - 15gm	3351
DMCS Treated Glass Wool - 50gm	3352



Tubing Bender

Bends 1/8", 3/16" and 1/4" Tubing



Description	Catalog Number
Tubing Bender	3356

Stainless Steel Microprobes

Now you can reach into all those places you probably shouldn't

- Stainless steel
- Hardened and tempered
- Highly Polished
- Needle Sharp
- Complete set of Five

Uses:

- Excellent for removing Septa
- Hooking springs
- Cleaning small parts
- Adjusting electronics
- Positioning samples under a microscope



Description	Catalog Number
Stainless Steel Microprobes	3375

Injection Port Cleaning Kit

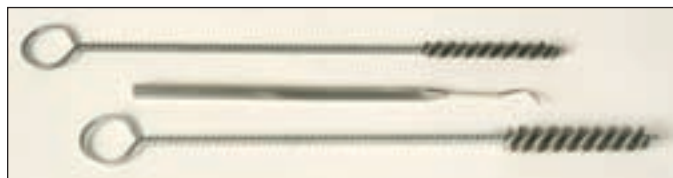

The Injection Port Cleaning Kit eliminates residual carbon and polymerization products that adsorb components and skew peaks. This kit improves GC performance. The Injection Port Cleaning Kit contains two brushes with stainless steel bristles and one scraper for removing septum residue. This kit can be used on all standard instruments.

Description	Catalog Number
Injection Port Cleaning Kit	3370

Column Installation Kit

Kit contains:

- 2 oz. Bottle of "Snoop" Leak Detector
- 3 Lens Magnifier
- Ferrule Tool
- Adjustable Pocket Mirror
- Diamond Tip Pencil



Description	Catalog Number
Column Installation Kit	6304

Flame Detector Cleaning Kit

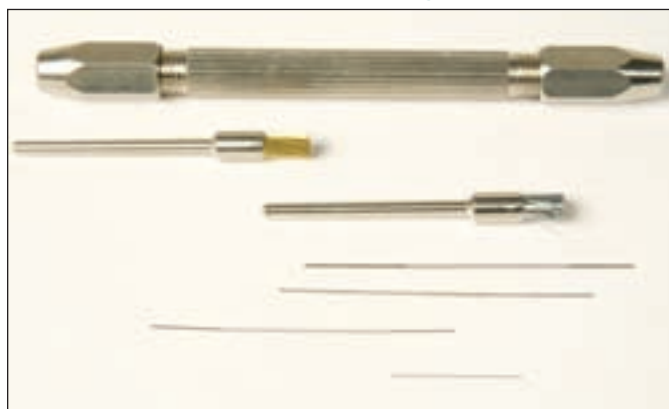

The Flame Detector Cleaning Kit improves sensitivity, reduces noise and spikes. With this kit you can clean your detector when it is taken apart or assembled. The complete flame jet maintenance kit includes: a set of jet reamers with a unique spiral design that cleans without scratching; two wire minibrushes (one stainless steel and the other brass); and a new dual ended handle for reamers and brushes. This kit is easy to use and effective.

Description	Catalog Number
FID Cleaning Kit	3372

Injection Port Liner Cleaning Kit

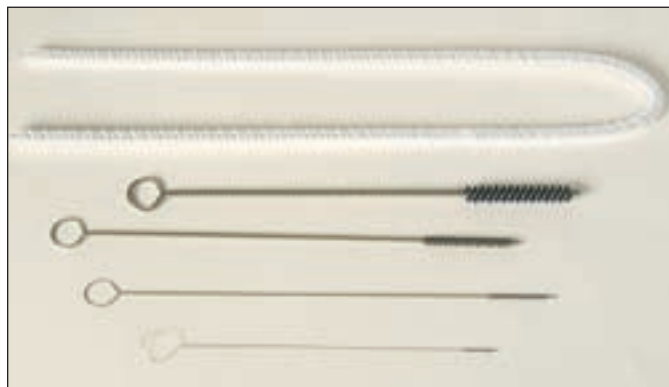

OV® offers the Liner Cleaning Kit to help extend the life of your injection port liners. Four sizes of Nylon brushes are included to clean most liners. The 4mm and 2mm brushes clean standard liners. The 1mm and 0.5mm brushes can clean the inside of reversible tapered liners. Twelve inches of pipe cleaner is provided for light duty jobs. Make the Liner Cleaning Kit part of your regular maintenance routine.

Description	Catalog Number
Injection Port Liner Cleaning Kit	3373



Fused Silicon Unions & “Y” Connectors



- Tapered interior bore assures a press-tight friction fit
- One size fits 0.25, 0.32 or 0.53mm tubing

Description	Catalog Number
Universal “Press Fit” 5/pack	ML-100
Polyimide Resin, 5 gm	ML-300

20x Magnifier

Enough magnifying power to actually see the detail of the end of a capillary column. It is small, powerful, convenient and easy-to-use.



Description	Catalog Number
20x Magnifier	3371

Diamond-Tipped Pencil



The diamond tipped pencil is still the best tool available to make a clean cut at the end of your capillary column. It is better than silica wafers, carbide scribes, silica prisms, or scissors. It is also easy-to-use.

Description	Catalog Number
Diamond-Tipped Pencil	3374

Electronic Crimper Kit

Electronic Crimper, 11mm complete kit includes Crimper, (1) Battery, (1) Battery Charger. For 12mm x 32mm crimp vials.



Description	Catalog Number
Electronic Crimper 11mm Kit	24304

Electronic Decapper Kit



Electronic Decapper, 11mm complete kit includes Decapper, (1) Battery, (1) Battery Charger. For 12mm x 32mm crimp vials.

Description	Catalog Number
Electronic Decapper 11mm Kit	24374

Crimp Top Autosampler Vials



- Crimp vials have the wide (6.0mm) opening.
- Crimp vial size: 12mm dia. x 32mm height.
- Glass Type: Class A, 33 Expansion Borosilicate Glass.
- Crimp vial fits: Agilent (HP) Autosampler and many others.

Vials Description	Catalog Number	Quantity
2.0ml Crimp Vial - Clear	25175	100
2.0ml Crimp Vial - Clear	25175-10	1000
2.0ml Crimp Vial - Clear Silane Treated	25176	100
2.0ml Crimp Vial - Clear Silane Treated	25176-10	1000
2.0ml Crimp Vial - Clear with Marking Spot	25177	100
2.0ml Crimp Vial - Clear with Marking Spot	25177-10	1000
2.0ml Crimp Vial - Amber	23685	100
2.0ml Crimp Vial - Amber	23685-10	1000
2.0ml Crimp Vial - Amber with Marking Spot	23684	100
2.0ml Crimp Vial - Amber with Marking Spot	23684-10	1000
100ul Crimp V-vial - Clear	98621	100

Inserts	Catalog Number	Quantity
250ul Insert Glass - Clear with Bottom Spring	40001	100
250ul Insert Glass - Clear with Bottom Spring	40001-10	1000

Aluminum Seals w/PTFE faced butyl rubber liner	Catalog Number	Quantity
11mm Crimp Seals - Silver	14211	100
11mm Crimp Seals - Silver	14211-10	1000
11mm Crimp Seals - Red	14214	100
11mm Crimp Seals - Red	14214-10	1000
11mm Crimp Seals - Gold	14215	100
11mm Crimp Seals - Gold	14215-10	1000
11mm Crimp Seals - Blue	14212	100
11mm Crimp Seals - Blue	14212-10	1000
11mm Crimp Seals - Green	14213	100
11mm Crimp Seals - Green	14213-10	1000

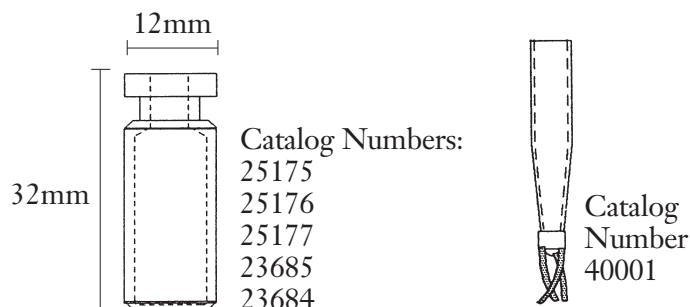

Crimp Top Combo Pack



2.0ml crimp vials, clear with PTFE-faced butyl rubber 11mm aluminum seals. The most convenient and economical way to purchase crimp top autosampler vials and caps. Packaged 100 seals and 100 vials each in separate, clear compartments. Vials and seals remain dust-free.

Description	Quantity	Catalog Number
Crimp Top Combo Pack	100	25175C
Crimp Top Combo Pack	1000	25175-10C Best Buy!

Crimpers & Decappers



Decapper 24371

Crimper 24301

Description	Catalog Number
11mm Hand Crimper	24301
11mm Hand Decapper	24371

Robotic Autosampler Vials

- Robotic Caps eliminate the need for a crimping or decapping tool.
- Robotic vial size: 12mm dia. x 32mm height.
- Glass Type: Class A, 33 Expansion Borosilicate Glass.
- Robotic vial fits: Agilent (HP) Autosampler and many others.

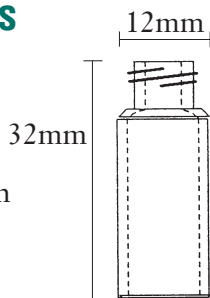

Vials Description	Catalog Number	Quantity
2.0ml Glass Vial - Robotic Clear	25266	100
2.0ml Glass Vial - Robotic Clear	25266-10	1000
2.0ml Glass Vial - Robotic Amber	25268	100
2.0ml Glass Vial - Robotic Amber	25268-10	1000
2.0ml Glass Vial - Robotic Clear w/Marking Spot	25267	100
2.0ml Glass Vial - Robotic Clear w/Marking Spot	25267-10	1000
2.0ml Glass Vial - Robotic Amber w/Marking Spot	25269	100
2.0ml Glass Vial - Robotic Amber w/Marking Spot	25269-10	1000

Preassembled Closure and Septa (9mm)	Catalog Number	Quantity
11mm Robotic Cap - Black w/PTFE Red Rubber	25220	100
11mm Robotic Cap - Black w/PTFE Red Rubber	25220-10	1000
11mm Robotic Cap - Black w/PTFE Silicone	25230	100
11mm Robotic Cap - Black w/PTFE Silicone	25230-10	1000
11mm Robotic Cap - Black w/PTFE Silicone PTFE	25250	100
11mm Robotic Cap - Black w/PTFE Silicone PTFE	25250-10	1000

The above caps are also available in Blue, Green, Natural, Red and Yellow. Please call for details.

Stack Racks fits all 12mm x 32mm Vials



Description	Catalog Number
Stack Rack 50 Position - White	251501
Stack Rack 50 Position - Blue	251502

Robotic Vial Combo Packs

Components are packaged in a clear storage container. Each container has 100 vials and 100 caps/seals. The packs of 1000 are sent as 10 x 100 packs.



Description	Catalog Number	Quantity
2.0ml Glass Vial - Robotic Clear w/PTFE Red Rubber Black Closure	25266C	100
2.0ml Glass Vial - Robotic Clear w/PTFE Red Rubber Black Closure	25266C-10	1000
2.0ml Glass Vial - Robotic Amber w/PTFE Red Rubber Black Closure	25268C	100
2.0ml Glass Vial - Robotic Amber w/PTFE Red Rubber Black Closure	25268C-10	1000

Any combination of vial, cap/seal and liner is available. Please call for details.

Snap-Lok™ Autosampler Vials

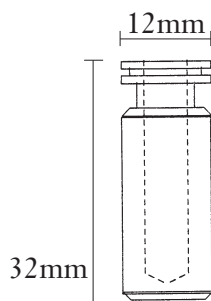

- Snap-Lok caps eliminate the need for crimping or decapping tools.
- Snap-Lok vials can be used with Snap-Lok caps, or Standard Crimp seals.
- Snap-Lok vial size: 12mm dia. x 32mm height.
- Glass Type: Class A, 33 Expansion Borosilicate Glass.
- Snap-Lok vial fits: Agilent (HP) Autosampler and many others.

Catalog Number 30000
Catalog Number 30005

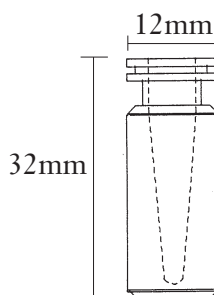

Catalog Number 30010

Vials Volume/Description	Catalog Number	Quantity
2.0ml Glass Vial - Snap-Lok™ Clear	30000	100
2.0ml Glass Vial - Snap-Lok™ Clear	130000	1000
2.0ml Glass Vial - Snap-Lok™ Amber	30005	100
2.0ml Glass Vial - Snap-Lok™ Amber	130005	1000
100ul Glass Vial - Snap-Lok™ Clear	30010	50

These 11mm Low Density Polyethylene* Snap-Lok Caps are available with red PTFE/white Silicone .045" liners. Color Coded Snap-Lok caps allow for easy sample identification.



Caps	Catalog Number	Quantity
11mm Snap-Lok™ Caps - Natural	30030	100
11mm Snap-Lok™ Caps - Natural	130030	1000
11mm Snap-Lok™ Caps - Red	30035	100
11mm Snap-Lok™ Caps - Red	130035	1000
11mm Snap-Lok™ Caps - Yellow	30040	100
11mm Snap-Lok™ Caps - Yellow	130040	1000
11mm Snap-Lok™ Caps - Blue	30045	100
11mm Snap-Lok™ Caps - Blue	130045	1000
11mm Snap-Lok™ Caps - Green	30050	100
11mm Snap-Lok™ Caps - Green	130050	1000

Screw Cap Autosampler Vials



- Screw Cap vial size: 12mm dia. x 32mm height.
- Glass Type: Type 1, 33 Expansion Borosilicate Glass.
- Screw Cap vial fits: Agilent (HP) Autosampler and many others.

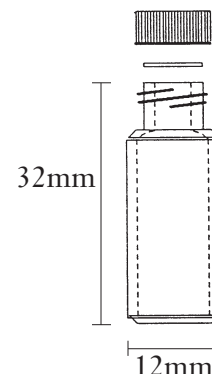

Vials Volume/Description	Catalog Number	Quantity
1.8ml Glass Vial - Clear	13119	100
1.8ml Glass Vial - Clear	13119-10	1000
1.8ml Glass Vial - Clear w/Marking Spot	13219	100
1.8ml Glass Vial - Clear w/Marking Spot	13219-10	1000
1.8ml Glass Vial - Amber	13180	100
1.8ml Glass Vial - Amber	13180-10	1000

Open Top Caps	Catalog Number	Quantity
Polypropylene Open Hole - Black	13200	100
Polypropylene Open Hole - Black	13200-10	1000

Septa	Catalog Number	Quantity
0.045" Septa - Red PTFE/Silicone	13105	100
0.045" Septa - Red PTFE/Silicone	13105-10	1000
0.065" Septa - Red PTFE/Silicone	13115	100
0.065" Septa - Red PTFE/Silicone	13115-10	1000

EPA/VOA Vials

Series 3000 EPA Vials Precleaned



The Series 3000 EPA vials have been cleaned to exact EPA Protocol B specifications and *supplied with a cleaning certification.*

The Series 3000 vials are precleaned, supplied with 0.125" PTFE/Silicone septa and open-top caps, and completely assembled (72 vials per case).

Size	Description	Quantity	Catalog Numbers	
			Clear	Amber
20ml	Series 3000 EPA Vials	72	18956	18966
40ml	Series 3000 EPA Vials	72	18958	18968

Series 2000 EPA Vials Precleaned

The Series 2000 vials are precleaned, supplied with 0.125" PTFE/Silicone septa and open-top caps, and completely assembled (72 vials per case).

The Series 2000 EPA vials have been cleaned to exact EPA Protocol B specifications. A cleaning procedure sheet is enclosed with each case of vials (72 vials per case).

Size	Description	Quantity	Catalog Numbers	
			Clear	Amber
20ml	Series 2000 EPA Vials	72	18952	18962
40ml	Series 2000 EPA Vials	72	18954	18964

Screw Cap Septum Vials

General Screw Cap Septum Vials (not washed) Open Top Screw Caps and Septum Included				Replacement Parts			
Size	Dimensions Dia x Ht (mm) ±1mm	Clear Pack Qty 72	Amber Pack Qty 72	PTFE®/Silicone Discs Pack Qty 72	PTFE®/Rubber Laminated Discs Pack Qty 72	Mininert® Valves Pack Qty 12	Open Top Screw Caps Pack Qty 72
3.5ml	15 x 45	25789	25804	25714	25732	25719	40510
7ml	17 x 60	25791	25806	25716	25734	25721	40512
14ml	21 x 70	25793	25808	25718	25736	25723	40514
20ml	27 x 56	25795	25811	25720	25738	25725	40516
40ml	27 x 95	25797	25812	25722	25740	25726	40518

Glass Serum Vials

Crimp-Top Vials

Dimensions		Size	Seal	Package Quantity	Catalog Numbers	
Diameter	Height				Clear	Amber
23mm	47mm	5ml	20mm	72	23738	23778
25mm	54mm	10ml	20mm	72	23739	23779
32mm	58mm	20ml	20mm	72	23742	23782
37mm	63mm	30ml	20mm	72	23743	23783
43mm	73mm	50ml	20mm	72	23745	23785
52mm	95mm	100ml	20mm	72	23747	23787

20mm ColorCoded™ Aluminum Seals

Color	Package Quantity	Catalog Number
Red	144	13400
Gold	144	13405
Green	144	13410
Blue	144	13415
Silver	144	24183

Bulk Quantities







All Vials, Seals, Septa and Stoppers can be purchased in bulk quantities. Please call our Sales Department at 1-800-729-6872 for a firm quotation.



20mm Septa and Stoppers

Septa and discs are molded of highly inert elastomers.

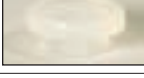
Testing against materials used is recommended before extended use.

	Description	Package Quantity	Catalog Number
	PTFE/Silicone - 10 mils PTFE structurally bonded to silicone. Gives silicone resealability plus PTFE protection.	72	22720
	PTFE/Butyl - Sealing surfaces of butyl and PTFE effect a more positive seal than other PTFE/Butyl septa.	72	19397
	PTFE/Butyl Stopper - PTFE coated Butyl rubber in stopper form.	72	24168
	Butyl Rubber Stopper - Broadly useful elastomer, highly inert to many organic compounds and solvents.	72	24050
	Silicone Rubber Stopper - Excellent resealing properties but affected by numerous organic solvents.	72	24163
	Viton Stopper - Fluorinated elastomer resistant to many corrosive organics. Not recommended for use with amines.	72	13235



Vial Accessories

Serum Vial Accessories

Description	Pack Quantity	Catalog Number
20mm Mininert® Valve	12 Each	24488
20mm Hand Crimper	Each	24303
20mm Hand Decapper	Each	24373



20mm Mininert® Valve



Crimper 24303



Decapper 24373

Micro-Product Vials

- Conical interior bottoms assure downward drainage for maximum retrieval of contents.
- Permits use of milliliter and sub-milliliter samples. Contents are magnified for easier withdrawal.
- Multi-purpose. Can be used for small scale reactions, centrifugalization, storage, and shipping.
- Borosilicate, U.S.P. Type I glass, to safeguard against a change of product ph caused by ordinary glass.
- Convenient plastic packs with foam cell inserts; excellent for storage and handling.
- Graduated



Item: Description	Package Quantity	0.3ml Size 13 x 34mm* Catalog Number	1.0ml Size: 13 x 44mm* Catalog Number	3.0ml Size: 20 x 51mm* Catalog Number	5.0ml Size: 20 x 64mm* Catalog Number
Micro Vials: 12 Vials, with open-top screw caps and PTFE silicone discs.	12	4003	4010	4030	4050
Discs: Replacement PTFE/silicone disc - 10 mils PTFE	72	4013	4013	4035	4035
Tops (open): Open-top screw caps	72	4060	4060	4070	4070
Mininert® Valves	12	4188	4188	4189	4189
Magnetic Stirrers	6	4193	4193	4195	4195

* Sizes: Diameter x Height (mm)

Surface Protector

BYTAC®

- Pressure sensitive surface protection
- The inexpensive way to put fluoropolymer protection on any surface
- Keep your sample prep area completely protected and chemically inert. Use BYTAC® surface protection in all of your labs.
- Use BYTAC® on bench tops and around GCs.
- Use BYTAC® in the bottom of your hoods or to line your chemical storage cabinets.
- Made from a layer of fluoropolymer film on a smooth, tough vinyl or aluminum-foil support backing with a repositionable type of pressure-sensitive adhesive.
- Not effected by weather, moisture or most chemicals.
- Easily cuts with scissors.

General Purpose BYTAC®

Vinyl Supported Surface Protection

Temperature Range: Up to 200°F (93°C)

Construction: .001" PTFE® FEP film on .008" vinyl

Adhesive: Repositionable type, pressure-sensitive

Description	Size	Catalog Number
General Purpose BYTAC®	25 inches x 5 yards	1069324

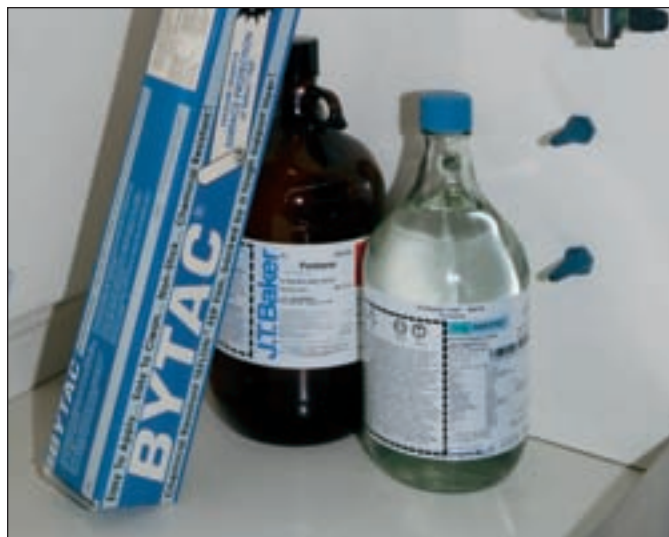

High Temperature BYTAC®

Aluminum Foil Supported Surface Protection

Temperature Range: Up to 360°F (182°C)

Construction: .001" FEP film on .002" aluminum foil

Adhesive: Repositionable type, pressure-sensitive

Description	Size	Catalog Number
High Temperature BYTAC®	25 inches x 5 yards	1069329

Silylation Reagents

TMSI and BSA

- Immediate Delivery
- Guaranteed to be free of all reactive contaminants
- Distilled in Glass

Description	Container	Size	Catalog Number
TMSI	Bottle	25g	140-25
TMSI	Bottle	50g	140-50
TMSI	Bottle	100g	140-100
TMSI	Serum Vial	10g	140-10V
TMSI	Serum Vial	25g	140-25V
TMSI	Serum Vial	100g	140-100V
TMSI	Serum Vial	10 X 1ml	140-1V
BSA	Bottle	25g	203-25
BSA	Bottle	50g	203-50
BSA	Bottle	100g	203-100
BSA	Serum Vial	10g	203-10V
BSA	Serum Vial	25g	203-25V
BSA	Serum Vial	100g	203-100V
BSA	Serum Vial	10 X 1ml	203-1V



TMSI

N-Trimethylsilylimidazole
 $(\text{CH}_3)_3\text{SiNCH} = \text{NCH} = \text{CN}$

M.W. 140.3
 B.P. 100/14mm

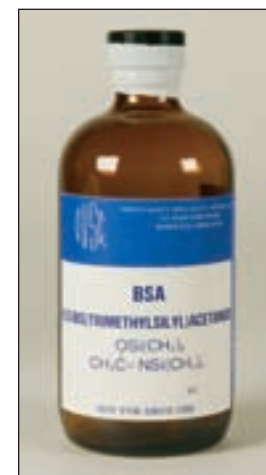

BSA

N,O-Bis(trimethylsilyl)acetamide

M.W. 203.4
 B.P. 55/35mm

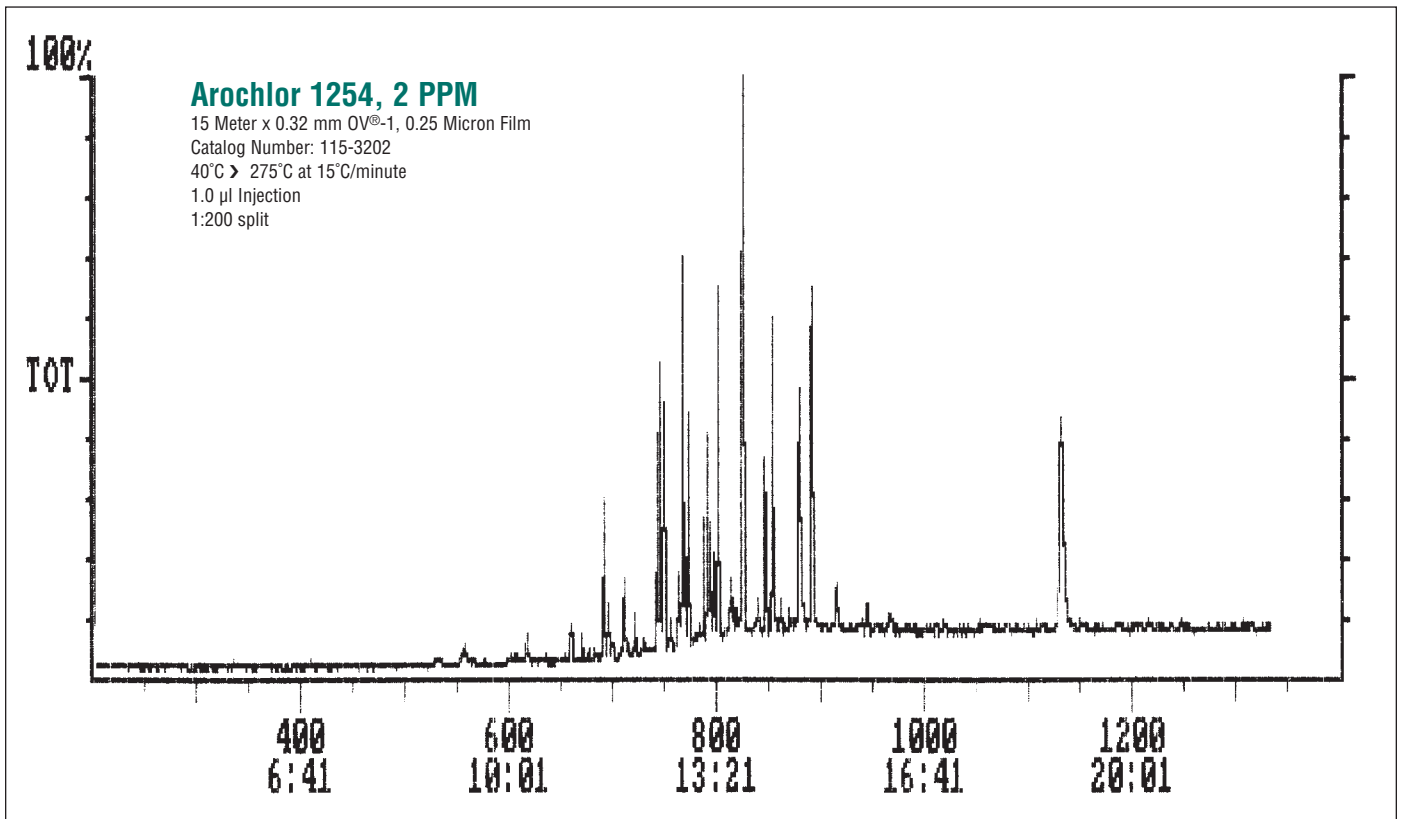
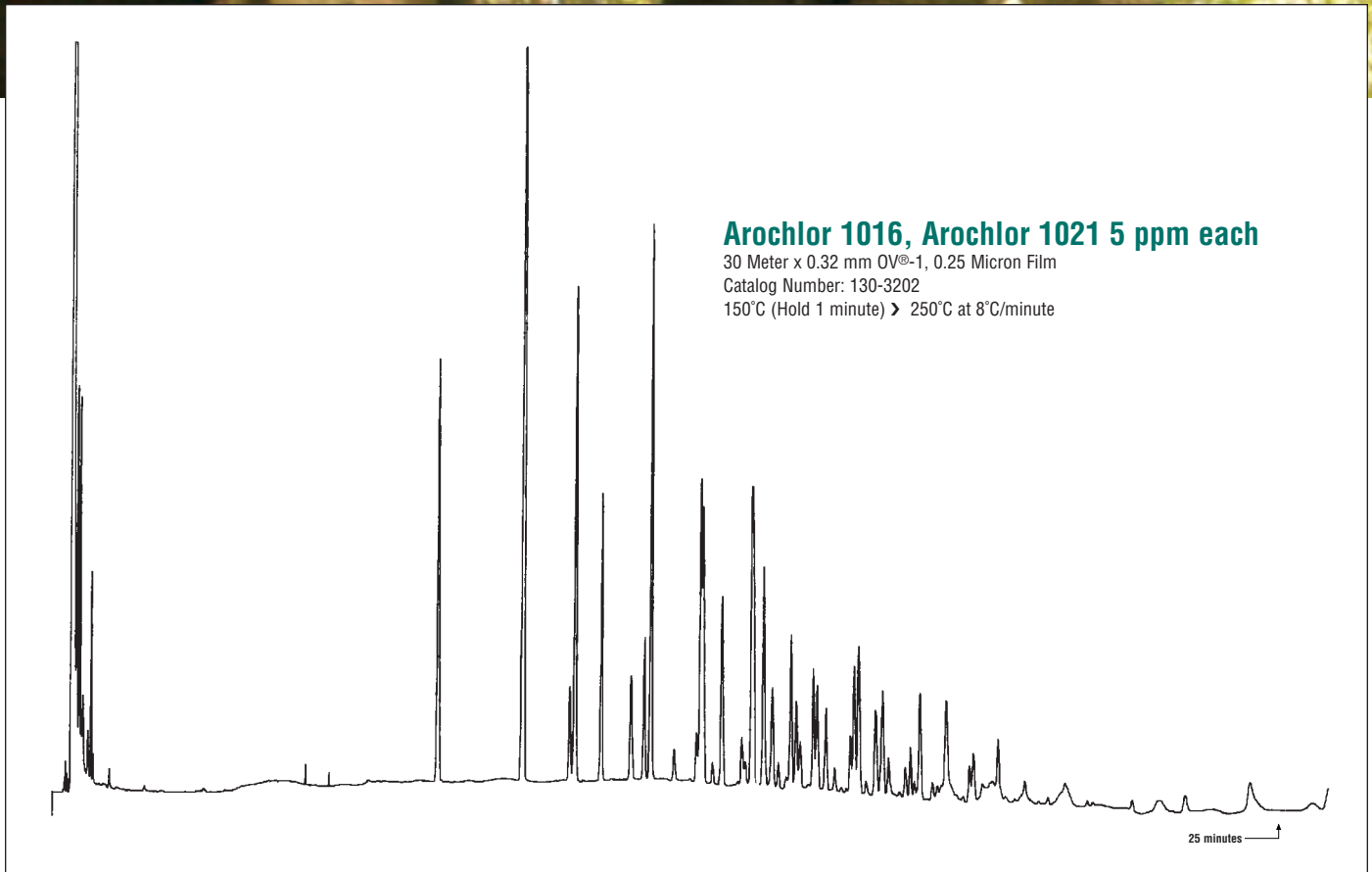

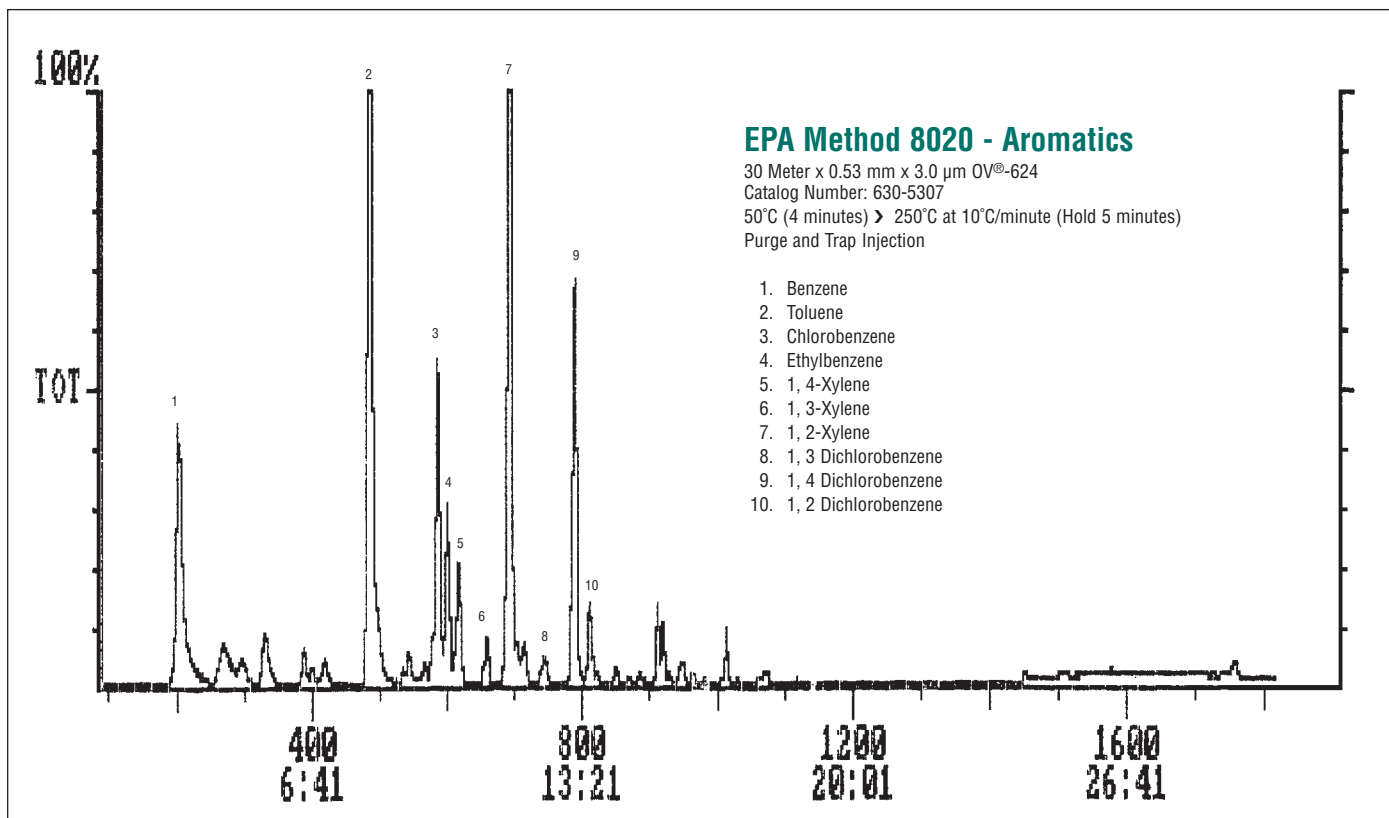
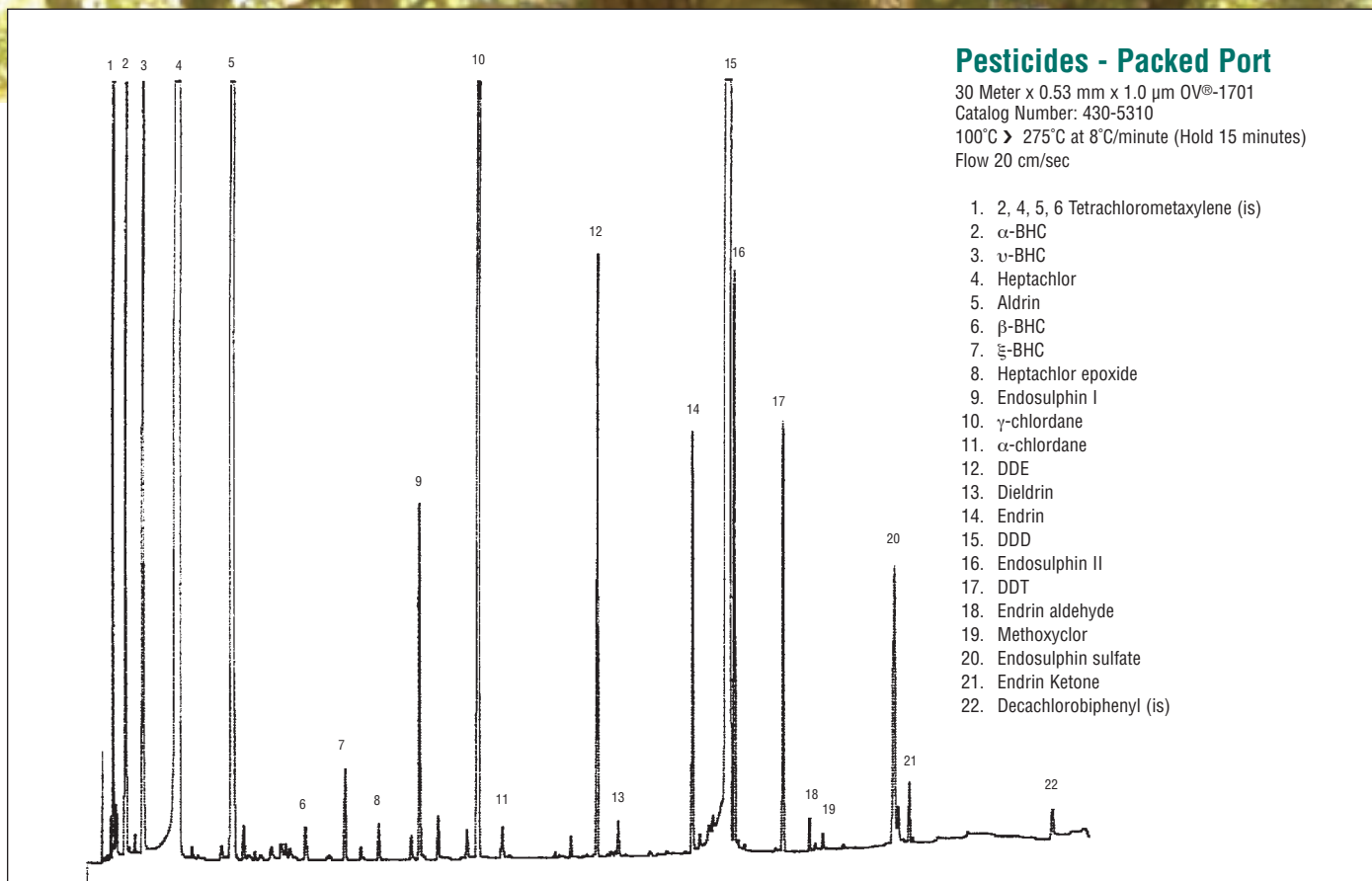

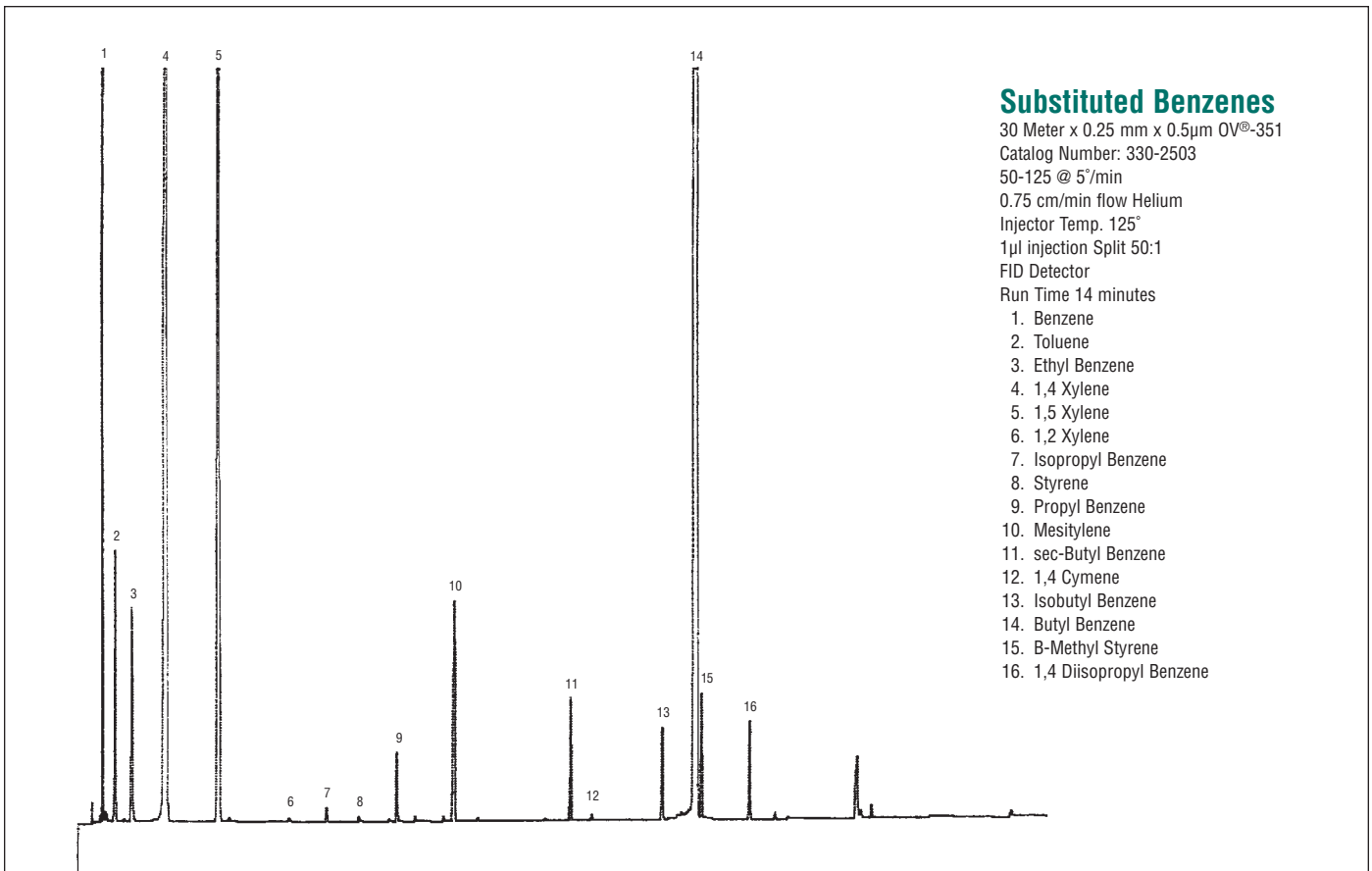
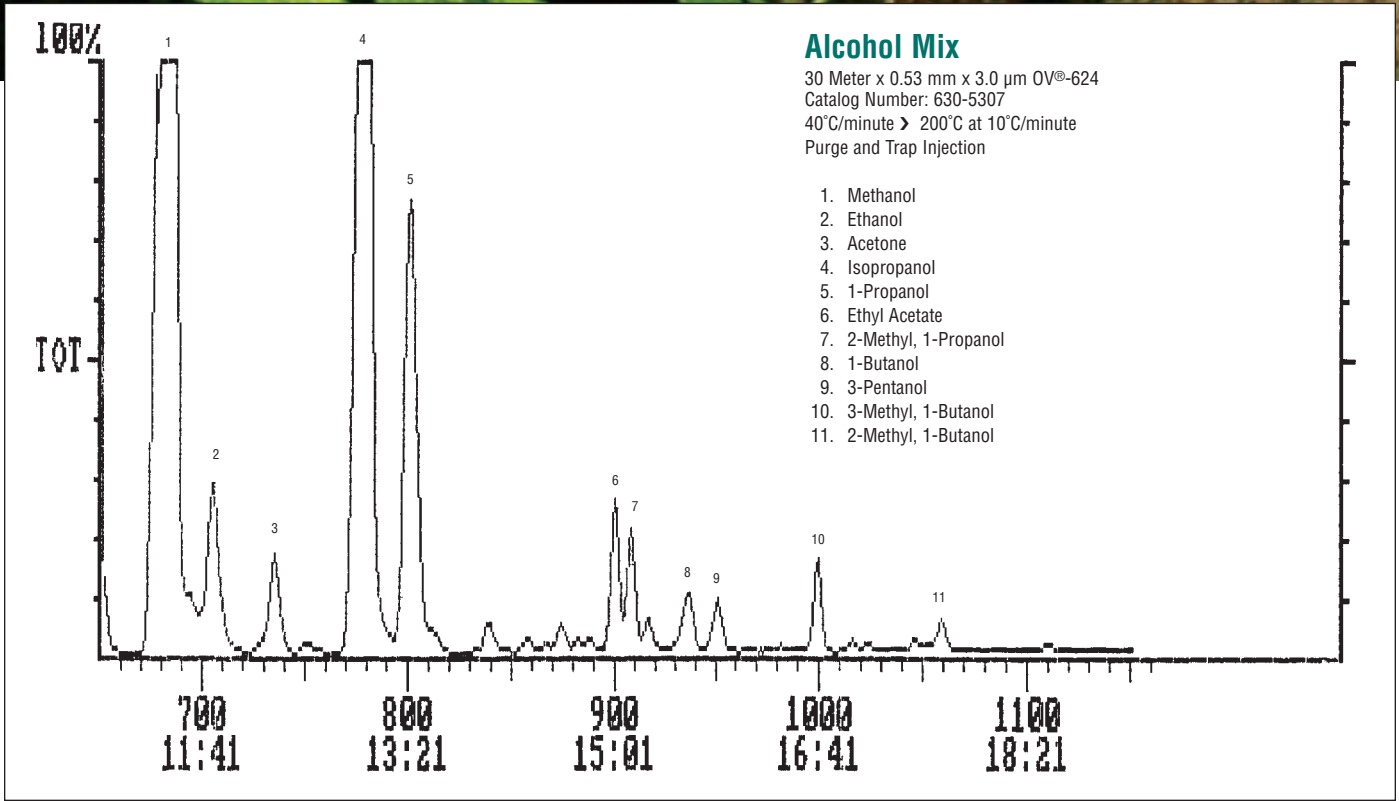

Conjugated Estrogens

15 Meter x 0.25 mm OV[®]-225, 0.25 Micron Film
Catalog Number: 715-2502

Carrier Gas: Helium

Oven: 210°C Isothermal

Injector: 260°C, Detector: 260°C F.I.D.

Split Injection: 1:20

Instrument: CARLO ERBA

1. 17 α -Estradiol
2. 17 α -Dihydroequilin
3. Estrone
4. Equilin
5. Estrone methyl ether

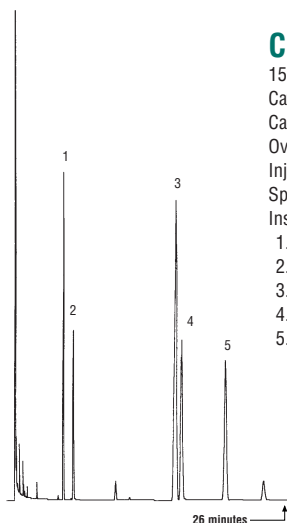

Solvent Mix

60 Meter x 0.32 mm x 0.5 μ m OV[®]-5
Catalog Number: 560-3203

0.1 μ l Slit 50:1

30°C (Hold 5 minutes)

> 75°C at 2°C/minute

1. Methanol
2. Ethanol
3. Acetone
4. Isopropanol
5. 1-Propanol
6. Ethyl Acetate
7. 2-Methyl, 1-Propanol
8. 1-Butanol
9. 3-Pentanol
10. 3-Methyl, 1-Butanol
11. 2-Methyl, 1-Butanol

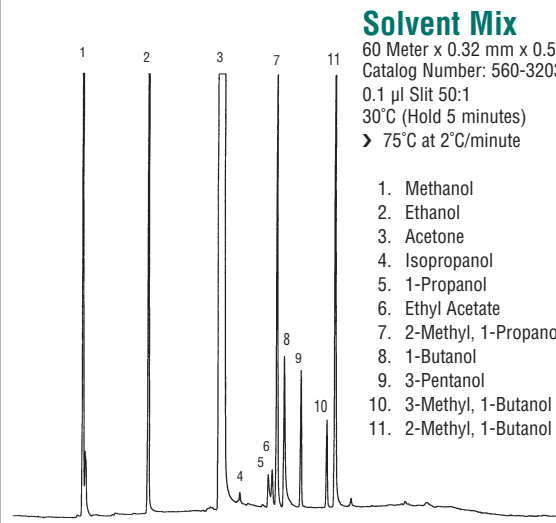

Bacterial Acid Methyl Esters

30 Meter x 0.25 mm OV[®]-1, 0.25 Micron Film

Catalog Number: 130-2502

150°C (Hold 4 minutes) > 250°C at 4°C/minute, F.I.D.

- | | |
|------------------------------------|--|
| 1. Methyl undecanoate | 12. Methyl palmitoleate |
| 2. Methyl 2-hydroxydecanoate | 13. Methyl palmitate |
| 3. Methyl laurate | 14. Methyl 14-methylhexadecanoate |
| 4. Methyl tridecanoate | 15. Me. di-cis-9, 10-methylene hexadecanoate |
| 5. Methyl 2-hydroxydodecanoate | 16. Methyl heptadecanoate |
| 6. Methyl 3-hydroxydodecanoate | 17. Methyl 2-hydroxyhexadecanoate |
| 7. Methyl myristate | 18. Methyl oleate |
| 8. Methyl 12-methyltetradecanoate | 19. Methyl stearate |
| 9. Methyl pentadecanoate | 20. Me. di-cis-9, 10-methylene octadecanoate |
| 10. Methyl 2-hydroxytetradecanoate | 21. Methyl nonadecanoate |
| 11. Methyl 3-hydroxytetradecanoate | 22. Methyl arachidate |

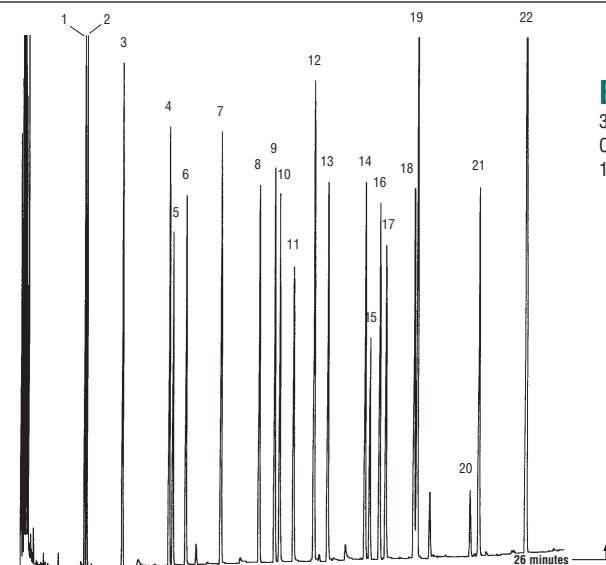

Phthalate Esters

30 Meter x 0.32 mm x 0.5 μ m OV[®]-5

Catalog Number: 530-3203

100°C > 275°C at 10°C/minute (Hold 10 minutes)

- | | |
|--------------------------------------|-------------------------------------|
| 1. Dimethyl phthalate | 9. Hexyl 2-ethylhexyl phthalate |
| 2. Diethyl phthalate | 10. Di-n-hexyl phthalate |
| 3. Di-isobutyl phthalate | 11. Butylbenzyl phthalate |
| 4. Di n-butyl phthalate | 12. bis (2-n-butoxyethyl) phthalate |
| 5. bis (methoxyethyl) phthalate | 13. Dicyclohexyl phthalate |
| 6. bis (4-methyl-2-pentyl) phthalate | 14. bis (2-ethylhexyl) phthalate |
| 7. bis (ethoxyethyl) phthalate | 15. Di-nonyl phthalate |
| 8. Di-amyl phthalate | 16. Di-nonyl phthalate |

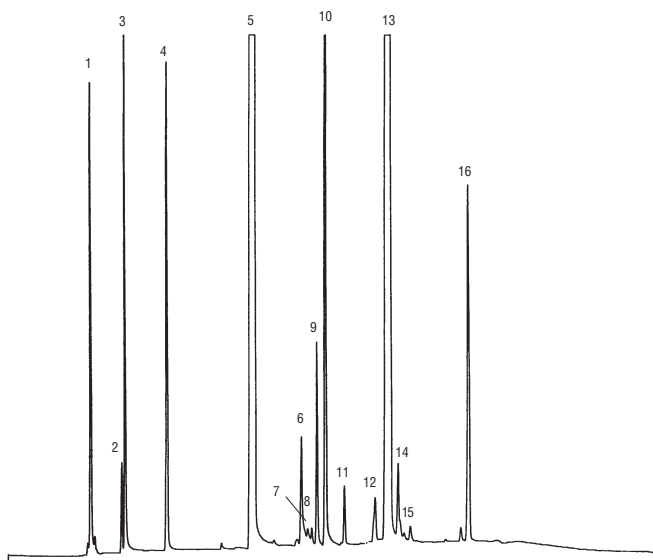

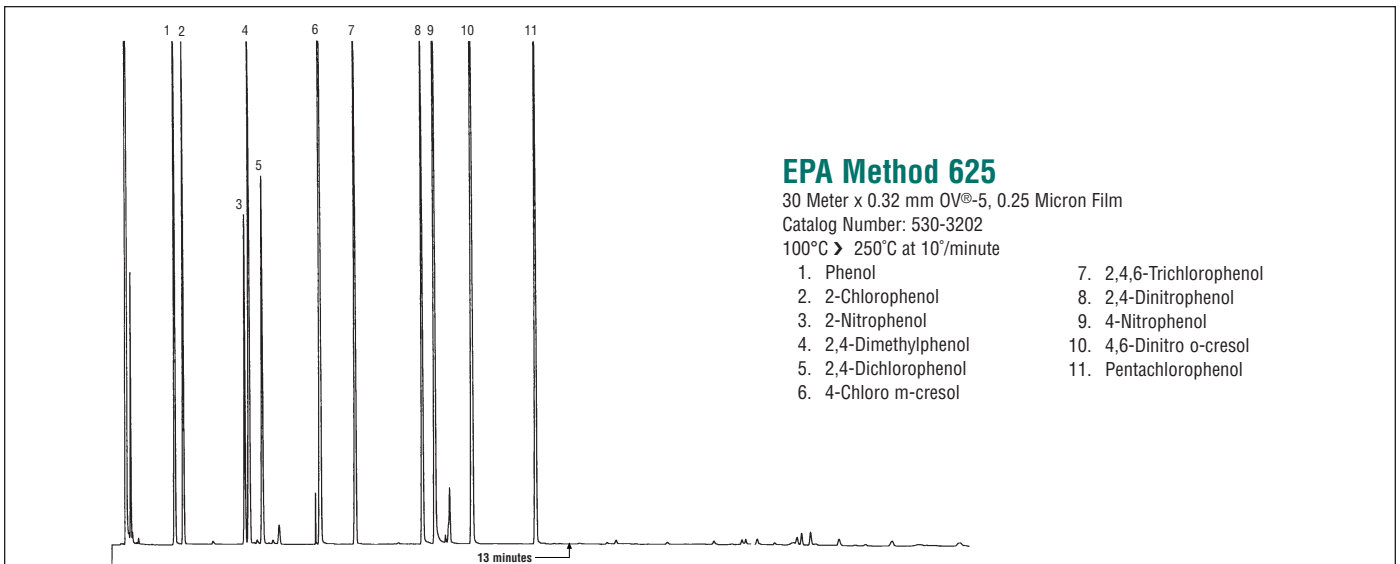
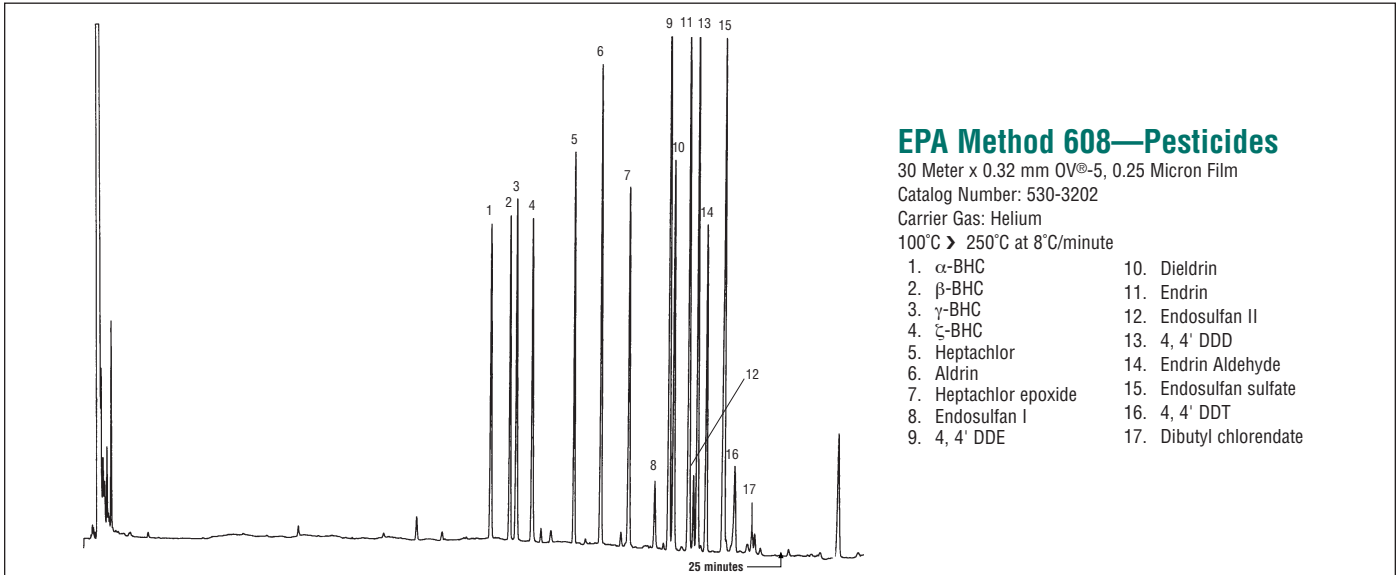
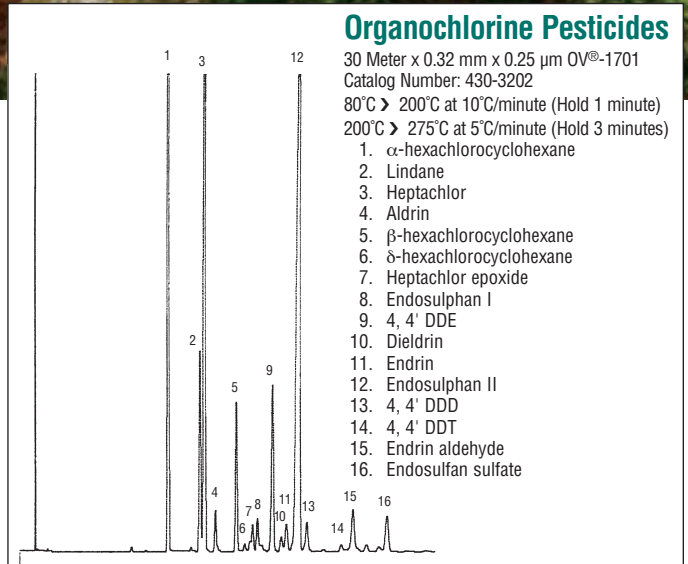
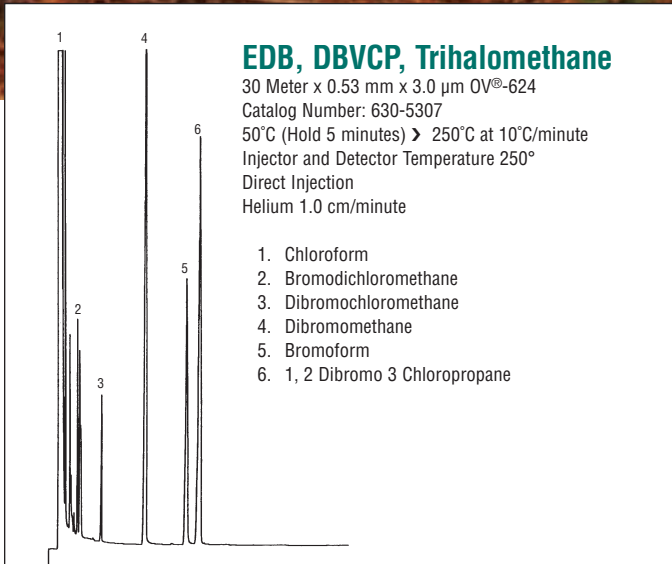

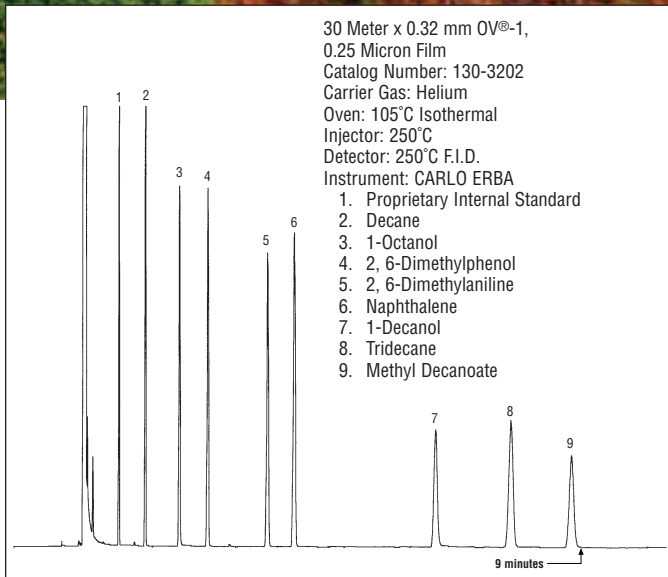

Spearmint Oil

30 Meter x 0.32 mm OV[®]-5, 0.5 Micron Film, Catalog Number: 530-3203
60°C > 250°C at 4°C/minute

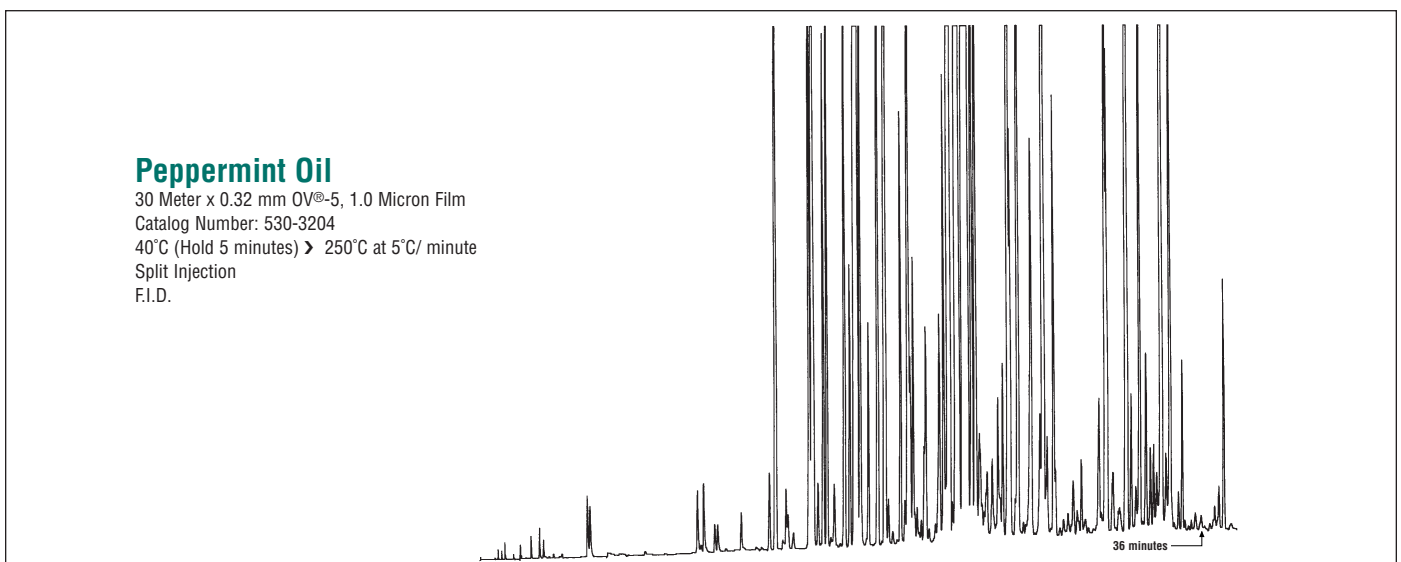
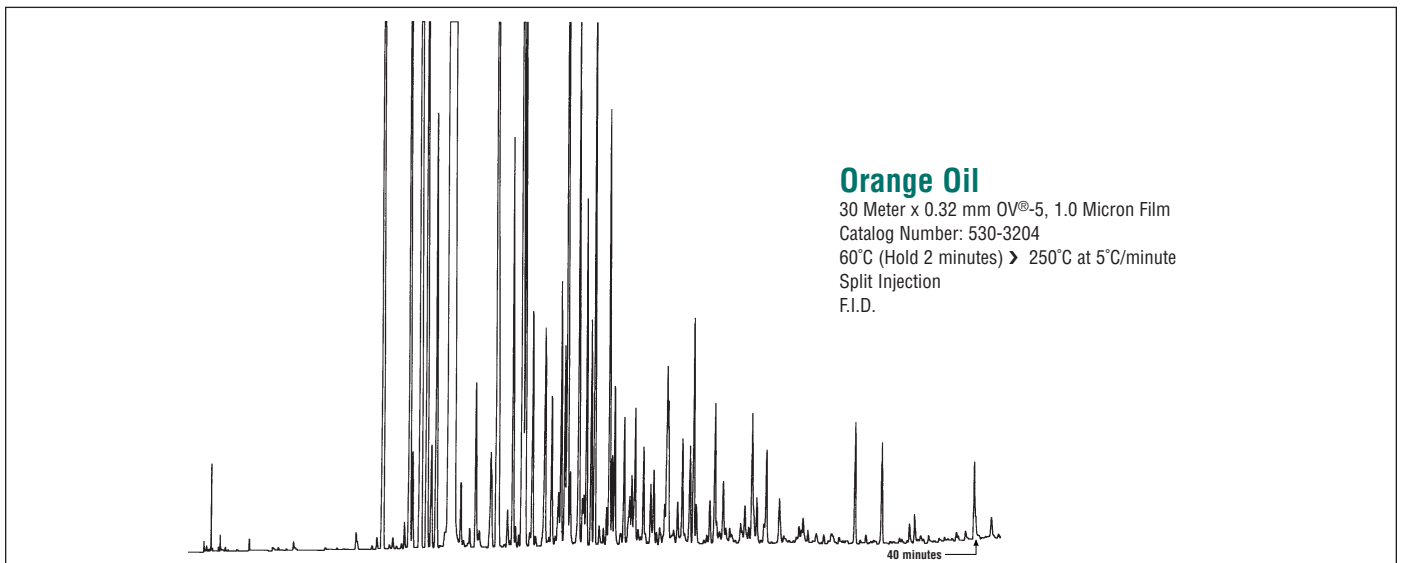
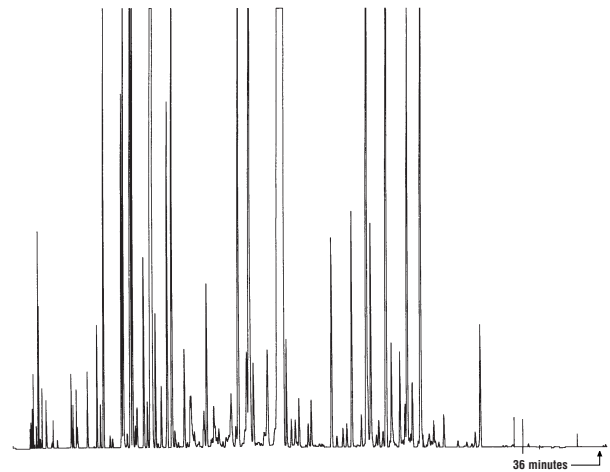

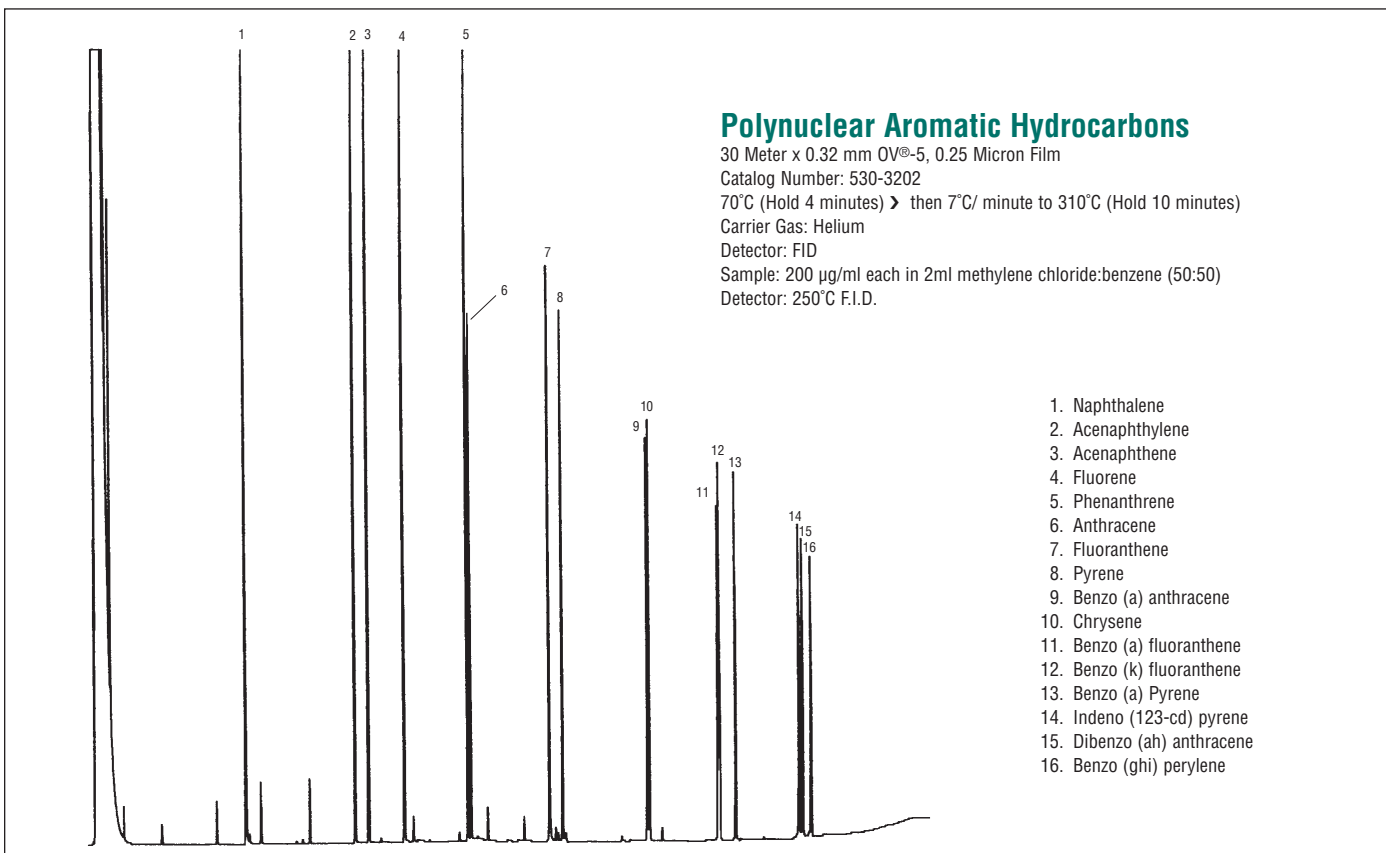
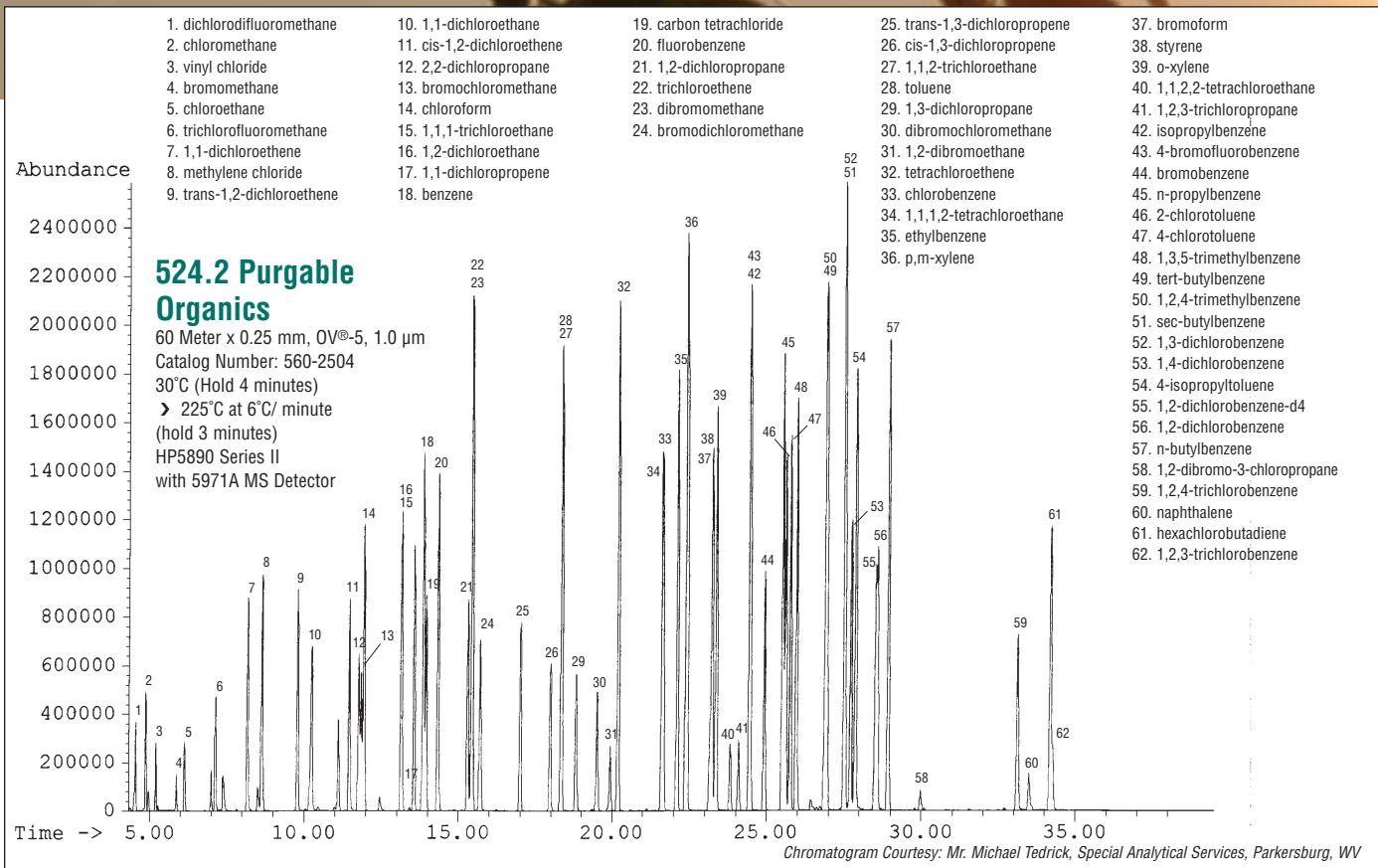

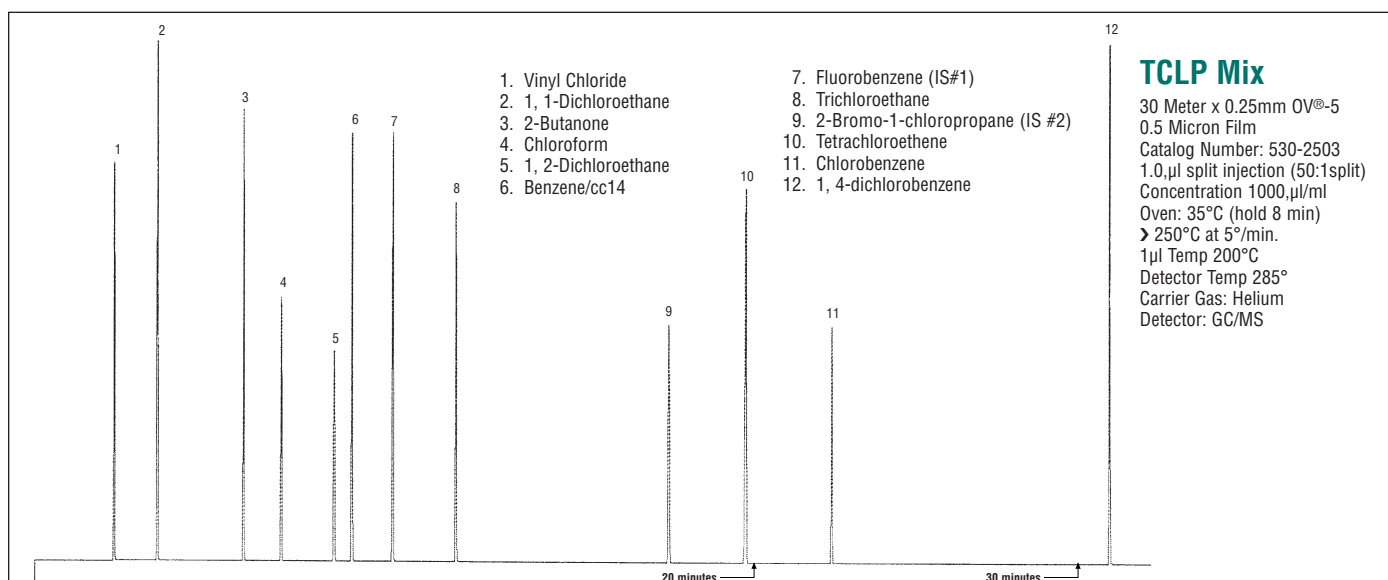
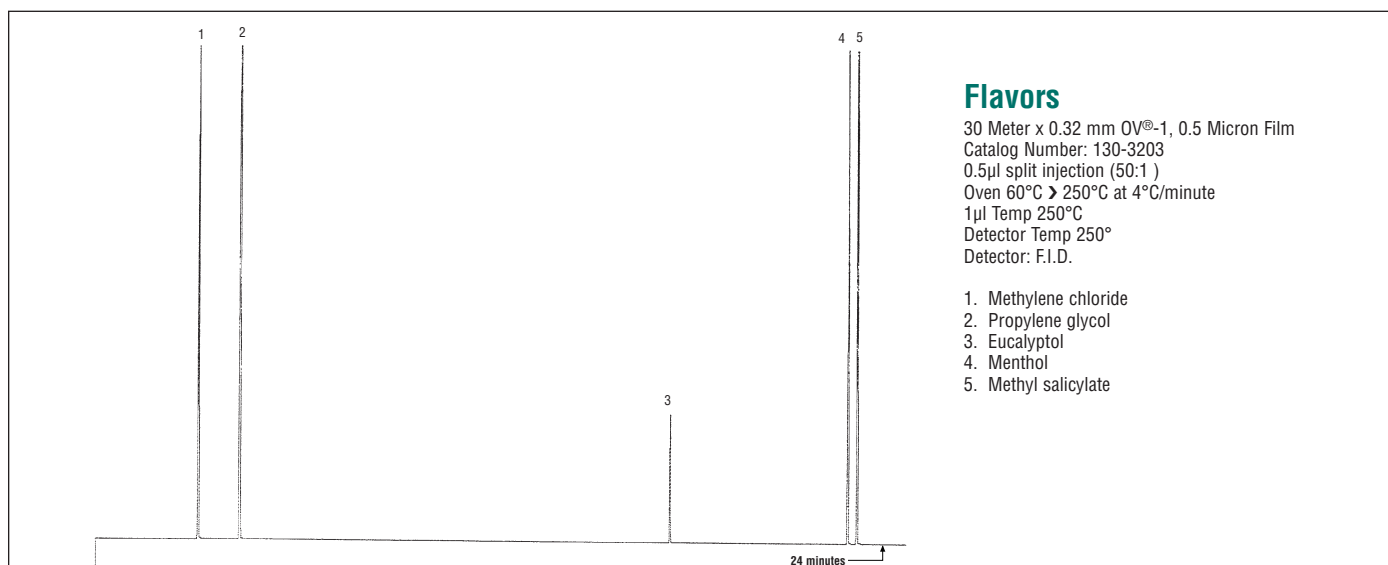
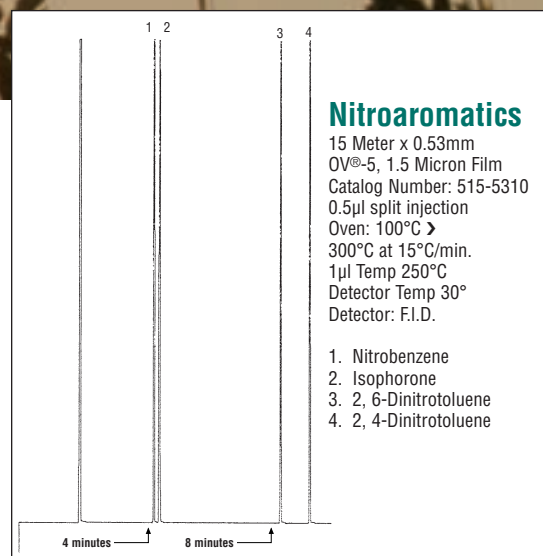
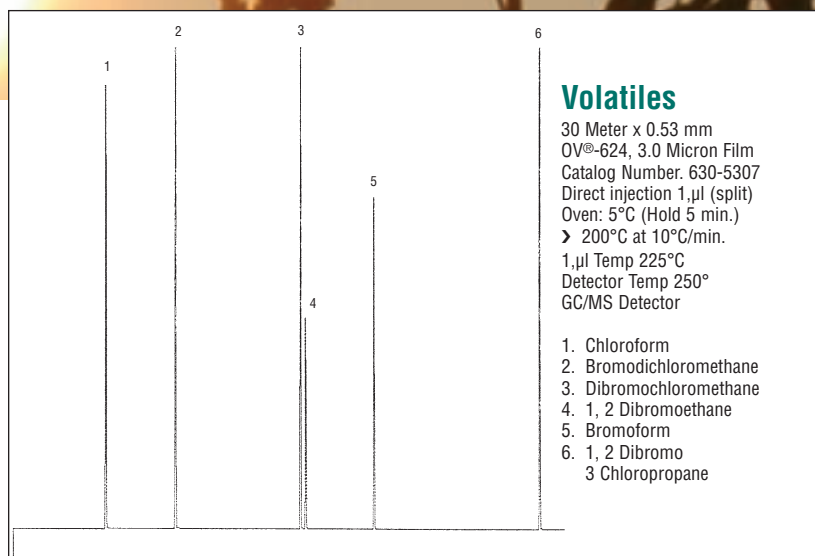

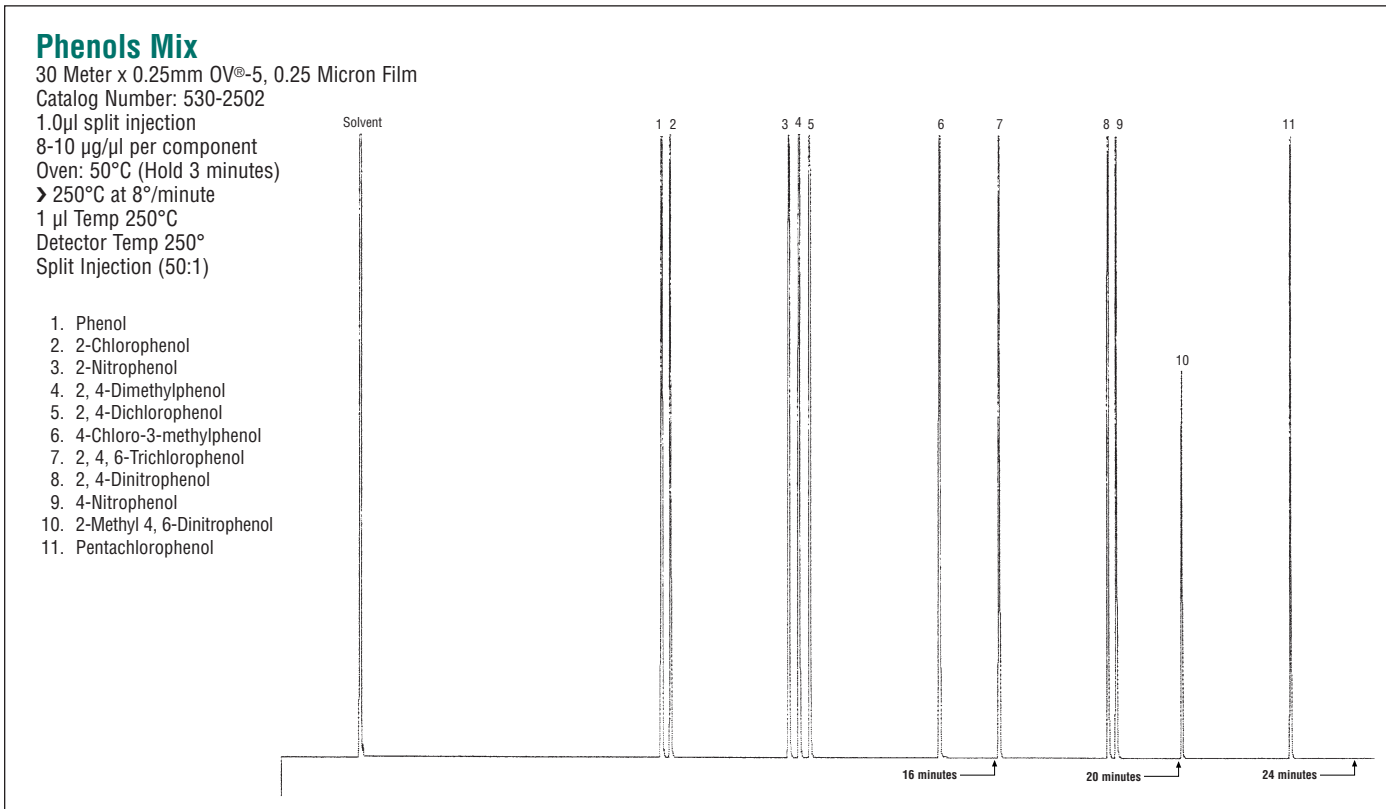
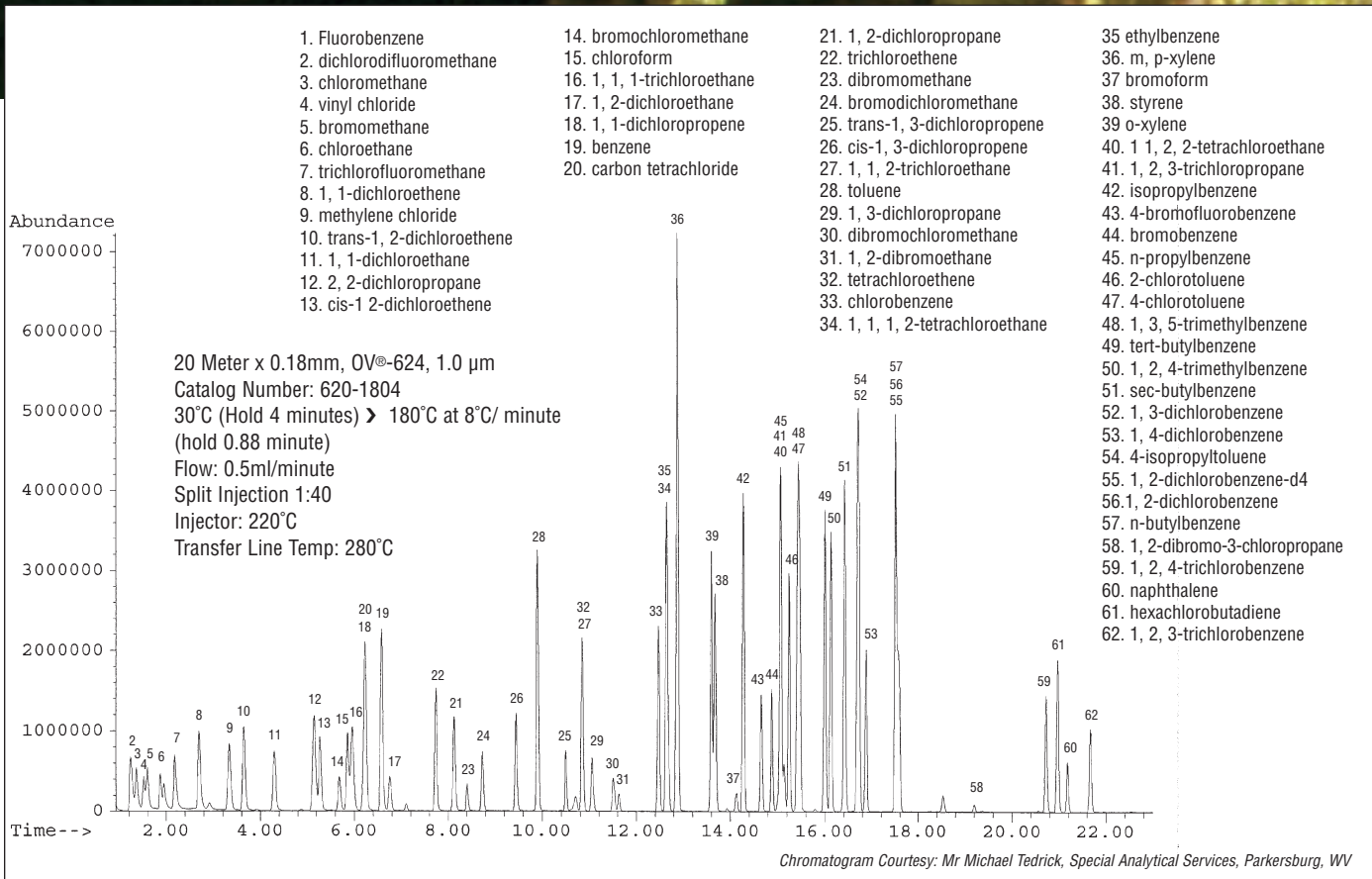

Gasoline

30 Meter x 0.32mm OV[®]-5, 1.0 Micron Film, Catalog Number: 530-3204
 40°C (Hold 6 minutes) > 250°C at 5°C/minute (At 250°C, hold 70 minutes)
 Injection Temperature 250°C, Detector Temperature 275°C, Detector F.I.D.

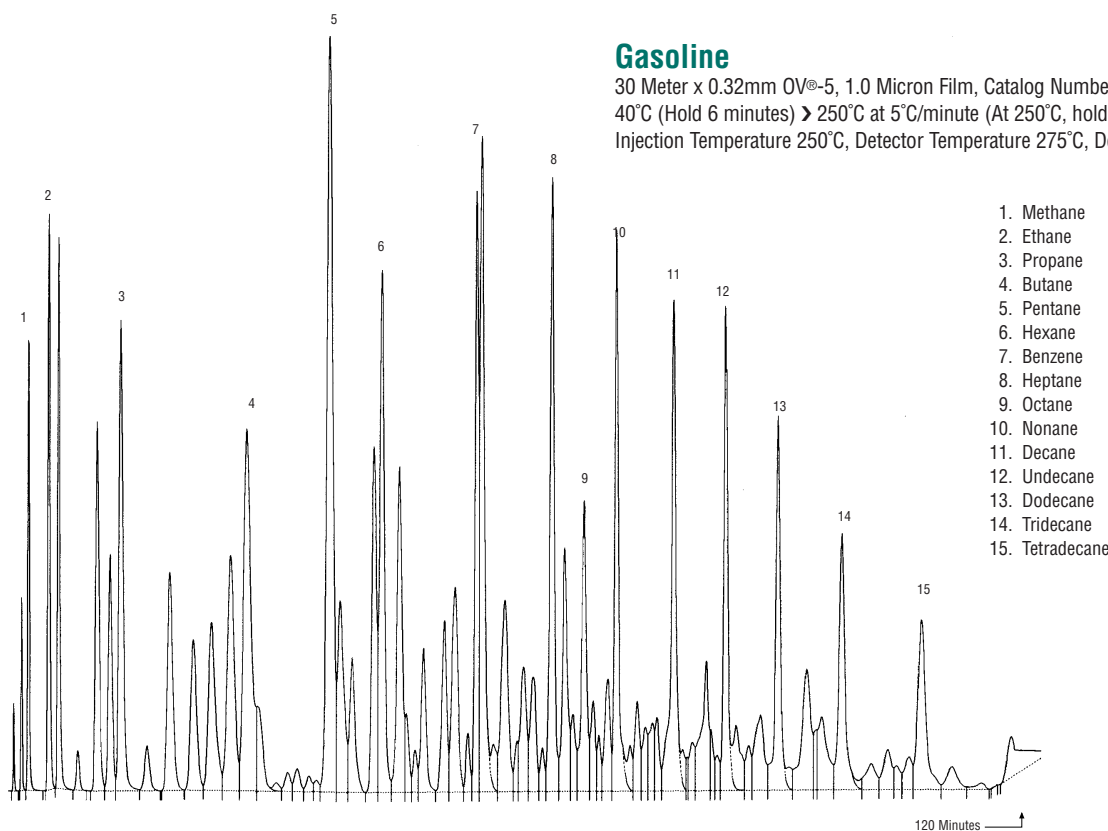

1. Methane
2. Ethane
3. Propane
4. Butane
5. Pentane
6. Hexane
7. Benzene
8. Heptane
9. Octane
10. Nonane
11. Decane
12. Undecane
13. Dodecane
14. Tridecane
15. Tetradecane

Diesel Range Organics Mix

30 Meter x 0.25mm OV[®]-5, 1.0 Micron Film, Catalog Number: 530-2504
 100°C > 340°C at 15°C/minute (Hold 10 minutes)
 Injection Temperature 250°C, Detector Temperature 340°C, Detector F.I.D.

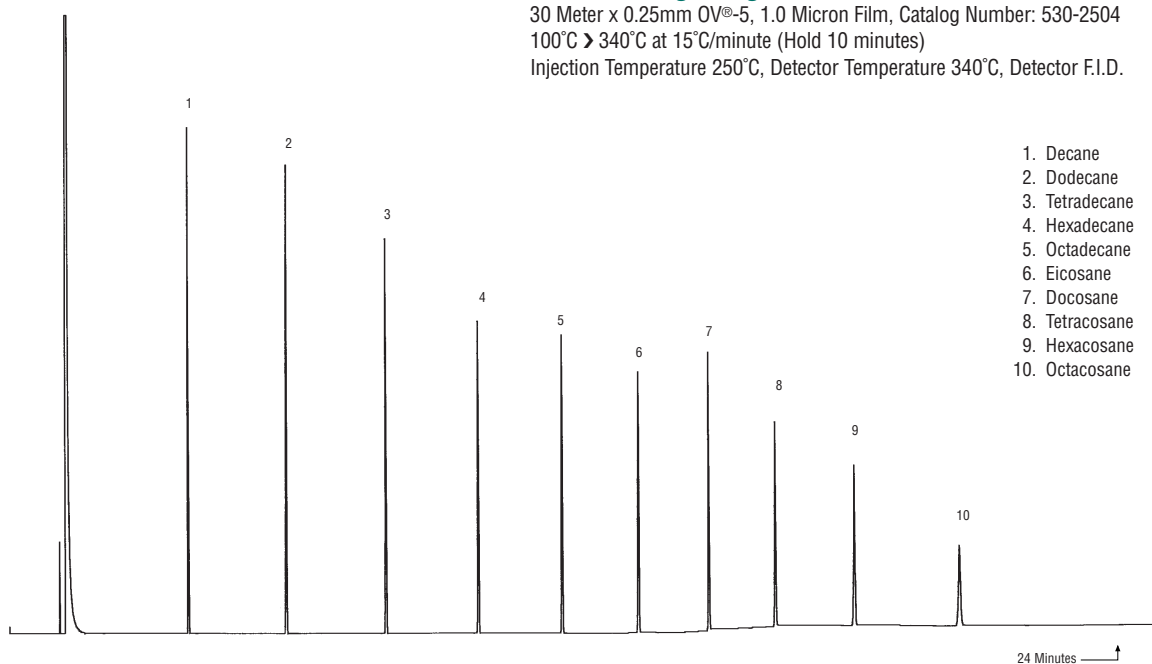

1. Decane
2. Dodecane
3. Tetradecane
4. Hexadecane
5. Octadecane
6. Eicosane
7. Docosane
8. Tetracosane
9. Hexacosane
10. Octacosane

EPA Method 606 Phthalates

30 Meter x 0.25 mm OV[®]-5, 0.50 Micron Film
 Catalog Number: 530-2503
 200°C > 310°C at 13°C/minute (Hold 15 minutes)
 Injection Temperature 300°C
 Detector Temperature 320°C, Detector F.I.D.

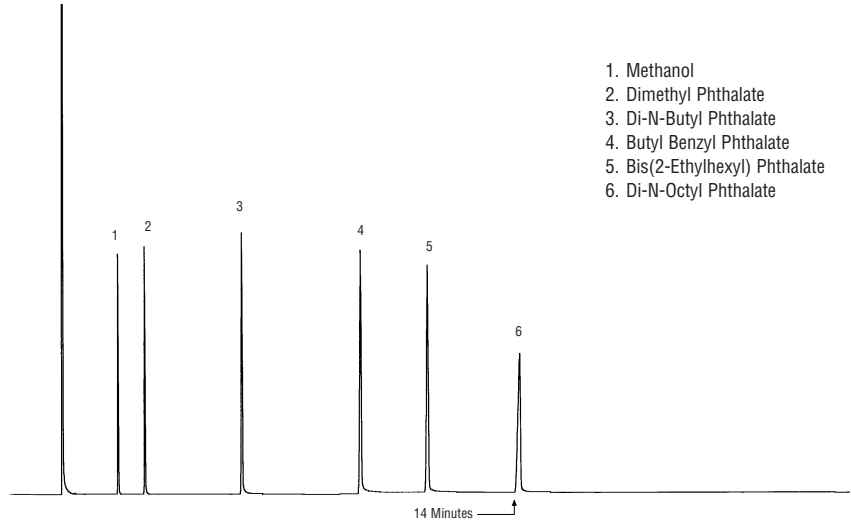

1. Methanol
2. Dimethyl Phthalate
3. Di-N-Butyl Phthalate
4. Butyl Benzyl Phthalate
5. Bis(2-Ethylhexyl) Phthalate
6. Di-N-Octyl Phthalate

EPA Method 611 Halocarbons

30 Meter x 0.25 mm OV[®]-5, 0.50 Micron Film, Catalog Number: 530-2503
 Temperature Program 100°C > 250°C at 15°C/minute
 Injection Temperature 250°C
 Detector Temperature 300°C, Detector F.I.D.

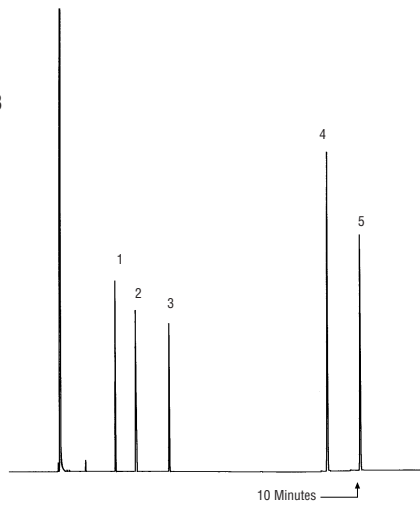

1. Bis (2-Chloroethyl) Ether
2. Bis (2-Chloroisopropyl) Ether
3. Bis (2-Chloroethoxy) Methane
4. 4-Chlorophenyl Phenyl Ether
5. 4-Bromophenyl Phenyl Ether

EPA Method 612 Chlorinated Hydrocarbons

30 Meter x .025 mm OV[®]-5, 0.50 Micron Film
 Catalog Number: 530-2503
 Temperature Program 40°C > 250°C at 10°C/minute
 Injection Temperature 300°C
 Detector Temperature 350°C, Detector F.I.D.

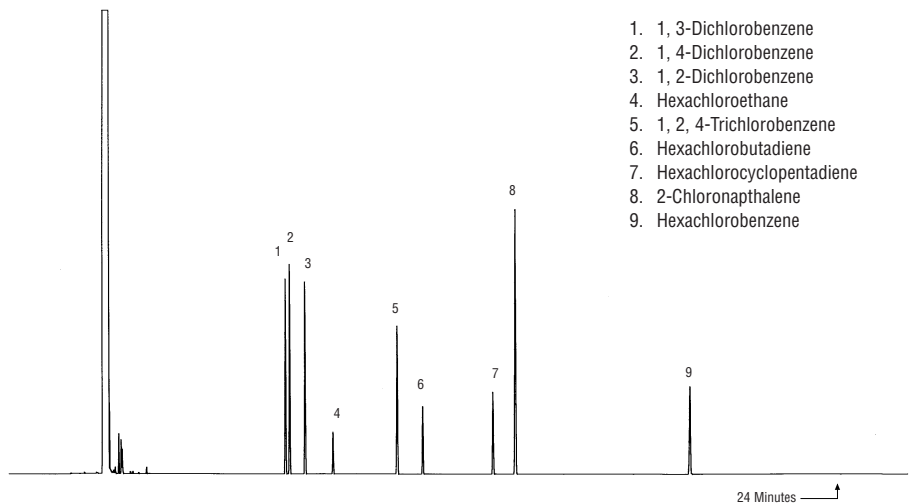

1. 1, 3-Dichlorobenzene
2. 1, 4-Dichlorobenzene
3. 1, 2-Dichlorobenzene
4. Hexachloroethane
5. 1, 2, 4-Trichlorobenzene
6. Hexachlorobutadiene
7. Hexachlorocyclopentadiene
8. 2-Chloronaphthalene
9. Hexachlorobenzene

Solvents

30 Meter x 0.32mm OV[®]-5, 0.50 Micron Film, Catalog Number: 530-3203
50°C Isothermal

Injection Temperature 200°C, Detector Temperature 225°C, Detector F.I.D.

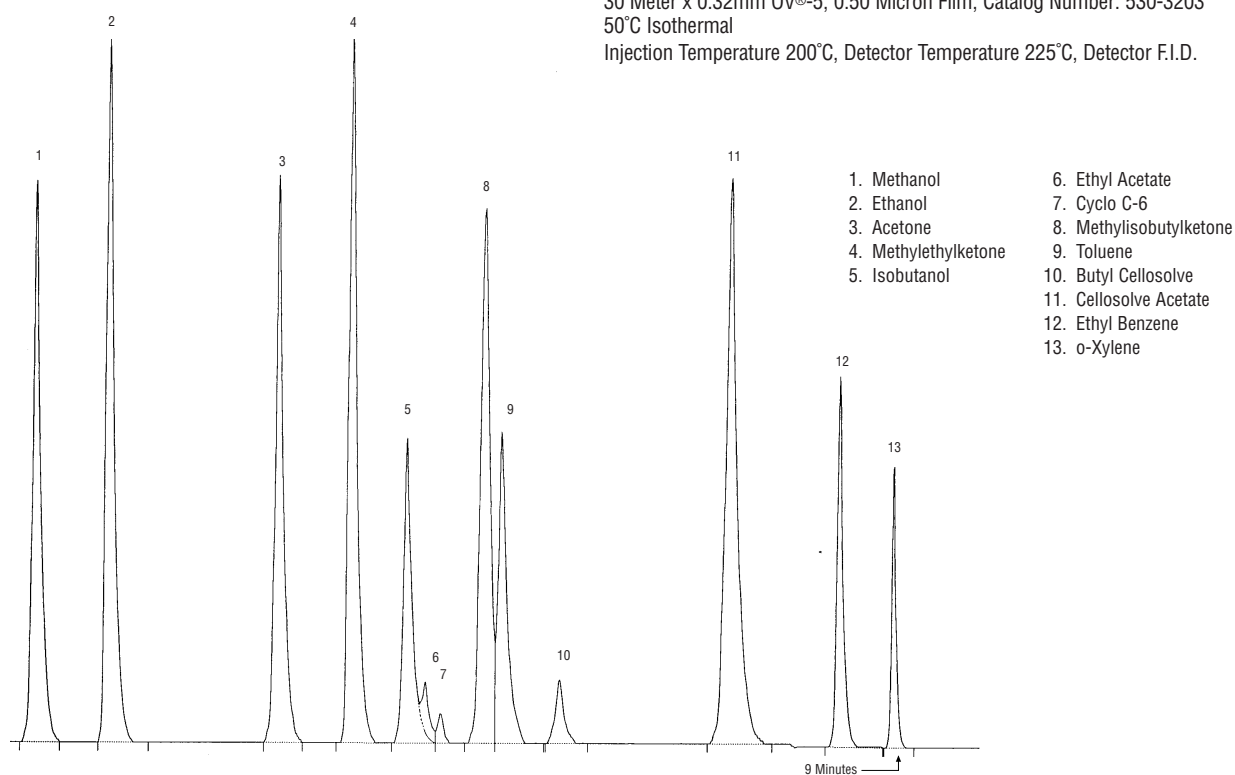

Pesticides

30 Meter x 0.32mm OV[®]-5, 0.5 Micron Film, Catalog Number: 530-3203

150°C > 300°C at 4°C/minute

Injection Temperature: 250°C, Detector Temperature: 300°C, Detector: E.C.D.

1. Alpha-BHC
2. Gamma-BHC
3. Beta-BHC
4. Delta-BHC
5. Heptachlor
6. Aldrin
7. Heptachlor Epoxide
8. Gamma-Chlordane
9. Alpha-Chlordane
10. 4,4'-DDE
11. Endosulfan 1
12. Dieldrin
13. Endrin
14. 4,4'-DDD
15. Endosulfan II
16. 4,4'-DDT
17. Endrin Aldehyde
18. Methoxychlor
19. Endosulfan Sulfate
20. Endrin Ketone

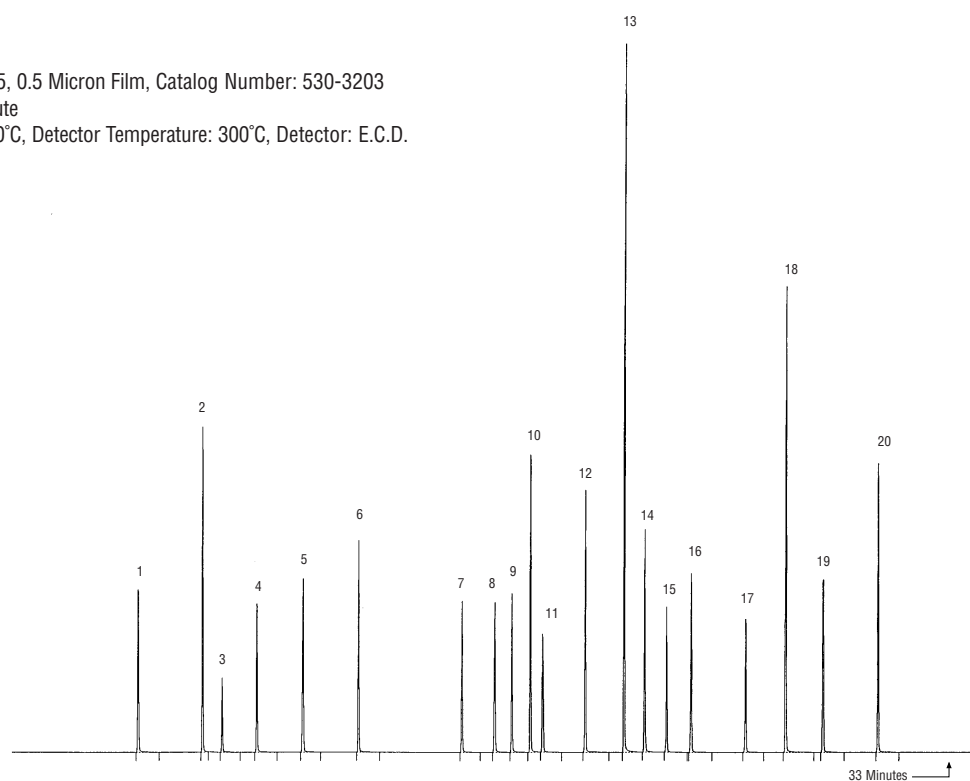

Volatile Organic Compounds (VOC)

30 Meter x 0.32mm OV®-624, 1.8 Micron Film
 Catalog Number: 630-3207
 Temperature Program 40°C (Hold 1 minute)
 > 140°C at 10°C/minute
 Injection Temperature 250°C, Split 1:40
 Detector MSD Transfer 275°C

1. 1,1-Dichloroethene
2. Methylene Chloride
3. 2-Butanone (MEK)
4. Chloroform
5. 1,2-Dichloroethane
6. Benzene
7. Carbon Tetrachloride
8. Trichloroethene
9. Pyridine
10. Tetrachloroethene
11. Chlorobenzene

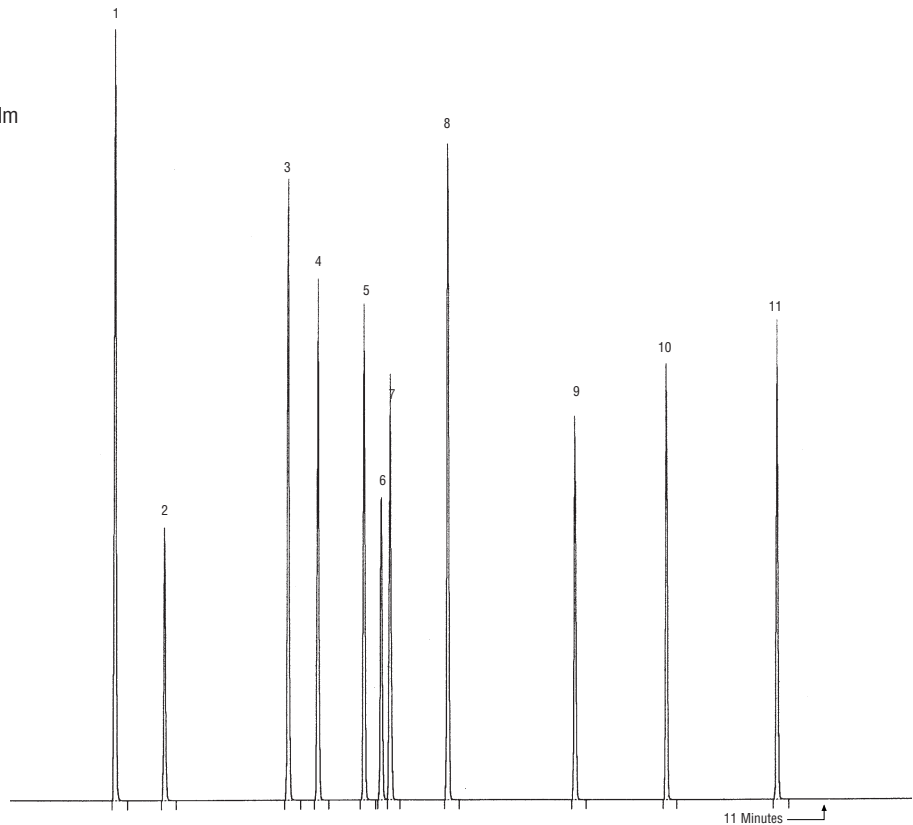

Alcohols/Hydrocarbons

30 Meter x 0.53mm OV®-1, 1.0 Micron Film, Catalog Number: 130-5304
 Carrier Gas: Helium
 Injection Temperature 30°C (Hold 1 minute) > 200°C at 20°C/minute
 Split 100:1, 250µl, Detector F.I.D.

1. Methane
2. Ethylene
3. Ethane
4. Propylene
5. Propane
6. Propadiene
7. Iso-Butane
8. Methanol
9. Iso-Butene
10. N-Butane
11. Cis-2-Butene
12. Ethanol
13. Iso-Propanol
14. N-Pentane
15. Tert-Butanol
16. N-Propanol
17. Methyl Tert-Butyl Ether
18. Sec-Butanol
19. N-Hexane
20. Iso-Butanol
21. N-Butanol
22. Benzene

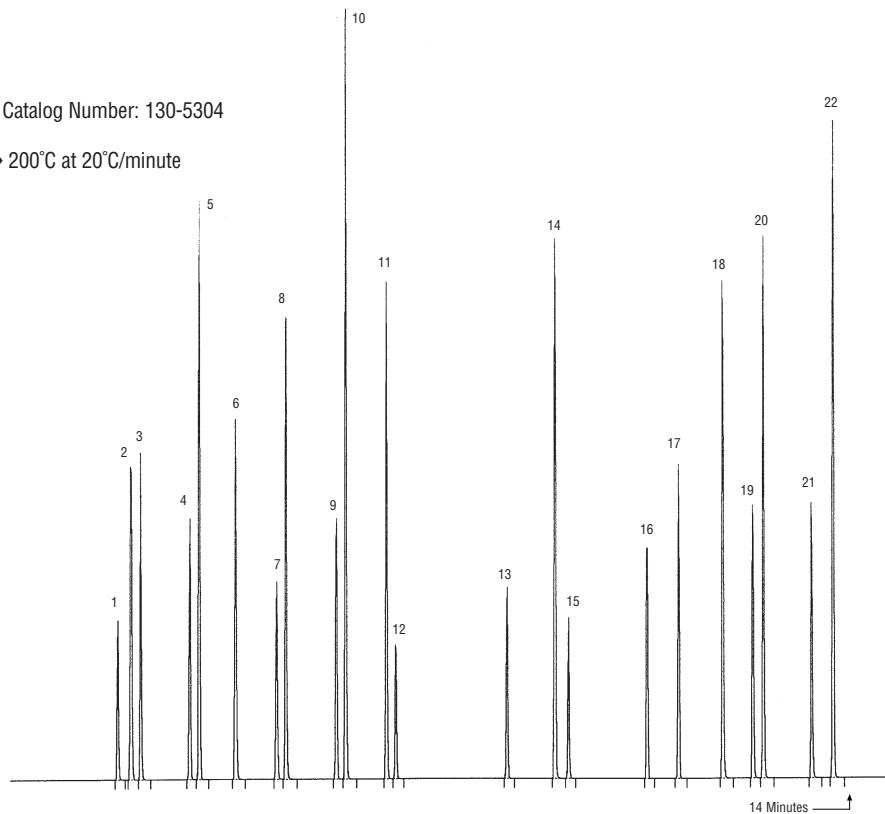

EPA Methods 8015/8030

30 Meter x 0.32mm OV[®]-624, 1.8 Micron Film, Catalog Number: 630-3207

35°C > 170°C at 15°C/minute

Injection Temperature 250°C, Split 1:50, Detector MSD Transfer 275°C

1. Ethanol
2. Diethyl Ether
3. Acrolein
4. Acetonitrile
5. Acrylonitrile
6. 2-Butanone (MEK)
7. Methyl Isobutyl Ketone (MIBK)
8. Paraldehyde
9. Acrylamide

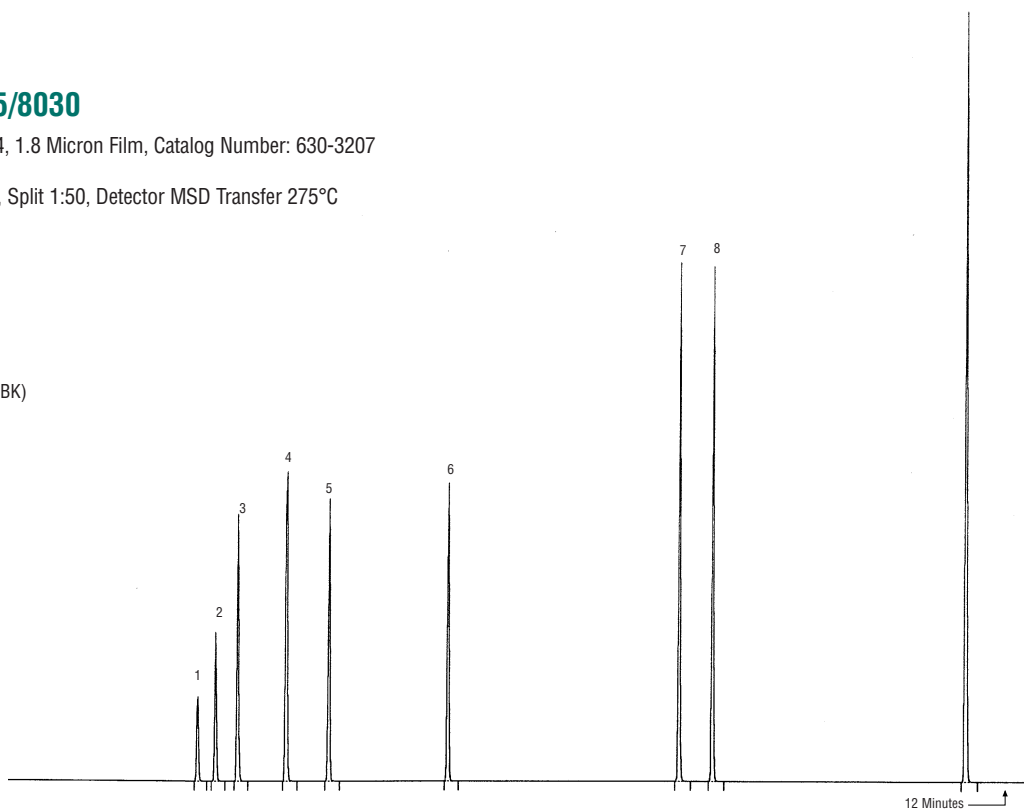

European Red List Volatiles

30 Meter x 0.25mm OV[®]-5, 0.5 Micron Film, Catalog Number: 530-2503

40°C > 140°C at 10°C/minute

Injection Temperature Split 1:50 - Headspace Injector

Detector Temperature 300°C, Detector F.I.D.

1. 1,1-Dichloroethylene
2. 1,1-Dichloroethane
3. Chloroform
4. 1,1,1-Trichloroethane
5. 1,2-Dichloroethane
6. Carbon Tetrachloride
7. Trichloroethylene
8. Tetrachloroethylene

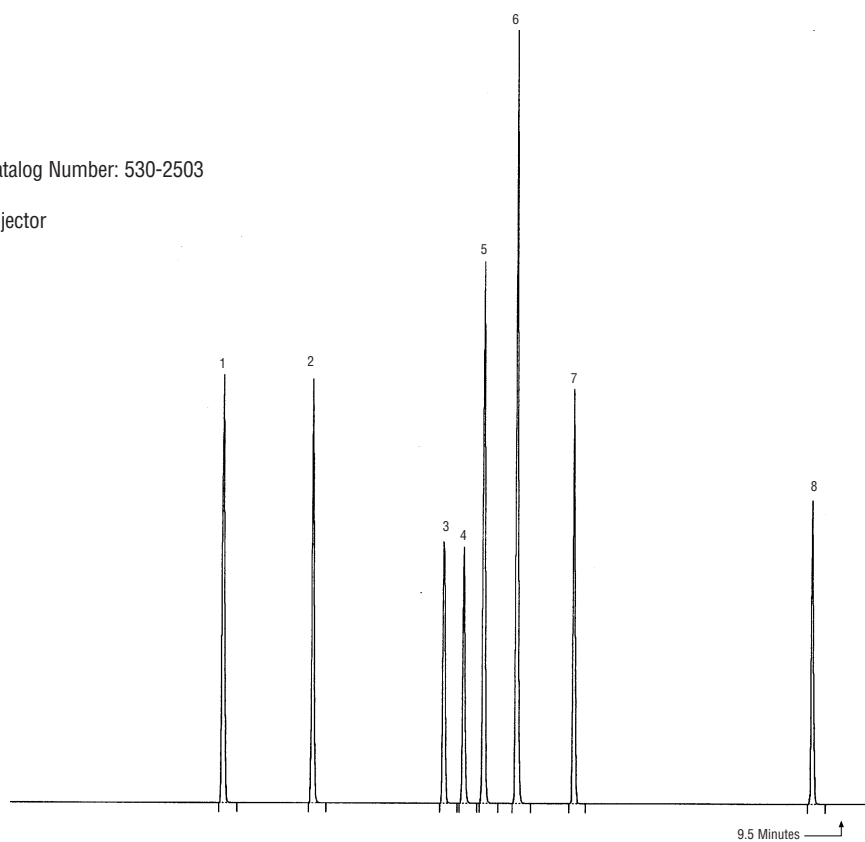

Pain Killers (Derivatized with BSTFA)

20 Meter x 0.18mm OV[®]-5, 0.4 Micron Film, Catalog Number: 520-1840

100°C > 250°C at 10°C/minute

Injection Temperature 250°C, Split 75:1, Detector Temperature 305°C, Detector F.I.D.

1. Nicotine
2. Aspirin
3. Ibuprofen
4. Acetaminophen
5. Caffeine

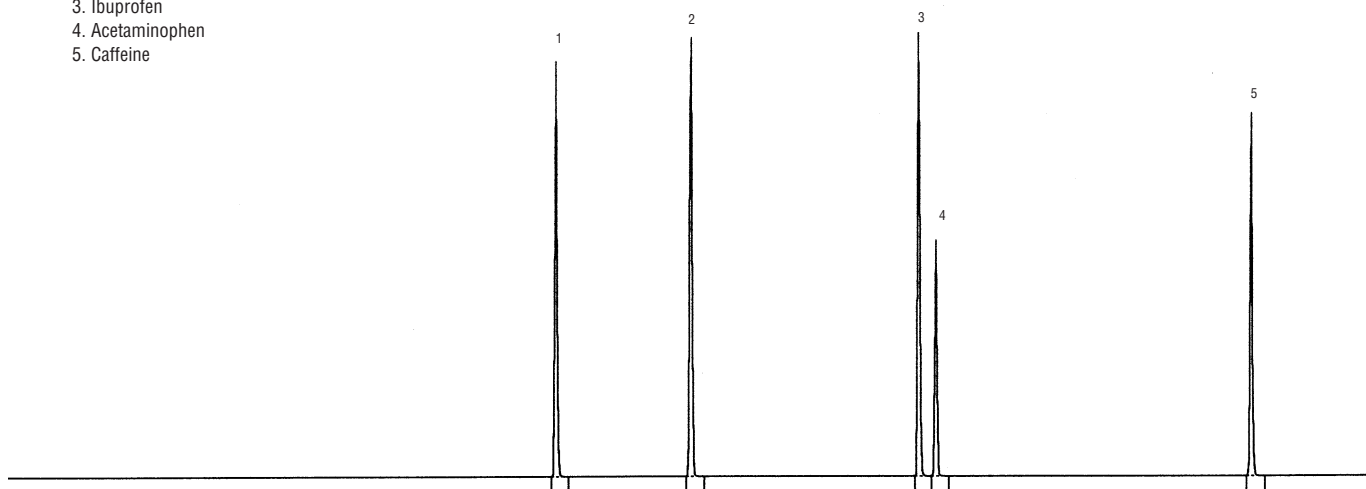

Nitrogen Based Solvents

30 Meter x 0.53mm OV[®]-1, 1.0 Micron Film, Catalog Number: 130-5304

Temperature Program 40°C (Hold 1 minute) > 250°C at 10°C/minute

Carrier Gas: Helium

Injection Temperature 250°C, Split 20:1, Detector Temperature 300°C

1. Acetonitrile
2. Acrolein
3. Acrylonitrile
4. Propionitrile
5. Methacrolein
6. Methacrylonitrile
7. Triethylamine
8. Ethyl Acrylate
9. Pyridine
10. Dimethylformamide (DMF)
11. Dimethylsulfoxide (DMSO)
12. Benzonitrile
13. 1-Methyl-2-Pyrrolidinone

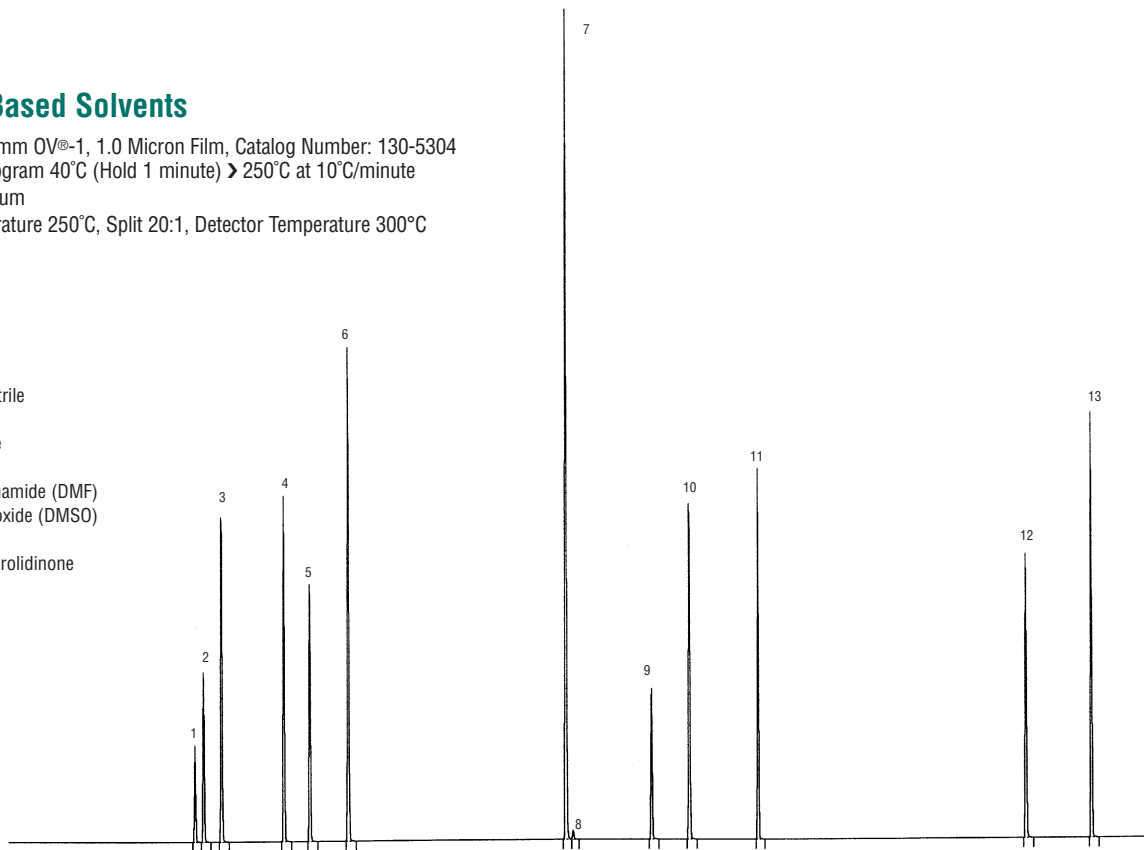

Organophosphorus Pesticides

30 Meter x 0.53 mm OV[®]-624, 3.0 Micron Film, Catalog Number: 630-5307
 125°C (Hold 5 minutes) ▶ 250°C at 5°C/minute
 Helium at 30 cm/second

1. Mevinphos
2. Demeton-O
3. Phorate
4. Demeton-S
5. Monocrotophos
6. Disulfoton
7. Methyl parathion
8. Merphos
9. Ethyl parathion
10. Fenthion
11. Fensulfothion

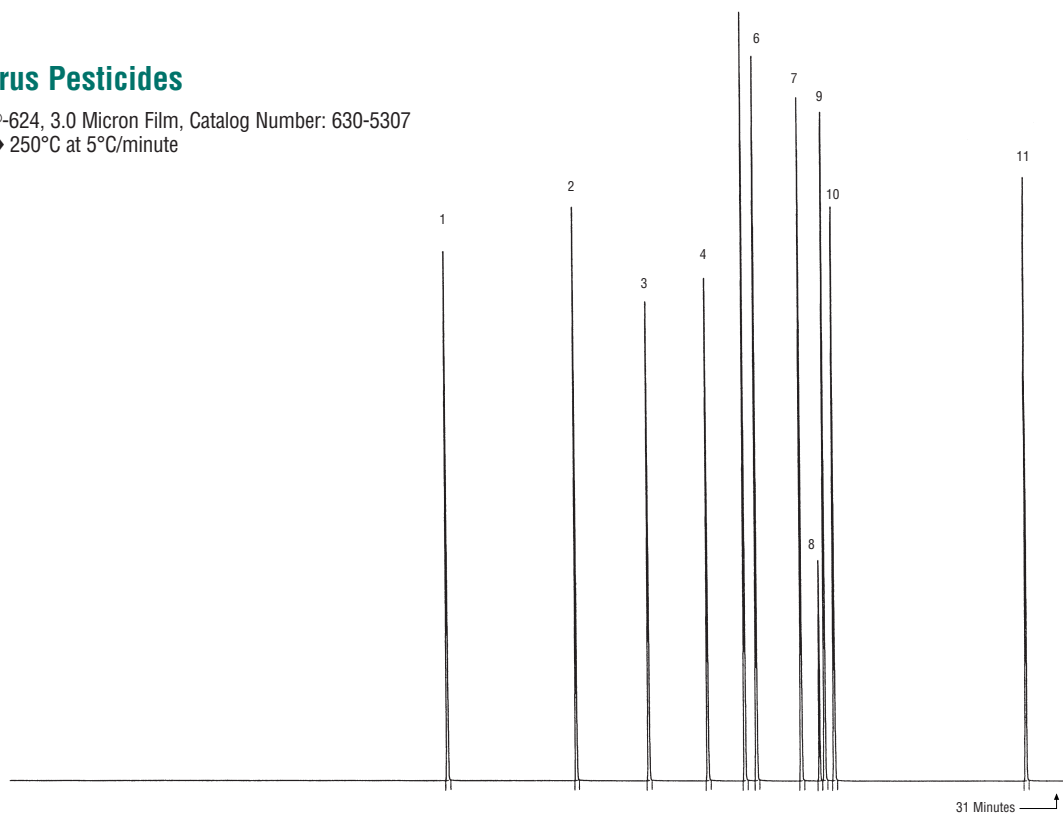

Sugars (As Alditol Acetates)

15 Meter x 0.32 mm, OV[®]-225, 0.50 Micron Film, Catalog Number: 715-3203
 Oven: 200°C (Hold 2 minutes) ▶ 250°C at 10°C/minute (Hold 10 minutes)
 Injection Temperature 275°C
 Detector Temperature 300°C

1. Rhamnitol
2. Fucitol
3. Ribitol
4. Arabinitol
5. Mannitol
6. Galactitol
7. Glucitol
8. Inositol

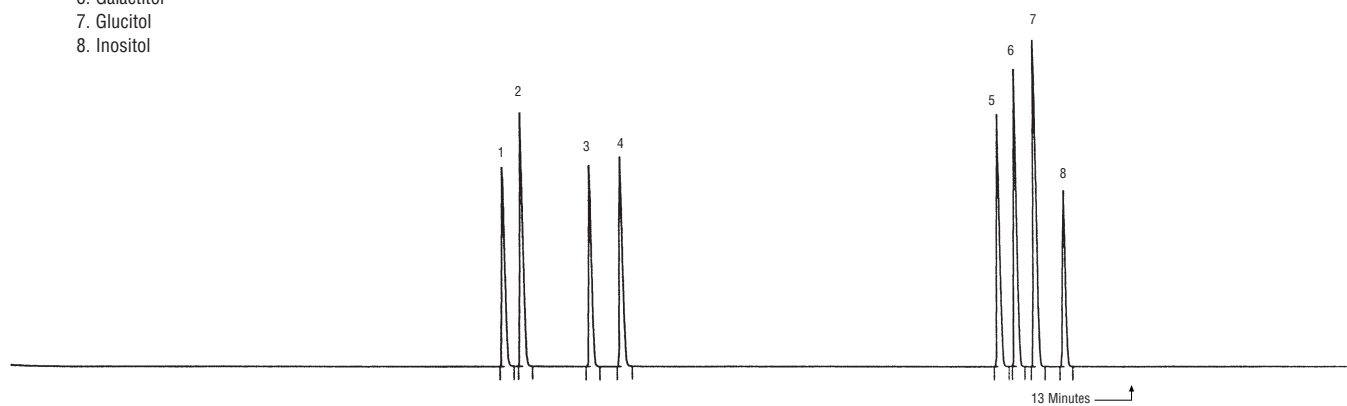

Aldehydes

30 Meters x 0.32 mm, OV®-624, 1.8 Micron Film, Catalog Number: 630-3207
 50°C > 200°C at 10°C/minute
 Injection Temperature 250°C
 Detector Temperature 250°C

1. Ethanol
2. Propanol
3. Butanol
4. Pentanol
5. Hexanol
6. Heptanol
7. Octanol
8. Nonanol
9. Decanol
10. Undecanol

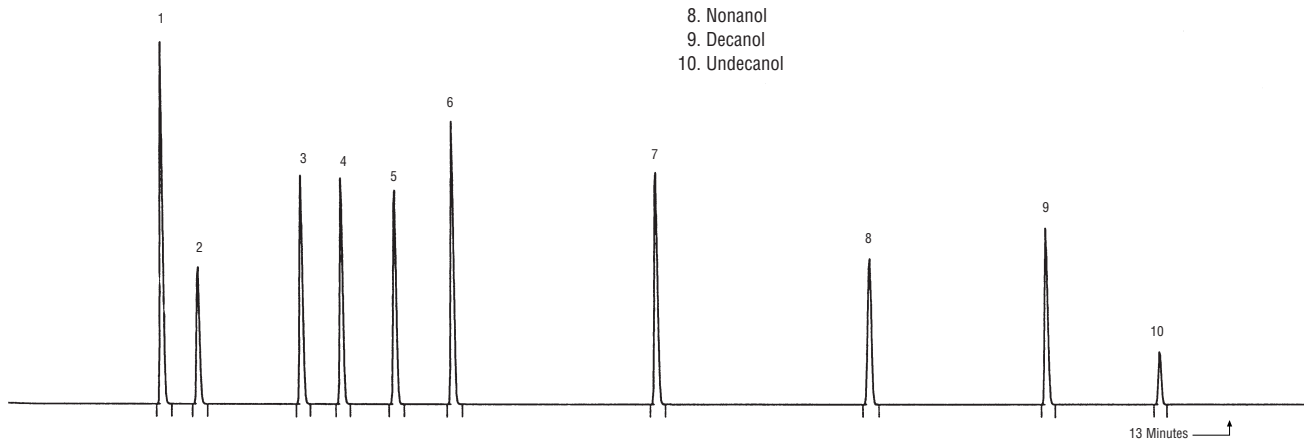

Volatile Organic Compounds (VOC) Purge & Trap

30 Meter x 0.53 mm OV®-624, 3.0 Micron Film
 Catalog Number: 630-5307
 Oven: 40°C (Hold 5 minutes) > 240°C at 10°C/minute
 Injection Temperature 250°C
 Detector Temperature 270°C, Detector F.I.D.

1. 1,1-Dichloroethene
2. Methylene Chloride
3. 1,1-Dichloroethane
4. Carbon Tetrachloride
5. Benzene
6. Trichloroethene
7. 1,2-Dichloropropane
8. 2-Chloroethyl Vinyl Ether
9. 1,1,2-Trichloroethane
10. Tetrachloroethene
11. Dibromochloromethane
12. Chlorobenzene

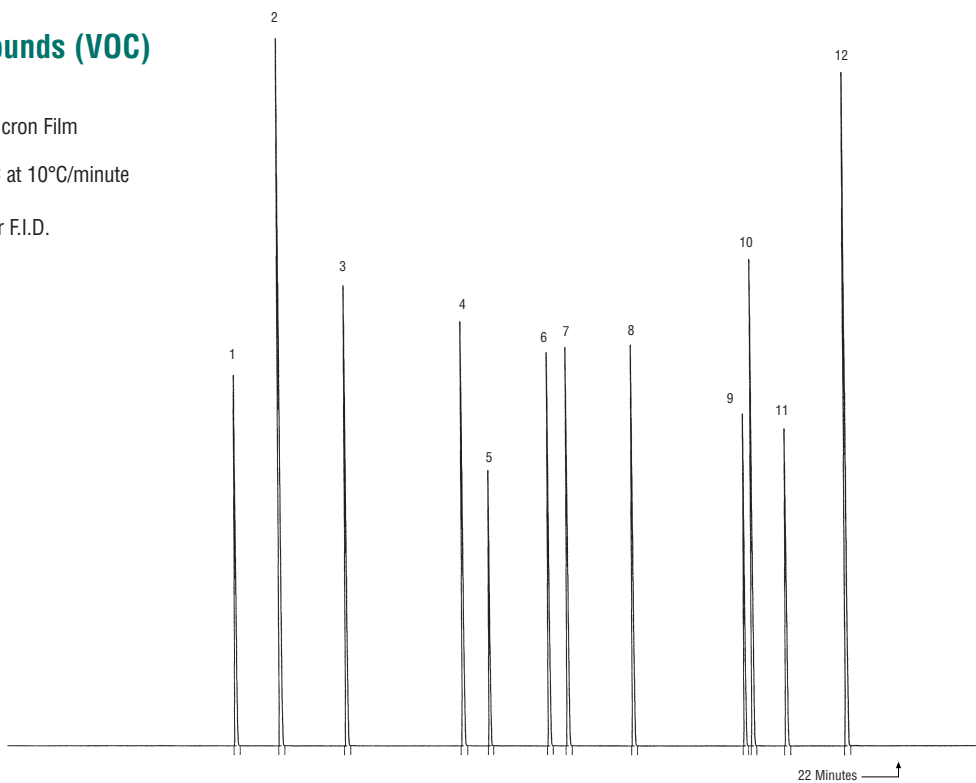

EPA Method 552.2

30 Meter x 0.32 mm OV[®]-5, 1.0 Micron Film, Catalog Number: 530-3204
 Oven: 50°C (Hold 5 minutes) > 225°C at 10°C/minute (Hold 20 minutes)
 (All Compounds Methylated)

1. Monochloroacetic acid (MCAA)
2. Monobromoacetic acid (MBAA)
3. Dichloroacetic acid (DCAA)
4. Dalapon
5. Bromochloroacetic acid (BCAA)
6. Trichloroacetic acid (TCAA)
7. Dibromoacetic acid (DBAA)
8. Bromodichloroacetic acid (BDCAA)
9. Chlorodibromoacetic acid (CDBAA)
10. Tribromoacetic acid (TBAA)

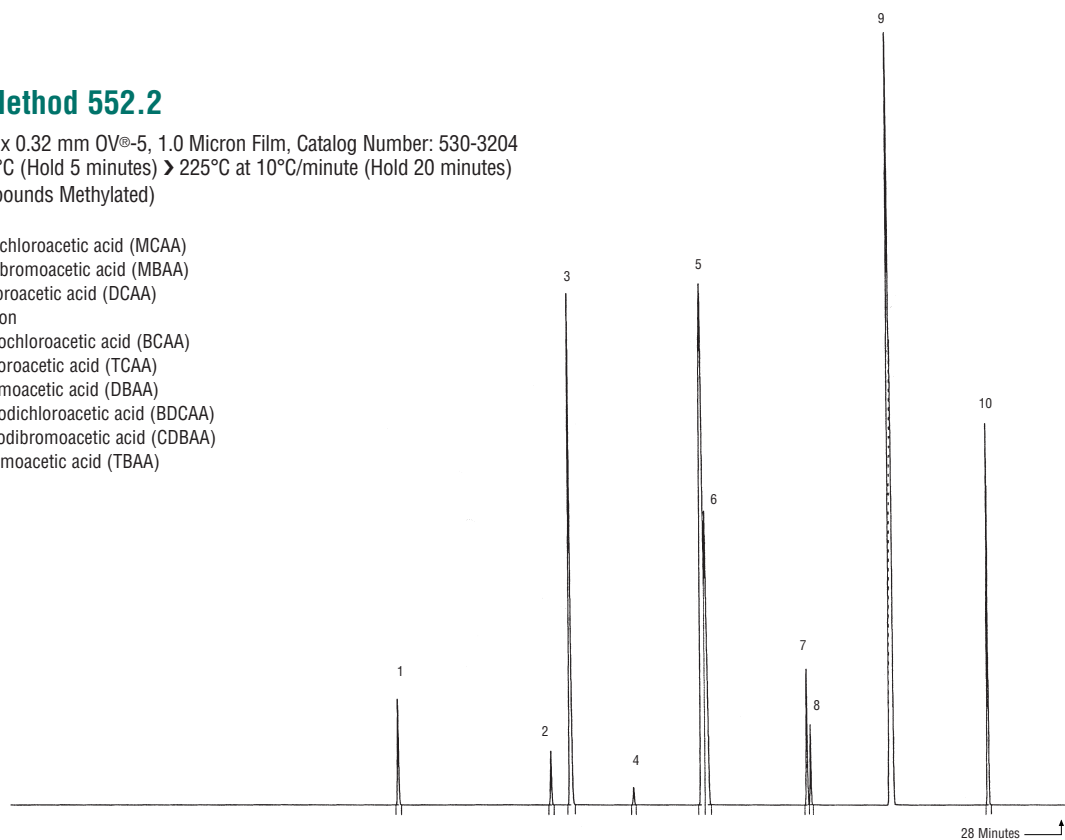

Hazardous Substance Mix

30 Meter x 0.25 mm OV[®]-1, 0.50 Micron Film, Catalog Number: 130-2503
 Oven: 50°C > 250°C at 8°C/minute (Hold 20 minutes)
 Injection Temperature 275°C
 Detector Temperature 300°C

1. Aniline
2. Benzyl Alcohol
3. 2-Methylphenol
4. 4-Methylphenol
5. 4-Chloroaniline
6. 2-Methylnaphthalene
7. 2,4,5-Trichlorophenol
8. 2-Nitroaniline
9. 3-Nitroaniline
10. Dibenzofuran
11. 4-Nitroaniline

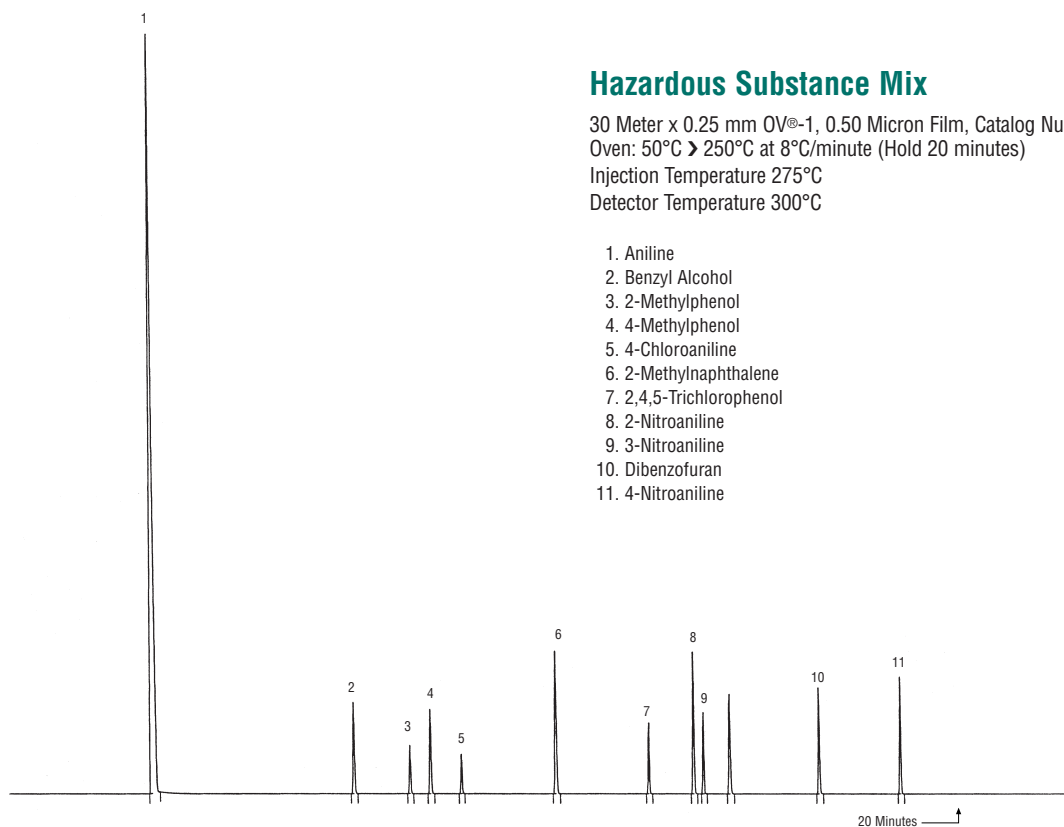

Residual Solvents

30 Meter x 0.32 mm OV®-5, 0.25 Micron Film, Catalog Number: 530-3202
 Oven: 30°C > 150°C at 10°C/minute
 Injection Temperature 250°C
 Detector Temperature 305°C

1. Ethanol
2. Acetonitrile
3. 1,1-Dichloroethane
4. Methylene chloride
5. Hexane
6. Chloroform
7. Carbon tetrachloride
8. Benzene
9. Trichloroethylene
10. 1,4-Dioxane
11. Pyridine

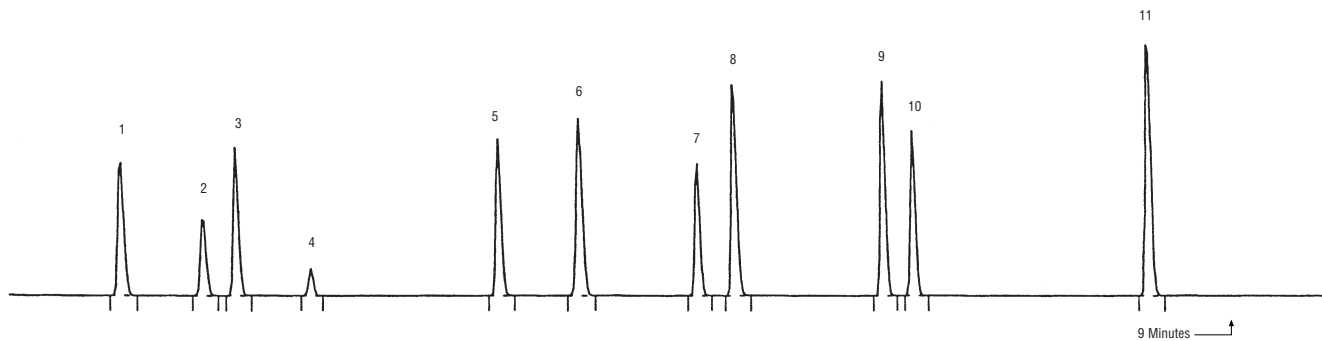

FAME

15 Meter x 0.32 mm Carbowax 20M, 0.25 Micron Film, Catalog Number: 215-3202
 Oven: 80°C > 200°C at 10°C/minute (Hold 10 minutes)

1. Caproic acid methyl ester (C6:0)
2. Caprylic acid methyl ester (C8:0)
3. Nonanoic acid (C9)
4. Capric acid methyl ester (C10:0)
5. Lauric acid methyl ester (C12:0)
6. Tridecanoic acid methyl ester (C13:0)
7. Myristic acid methyl ester (C14:0)
8. Palmitic acid methyl ester (C16:0)
9. Heptadecanoic acid methyl ester (C17:0)
10. Stearic acid methyl ester (C18:0)
11. Oleic acid methyl ester (C18:1n9c)
12. Linoleic acid methyl ester (C18:2n6c)
13. Linolenic acid methyl ester (C18:3n3)

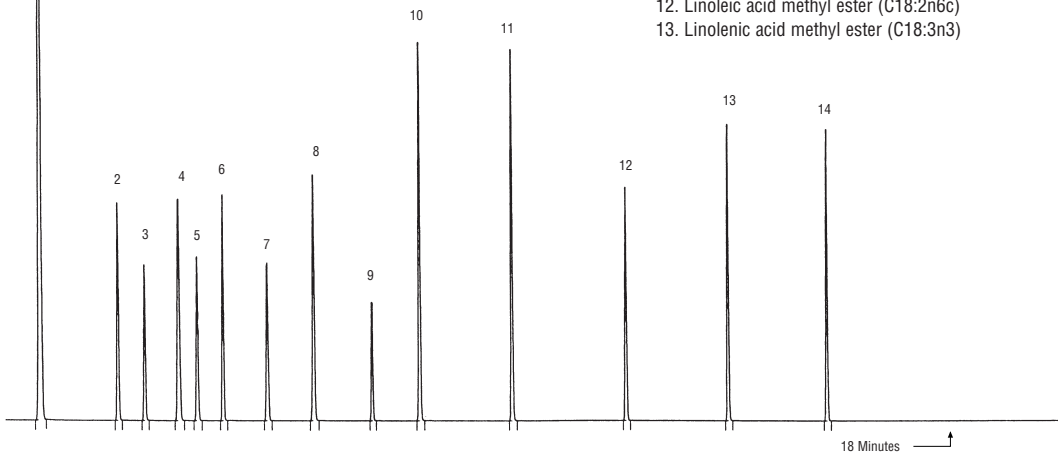

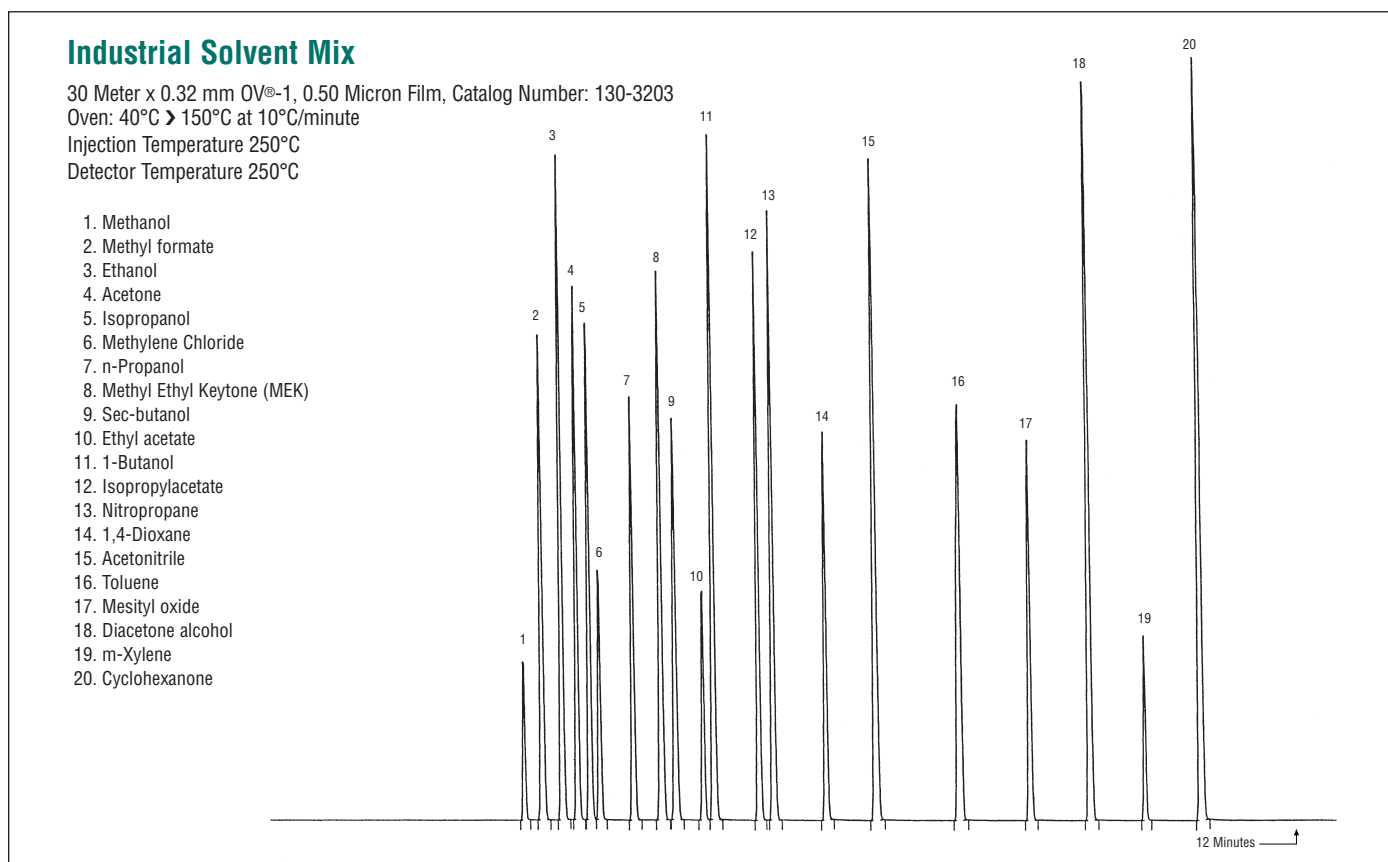
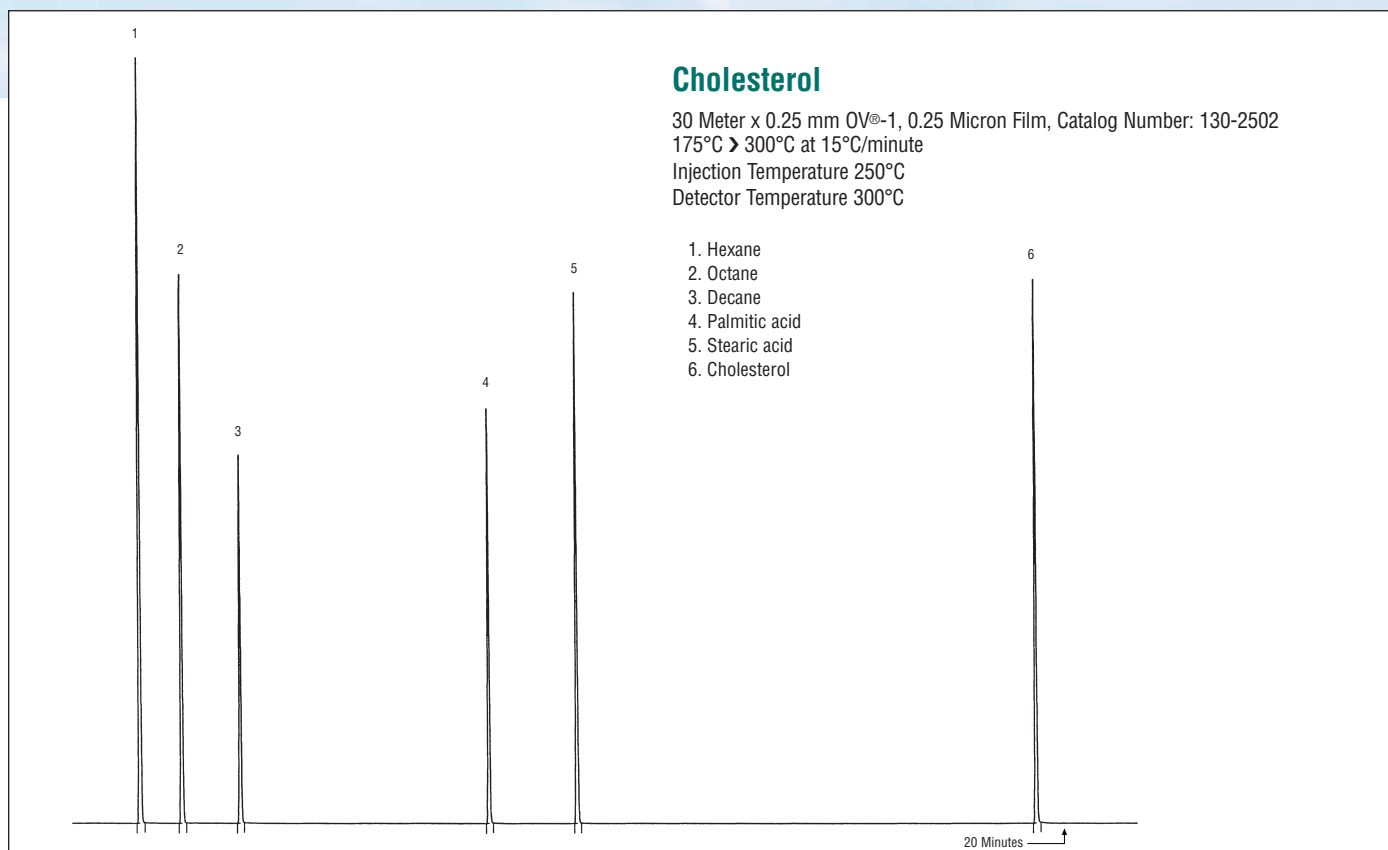

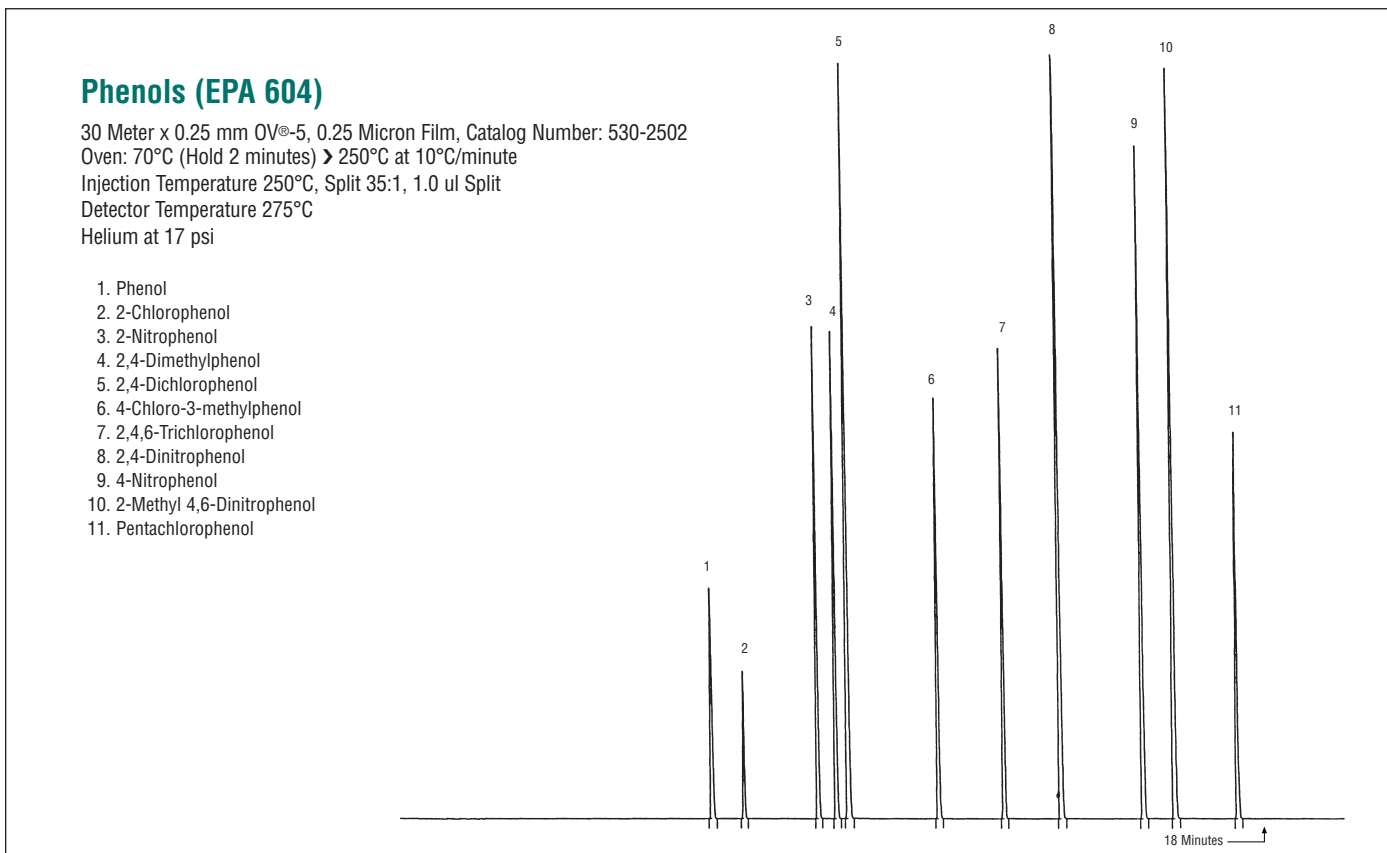
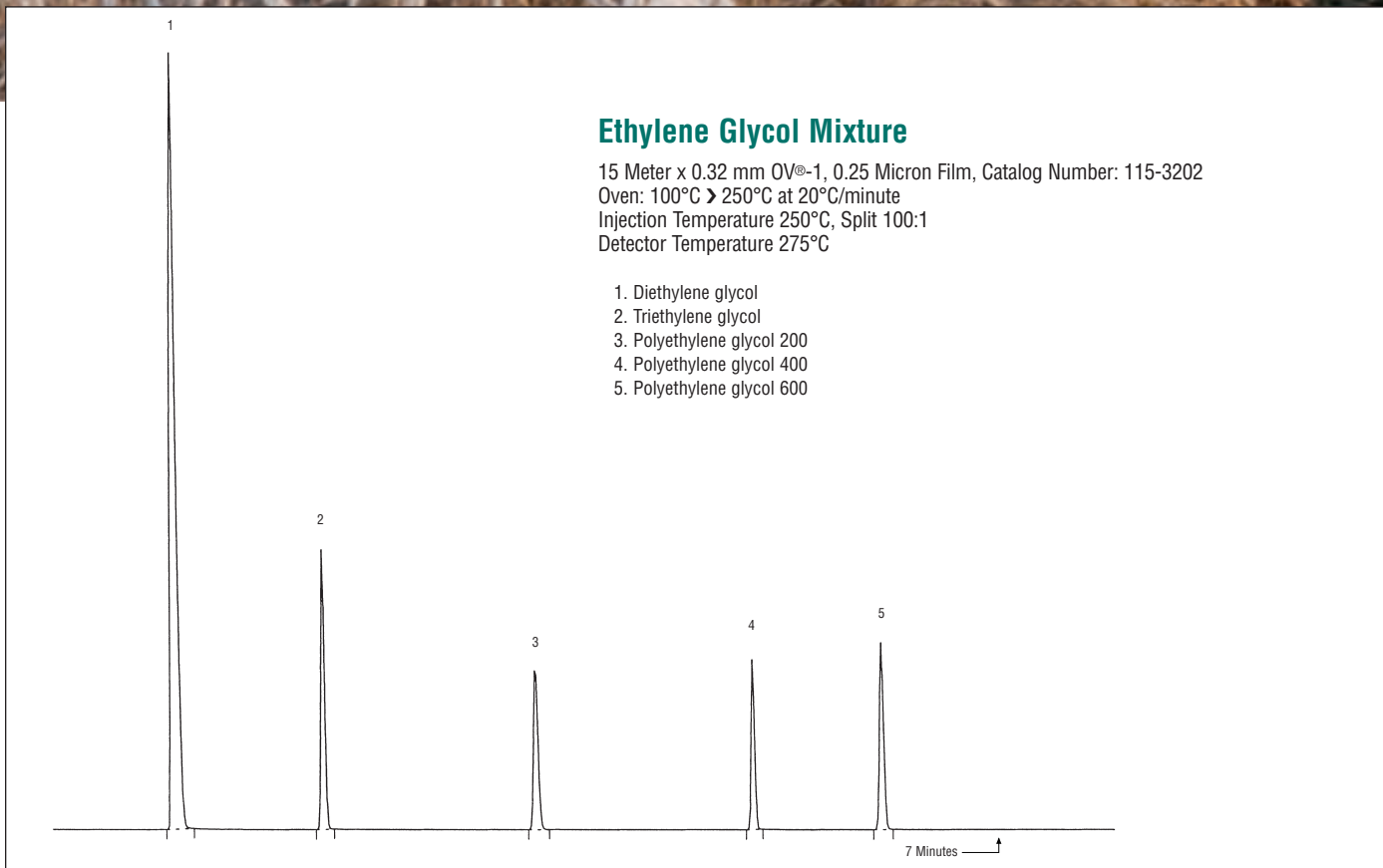

Nitroaromatics

15 Meter x 0.53 mm OV[®]-5, 1.0 Micron Film, Catalog Number: 515-5304

Oven: 125°C > 300°C at 15°C/minute

Injection Temperature 275°C

Detector Temperature 325°C

Helium at linear velocity of 20 cm/second

1. Nitrobenzene
2. Isophorone
3. 2,6-Dinitrotoluene
4. 2,4-Dinitrotoluene

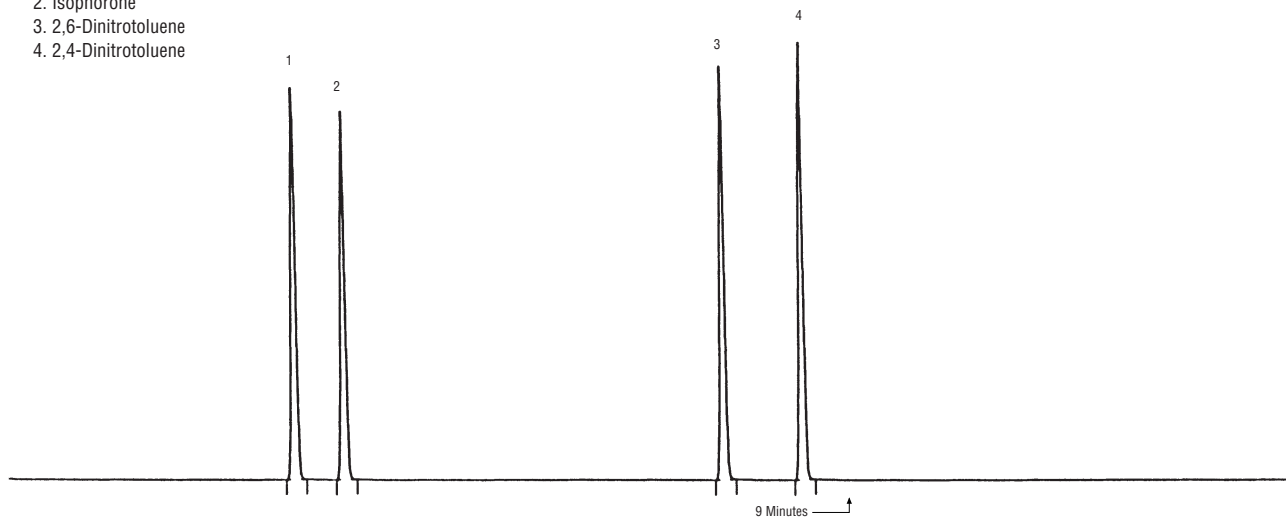

Headspace Analysis - USP 467 Solvents

30 Meters x 0.53 mm OV[®]-624, 3.0 Micron Film, Catalog Number: 630-5307

Headspace Temperature 150°C

Oven: 40°C (Hold 3 minutes) 260°C at 20°C/minute

Detector Temperature 300°C, Detector F.I.D.

1. Methylene Chloride
2. Chloroform
3. Benzene
4. Trichloroethylene
5. 1,4-Dioxane

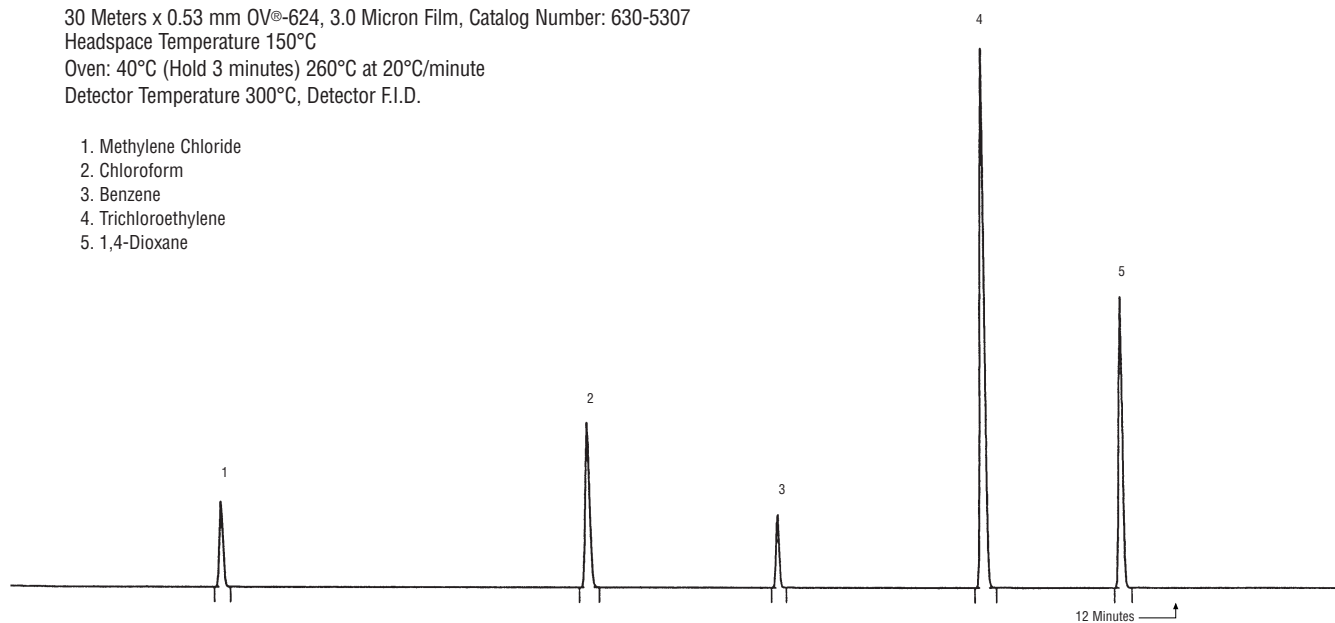

Headspace Analysis of Volatile Aromatics

30 Meters x 0.53 mm OV®-624, 3.0 Micron Film, Catalog Number: 630-5307
 Headspace Temperature 90°C
 Oven: 40°C (Hold 3 minutes) > 250°C at 30°C/minute (Hold 20 minutes)
 Detector Temperature 300°C, Detector F.I.D.

- 1. p-Xylene
- 2. Isopropyl benzene
- 3. o-Xylene
- 4. n-Propyl benzene
- 5. Chlorobenzene
- 6. Tert-butyl benzene
- 7. Sec-butyl benzene
- 8. 2-Chlorotoluene
- 9. 4-Chlorotoluene
- 10. 1,3-Dichlorobenzene
- 11. 1,4-Dichlorobenzene
- 12. 1,2-Dichlorobenzene

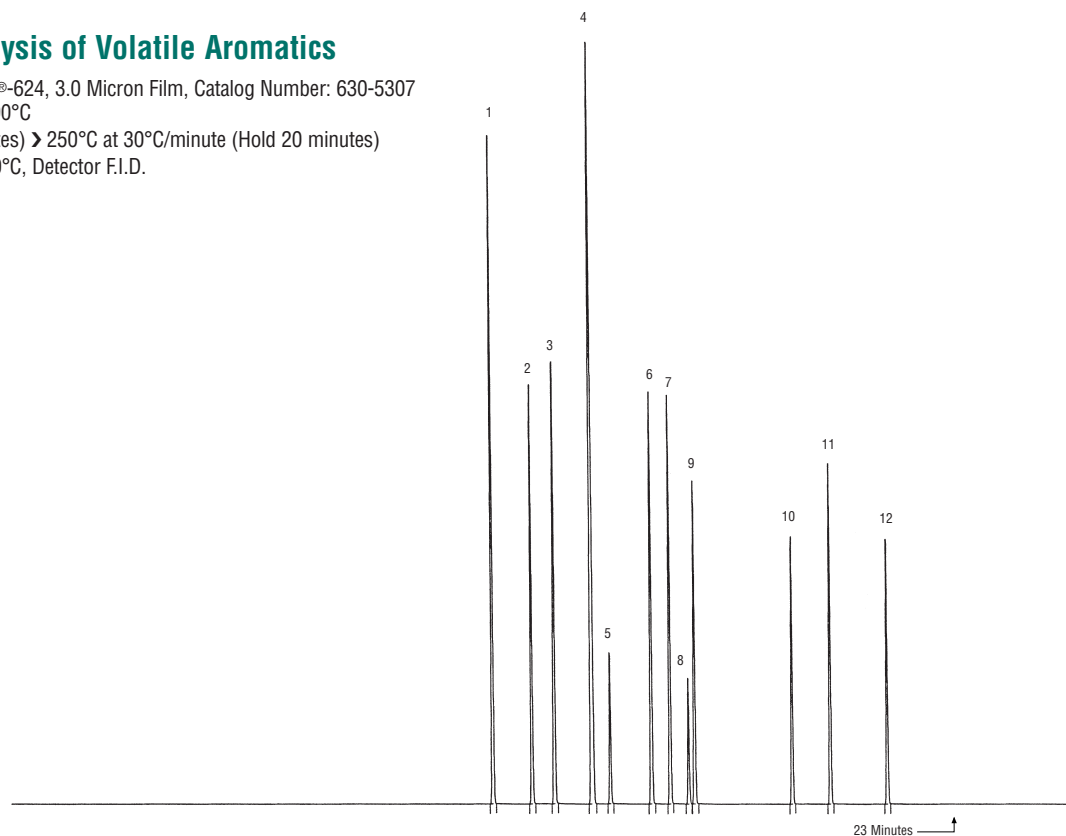

Endocrine Disruptors - Alkyl Phenol

30 Meter x 0.25 mm OV®-5, 0.25 Micron Film, Catalog Number: 530-2502
 Oven: 40°C > 300°C at 10°C/minute (Hold 15 minutes)

- 1. Tert-butyl phenol
- 2. n-Pentyl phenol
- 3. n-Hexyl phenol
- 4. n-Heptyl phenol
- 5. Tert-octyl phenol
- 6. n-Octyl phenol
- 7. n-nonyl
- 8. Bisphenol A

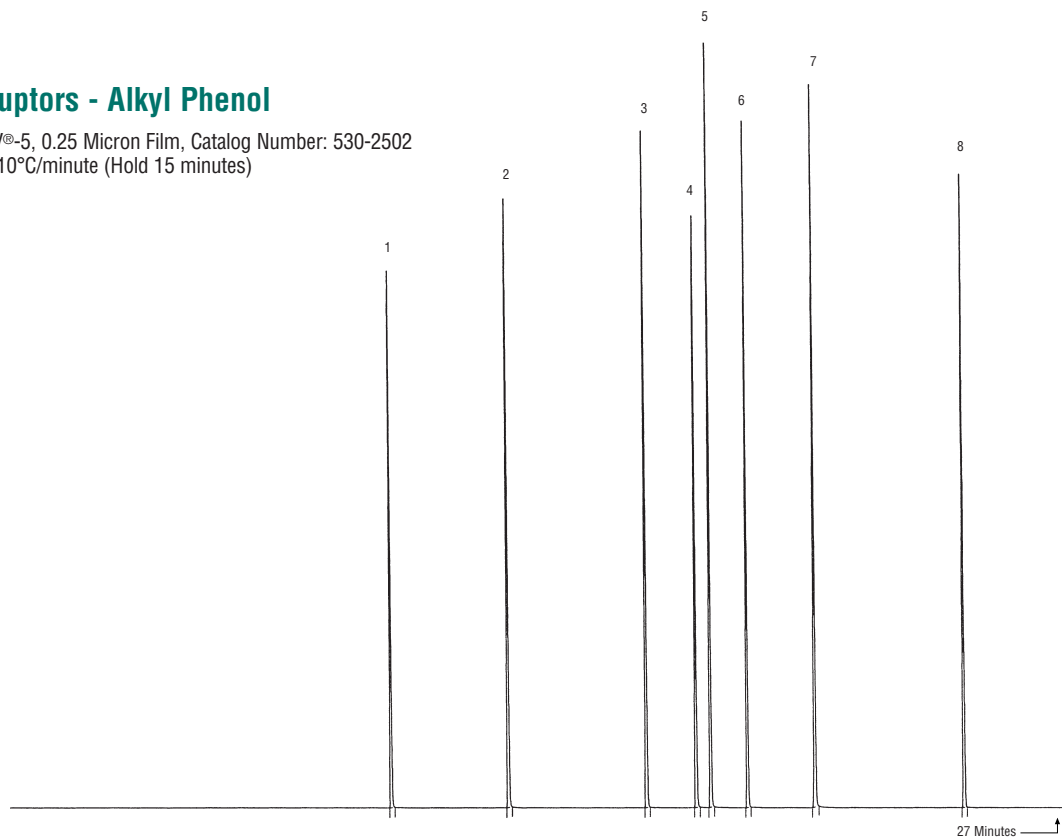

Component Index

- Acenaphthene 62
 Acenaphthylene 62
 Acetaminophen 70
 Acetone 58, 59, 67, 75
 Acetonitrile 69, 70, 74, 75
 Acrolein 69, 70
 Acrylamide 69
 Acrylonitrile 69, 70
 Aldrin 57, 60, 67
 Aniline 73
 Anthracene 62
 Arabinitol 71
 Arochlor 1016 56
 Arochlor 1021 56
 Arochlor 1254 56
 Aspirin 70
 BCAA 73
 BDCAA 73
 BHC 57, 60, 67
 Benzene 57, 58, 62, 65, 68, 72, 74, 77
 Benzo (a) Anthracene 62
 Benzo (a) Fluoranthene 62
 Benzo (a) Pyrene 62
 Benzo (ghi) Perylene 62
 Benzo (k) Fluoranthene 62
 Benzointrile 70
 Benzyl Alcohol 73
 Bis (2-Chloroethoxy) Methane 66
 Bis (2-Chloroethyl) Ether 66
 Bis (2-Chloroisopropyl) Ether 66
 Bis (2-Ethylhexyl) Phthalate 59
 Bis (2-Ethylhexyl) Phthalate 66
 Bis (2-n-Butoxyethyl) Phthalate 59
 Bis (4-Methyl-2-Pentyl) Phthalate 59
 Bis (Ethoxyethyl) Phthalate 59
 Bisphenol A 78
 Bromo-1-Chloropropane 63
 Bromobenzene 62, 64
 Bromochloroacetic Acid (BCAA) 73
 Bromochloromethane 62, 64
 Bromodichloroacetic Acid (BDCAA) 73
 Bromodichloromethane 60, 62, 63, 64
 Bromofluorobenzene 62, 64
 Bromoform 60, 62, 63, 64
 Bromomethane 62, 64
 Bromophenyl Phenyl Ether 66
 Butane 65, 68
 Butanol 58, 59, 68, 72, 75
 sec-Butanol 68, 75
 tert-Butanol 68
 Butanone 63
 Butanone (MEK) 68, 69
 cis-2-Butene 68
 Butylbenzene 58, 62, 64
 sec-Butylbenzene 58, 62, 64, 78
 tert-Butylbenzene 62, 64, 78
 Butyl Benzyl Phthalate 59, 66
 Butyl Cellosolve 67
 tert-Butylphenol 78
 C10 (n-Decane) 61, 65, 75
 C11 (n-Undecane) 65
 C12 (n-Dodecane) 65
 C13 (n-Tridecane) 61, 65
 C14 (n-Tetradecane) 65
 C6 (n-Hexane) 65, 68, 74, 75
 C8 (n-Octane) 65, 75
 CDBAA 73
 Caffeine 70
 Capric Acid methyl ester (C10:0) 74
 Caproic Acid methyl ester (C6:0) 74
 Caprylic Acid methyl ester (C8:0) 74
 Carbon Tetrachloride 62, 64, 68, 69, 72, 74
 Cellosolve Acetate 67
 Chlordane 57, 67
 Chloro m-Cresol 60
 Chloro-3-Methylphenol 64, 76
 Chloroaniline 73
 Chlorobenzene 57, 62, 63, 64, 68, 72, 78
 Chlorodibromoacetic Acid (CDBAA) 73
 Chloroethane 62, 64
 Chloroethyl Vinyl Ether 72
 Chloroform 60, 62, 63, 64, 68, 69, 74, 77
 Chloromethane 62, 64
 Chloronaphthalene 66
 Chlorophenol 60, 64, 76
 Chlorophenyl Phenyl Ether 66
 Chloropropane 63
 Chlorotoluene 62, 64, 78
 Cholesterol 75
 Chrysene 62
 Cyclo C-6 67
 Cyclohexanone 75
 Cymene 58
 DBAA 73
 DCAA 73
 DDD 57, 60, 67
 DDE 57, 60, 67
 DDT 57, 60, 67
 DMF 70
 DMSO 70
 Dalapon 73
 Decachlorobiphenyl 57
 Decane 61, 65
 Decanol 61, 72
 Demeton-O 71
 Demeton-S 71
 Di-Amyl Phthalate 59
 Di-Isobutyl Phthalate 59
 Di-Nodul Phthalate 59
 Di-Nonyl Phthalate 59
 Di-n-Butyl Phthalate 59, 66
 Di-n-Hexyl Phthalate 59
 Di-n-Octyl Phthalate 66
 Diacetone Alcohol 75
 Dibenzo (ah) Anthracene 62
 Dibenzofuran 73
 Dibromo 63
 Dibromo-3-Chloropropane 60, 62, 64
 Dibromoacetic Acid (DBAA) 73
 Dibromochloromethane 60, 62, 63, 64, 72
 Dibromoethane 62, 63, 64
 Dibromomethane 60, 62, 64
 Dibutyl Chlorendate 60
 Dichloroacetic Acid (DCAA) 73
 Dichlorobenzene 57, 62, 63, 64, 66, 78
 Dichlorobenzene-d4 62, 64
 Dichlorodifluoromethane 62, 64
 Dichloroethane 62, 63, 64, 68, 69, 72, 74
 Dichloroethene 62, 64, 68, 72
 cis-1, 2-Dichloroethene 62
 trans-1, 2-Dichloroethene 62, 64
 cis-2-Dichloroethene 64
 Dichloroethylene 69
 Dichlorophenol 60, 64, 76
 Dichloropropane 62, 64, 72
 Dichloropropene 62, 64
 cis-1, 3-Dichloropropene 62, 64
 trans-1, 3-Dichloropropene 62, 64
 Dicyclohexyl Phthalate 59
 Dieldrin 57, 60, 67
 Diethyl Ether 69
 Diethyl Phthalate 59
 Diethylene Glycol 76
 Dihydroequilin 59
 Diisopropyl Benzene 58
 Dimethyl Phthalate 59, 66
 Dimethylaniline 61
 Dimethylformamide (DMF) 70
 Dimethylphenol 60, 61, 64, 76
 Dimethylsulfoxide (DMSO) 70
 Dinitro o-cresol 60
 Dinitrophenol 60, 64, 76
 Dinitrotoluene 63, 77
 Dioxane 74, 75, 77
 Disulfoton 71
 Docosane 65
 Dodecane 65
 Eicosane 65
 Endosulfan I 60, 67
 Endosulfan II 60, 67
 Endosulfan Sulfate 60, 67
 Endosulphan I 60
 Endosulphan II 60
 Endosulphin I 57
 Endosulphin II 57
 Endosulphin Sulfate 57
 Endrin 57, 60, 67
 Endrin Aldehyde 60, 67
 Endrin Ketone 57, 67
 Equilin 59
 Estradiol 59
 Estrone 59
 Estrone Methyl Ether 59
 Ethane 65, 68
 Ethanol 58, 59, 67, 68, 69, 72, 74, 75
 Ethyl Acetate 58, 59, 67, 75
 Ethyl Acrylate 70
 Ethyl Parathion 71
 Ethylbenzene 57, 58, 62, 64, 67
 Ethylene 68
 Eucalyptol 63
 Fensulfothion 71
 Fenthion 71
 Fluoranthene 62
 Fluorene 62
 Fluorobenzene 62, 63, 64
 Fucitol 71
 Galactitol 71

- Glucitol 71
 Heptachlor 57, 60, 67
 Heptachlorepoide 57, 60, 67
 Heptadecanoic Acid methyl ester 74
 Heptane 65
 Heptanol 72
 Heptyl phenol 78
 Hexachlorobenzene 66
 Hexachlorobutadiene 62, 64, 66
 Hexachlorocyclohexane 60
 Hexachlorocyclopentadiene 66
 Hexachloroethane 66
 Hexacosane 65
 Hexadecane 65
 Hexane 65, 68, 74
 Hexanol 72
 Hexyl 2-Ethylhexyl Phthalate 59
 Hexyl Phenol 78
 Ibuprofen 70
 Indeno (123-cd) Pyrene 62
 Inositol 71
 Isobutane 68
 Isobutanol 67, 68
 Isobutene 68
 Isobutylbenzene 58
 Isophorone 63, 77
 Isopropanol 58, 59, 68, 75
 Isopropylacetate 75
 Isopropylbenzene 58, 62, 64, 78
 Isopropyltoluene 62, 64
 Lauric Acid methyl ester (C12:0) 74
 Lindane 60
 Linolenic Acid methyl ester (C18:3n3) 74
 MBAA 73
 MCAA 73
 MEK 67, 75
 MIBK 69
 Mannitol 71
 Menthol 63
 Merphos 71
 Mesityl Oxide 75
 Mesitylene 58
 Methacrolein 70
 Methacrylonitrile 70
 Methane 65, 68
 Methanol 58, 59, 66, 67, 68, 75
 Methoxychlor 57, 67
 Methyl 12-Methyltetradecanoate 59
 Methyl 14-Methylhexadecanoate 59
 Methyl 2-Hydroxydecanoate 59
 Methyl 2-Hydroxydodecanoate 59
 Methyl 2-Hydroxyhexadecanoate 59
 Methyl 2-Hydroxytetradecanoate 59
 Methyl 3-Hydroxydodecanoate 59
 Methyl 3-Hydroxytetradecanoate 59
 Methyl 4,6-Dinitrophenol 64, 76
 Methyl Arachidate 59
 Methyl Decanoate 61
 Methyl Ethyl Keytone (MEK) 67, 75
 Methyl Formate 75
 Methyl Heptadecanoate 59
 Methyl Isobutyl Ketone (MIBK) 69
 Methyl Laurate 59
 Methyl Myristate 59
 Methyl Nonadecanoate 59
 Methyl Oleate 59
 Methyl Palmitate 59
 Methyl Palmitoleate 59
 Methyl Parathion 71
 Methyl Pentadecanoate 59
 Methyl Salicylate 63
 Methyl Stearate 59
 Methyl Styrene 58
 Methyl Tridecanoate 59
 Methyl Undecanoate 59
 Methyl dl-cis-9, 10-methylene hexadecano 59
 Methyl dl-cis-9, 10-methylene octadecano 59
 Methyl tert-Butyl Ether 68
 Methyl-1-Butanol 58, 59
 Methyl-1-Propanol 58, 59
 Methyl-2-Pyrrolidinone 70
 Methylene Chloride 62, 63, 64, 68, 72, 74, 75, 77
 Methylisobutylketone 67
 Methylnaphthalene 73
 Methylphenol 73
 Mevinphos 71
 Monobromoacetic Acid (MBAA) 73
 Monochloroacetic Acid (MCAA) 73
 Monocrotophos 71
 Myristic Acid methyl ester (C14:0) 74
 Naphthalene 61, 62, 64
 Nicotine 70
 Nitroaniline 73
 Nitrobenzene 63, 77
 Nitrophenol 60, 64, 76
 Nitropropane 75
 Nonane 65
 Nonanoic Acid (C9) 74
 Nonanol 72
 Nonyl 78
 Octacosane 65
 Octadecane 65
 Octane 65
 Octanol 61, 72
 Octyl Phenol 78
 tert-Octyl Phenol 78
 Oleic Acid methyl ester (C18:1n9c) 74
 Orange Oil 61
 Palmitic Acid 75
 Palmitic Acid methyl ester (C16:0) 74
 Paraldehyde 69
 Pentachlorophenol 60, 64, 76
 Pentane 65, 68
 Pentanol 58, 59, 72
 Pentyl Phenol 78
 Peppermint Oil 61
 Phenanthrene 62
 Phenol 60, 64, 76
 Phorate 71
 Polyethylene Glycol 200 76
 Polyethylene Glycol 400 76
 Polyethylene Glycol 600 76
 Propadiene 68
 Propane 65, 68
 Propanol 58, 59, 68, 72, 75
 Propionitrile 70
 Propyl Benzene 58, 62, 64.78
 Propylene 68
 Propylene Glycol 63
 Pyrene 62
 Pyridine 68, 70, 74
 Rhamnitol 71
 Ribitol 71
 Spearmint Oil 61
 Stearic Acid 75
 Stearic Acid methyl ester (C18:0) 74
 Styrene 58, 62, 64
 TBAA 73
 TCAA 73
 Tetrachloroethane 62, 64
 Tetrachloroethene 62, 63, 64, 68, 72
 Tetrachloroethylene 69
 Tetrachlorometaxylene 57
 Tetracosane 65
 Tetradecane 65
 Toluene 57, 58, 62, 64, 67, 75
 Tribromoacetic Acid (TBAA) 73
 Trichloroacetic Acid (TCAA) 73
 Trichlorobenzene 62, 64, 66
 Trichloroethane 62, 64, 63, 69, 72
 Trichloroethene 62, 64, 68, 72
 Trichloroethylene 69, 74, 77
 Trichlorofluoromethane 62, 64
 Trichlorophenol 60, 64, 73, 76
 Trichloropropane 62, 64
 Tridecane 61
 Tridecanoic Acid methyl ester (C13:0) 74
 Triethylamine 70
 Triethylene Glycol 76
 Trimethylbenzene 62, 64
 Undecane 65
 Undecanol 72
 Vinyl Chloride 62, 63, 64
 Xylene 57, 58, 62, 64, 67, 75, 78

QUALITY

All items listed in this catalog are of the highest possible quality. Extreme care should be taken to ensure that the materials are not contaminated during use.

WARNING

All chemicals listed in this catalog are designed for laboratory use and are not to be used for food or drug purposes. Many of these chemicals have not undergone detailed testing for hazards and toxicology.

OVSC assumes the user to be competent and professional, and to take precautions appropriate for the use of chemicals of unknown hazard and toxicity. The burden of the safe use of all chemicals sold by OVSC rests with the customer. OVSC expressly disclaims any responsibility for the completeness or accuracy of any information supplied concerning the toxicity, hazards, or suitability for intended use of any chemicals sold by us.

CUSTOM SERVICE

We would welcome any opportunity to work with you on the custom preparation of any liquid phase or organosilicone material. Contact us by writing for further information on this custom service.

DOMESTIC SHIPMENTS

Unless otherwise specified, all shipments will be made by UPS or UPS-Blue. Parcel Post or Air Parcel Post will be used at your request. Common Carriers will be used for large shipments as required.

EXPORT SHIPMENTS

All non-restricted items will be shipped by UPS unless otherwise specified. Due to the extreme difficulty in shipping these materials, we reserve the right to refuse any order unless prior shipping arrangements have been made.

BULK QUANTITIES OR MULTIPLE UNITS

All of the materials listed in this catalog are available in larger quantities, usually at a lower price. Contact us for specific price quotations.

HOW TO ORDER

Because of the similarity in names between quite different chemicals, please use both the catalog number and chemical name when ordering. Please indicate also the quantity you desire and the catalog price. For the OV[®] liquid phases you need only list the OV[®]-number and the quantity desired.



THE HAMILTON CATALOG

Write us for the Hamilton Syringe Catalog. We can supply you with every item in the catalog — with excellent delivery

Ohio Valley Specialty Company trademarks used in this catalog:

ColorCoded.....Ohio Valley Specialty Company
Micro-Pak.....Ohio Valley Specialty Company
Snap-Lok.....Ohio Valley Specialty Company
Superspec.....Ohio Valley Specialty Company
OV.....Ohio Valley Specialty Company

The following trademarks have been used throughout this catalog:

Anakrom.....Analabs
Apiezon.....James G. Biddle Co.
Bentone.....National Lead Co.
Bytac.....Norton Plastics
Carbopack.....Supelco
Carbowax.....Union Carbide
Chromosorb.....Celite
Citroflex.....Pfizer Chemical
DC.....Dow Corning
Dexsil.....Dexsil Corp.
Dow.....Dow Chemical
Durapak.....Waters Association, Inc.
Epon.....Shell Chemical
Fluorolube.....Hooker Chem. Co.
Gas Chrom.....Applied Science Labs
Graphpac.....Alltech Assoc.
Hallcomid.....C.P. Hall
Hamilton.....Hamilton Co.
Hi-eff.....Applied Science Labs
Igepal.....G.A.F.
Microsep.....Canton Biomedical
Mininert.....Precision Sampling Corp.
Pennwalt.....Pennwalt Corp.
Poly-A-I-S.....Applied Science Labs
Porapak.....Waters Associates, Inc.
Porasil.....Waters Associates, Inc.
Reoplex.....Geigy Industries
Silar.....Silar Labs
Snoop.....Nupro Co.
Span.....I.C.I.
Supelcoport.....Supelco Inc.
Swagelok.....Crawford Fittings
PTFE.....E. I. DuPont
Tergitol.....Union Carbide
Triton.....Rohm and Haas
Ucon.....Union Carbide
Ultrabond.....Ultra Scientific
Versamid.....General Mills
Vespel.....E. I. DuPont
Viton.....E. I. DuPont

Distributed By



Ohio Valley Specialty
C O M P A N Y

115 Industry Road, Marietta, OH 45750
1-800-729-6872 • (740) 373- 2276 • Fax (740) 373-9910
E-mail: info@ovsc.com • Web: ovsc.com

©2013 Ohio Valley Specialty