



TRUST THE CONSUMABLES ENGINEERED FOR YOUR INSTRUMENTS

INTERACTIVE PDF

[▶ CLICK HERE TO VIEW THE TABLE OF CONTENTS](#)

2020 Atomic Spectroscopy Consumables and Supplies

AA | ICP-OES | ICP-MS | General Supplies | Reference Materials | Sample Preparation

PerkinElmer[®]
For the Better

What is Atomic Spectroscopy?

Atomic spectroscopy is the technique for determining the elemental composition of an analyte by its electromagnetic or mass spectrum. Several analytical techniques are available (Atomic Absorption [AA], Inductively Coupled Plasma Optical Emission Spectroscopy [ICP-OES], Inductively Coupled Plasma Mass Spectrometry [ICP-MS]), and selecting the most appropriate one is the key to achieving accurate, reliable, real-world results. Proper selection requires a basic understanding of each technique since each has its individual strengths and limitations. It also requires a clear understanding of your laboratory's analytical requirements.

1 H Hydrogen																	2 He Helium
3 Li Lithium	4 Be Beryllium											5 B Boron	6 C Carbon	7 N Nitrogen	8 O Oxygen	9 F Fluorine	10 Ne Neon
11 Na Sodium	12 Mg Magnesium											13 Al Aluminum	14 Si Silicon	15 P Phosphorus	16 S Sulfur	17 Cl Chlorine	18 Ar Argon
19 K Potassium	20 Ca Calcium	21 Sc Scandium	22 Ti Titanium	23 V Vanadium	24 Cr Chromium	25 Mn Manganese	26 Fe Iron	27 Co Cobalt	28 Ni Nickel	29 Cu Copper	30 Zn Zinc	31 Ga Gallium	32 Ge Germanium	33 As Arsenic	34 Se Selenium	35 Br Bromine	36 Kr Krypton
37 Rb Rubidium	38 Sr Strontium	39 Y Yttrium	40 Zr Zirconium	41 Nb Niobium	42 Mo Molybdenum	43 Tc Technetium	44 Ru Ruthenium	45 Rh Rhodium	46 Pd Palladium	47 Ag Silver	48 Cd Cadmium	49 In Indium	50 Sn Tin	51 Sb Antimony	52 Te Tellurium	53 I Iodine	54 Xe Xenon
55 Cs Caesium	56 Ba Barium	57-71 +	72 Hf Hafnium	73 Ta Tantalum	74 W Tungsten	75 Re Rhenium	76 Os Osmium	77 Ir Iridium	78 Pt Platinum	79 Au Gold	80 Hg Mercury	81 Tl Thallium	82 Pb Lead	83 Bi Bismuth	84 Po Polonium	85 At Astatine	86 Rn Radon
87 Fr Francium	88 Ra Radium	89-103 +	104 Rf Rutherfordium	105 Db Dubnium	106 Sg Seaborgium	107 Bh Bohrium	108 Hs Hassium	109 Mt Meitnerium	110 Ds Darmstadtium	111 Rg Roentgenium	112 Cn Copernicium	113 Nh Nihonium	114 Fl Flerovium	115 Mc Moscovium	116 Lv Livermorium	117 Ts Tennessine	118 Og Oganesson
119 Uue Ununennium	120 Ubn Unbibium	121-126 +															

+	57 La Lanthanum	58 Ce Cerium	59 Pr Praseodymium	60 Nd Neodymium	61 Pm Promethium	62 Sm Samarium	63 Eu Europium	64 Gd Gadolinium	65 Tb Terbium	66 Dy Dysprosium	67 Ho Holmium	68 Er Erbium	69 Tm Thulium	70 Yb Ytterbium	71 Lu Lutetium
+	89 Ac Actinium	90 Th Thorium	91 Pa Protactinium	92 U Uranium	93 Np Neptunium	94 Pu Plutonium	95 Am Americium	96 Cm Curium	97 Bk Berkelium	98 Cf Californium	99 Es Einsteinium	100 Fm Fermium	101 Md Mendelevium	102 No Nobelium	103 Lr Lawrencium
+	121 Ubu Unbibium	122 Ubb Unbibium	123 Ubt Unbitrium	124 Ubq Unbiguadium	125 Ubp Unbigpentium	126 Ubh Unbihexium									

New Investments – Local Support – Proven Quality!

For over 80 years, PerkinElmer has helped our global laboratory partners meet their most demanding application measurement challenges. Our experience in Chromatography, Spectroscopy and Materials Characterization gives us a unique advantage in providing holistic and comprehensive solutions for laboratories in universities and key market segments like Environmental, Energy and Food and Product Safety.

When you order our precision designed, genuine PerkinElmer consumables and accessories, you can enjoy the peace of mind, ease of ordering and best in class service. You'll get the results you need – accurately and on time. PerkinElmer selects only the highest quality products for our consumables portfolio and invests heavily to test and validate the quality of our products.

AMERICAS			
Country	Telephone	Facsimile	Email
ARGENTINA	54 11 4554 4004	54 11 4554 2807	
BOLIVIA	(591 2) 241 5446	(591 2) 241 0639	beco@entelnet.bo
BRAZIL	55 11 3868 6200	55 11 3868 6210	consumiveis.vendas@perkinelmer.com
CANADA	800 561 4646	905 851 1814	Orders.LSCanada@perkinelmer.com
CHILE	56 2 784 7500	56 2 236 6821	
COLUMBIA	(574) 230 57 67	(574) 230 56 04	
COSTA RICA	(506) 2 272 4700	(506) 2 272 9700	
DOMINICAN REPUBLIC	(809) 508 6500	(809) 532 0741	
ECUADOR	(593) 222 63 537	(593) 224 56 556	
EL SALVADOR	(503)2535 0700	(503)2535 0777	
GUATEMALA	(502) 25 02 47 00	(502) 25 02 47 01	
HONDURAS	(504) 2262 6700	(504) 2262 4000	
MEXICO	52 55 5337 0700	52 55 559 36223	CC.Mexico@perkinelmer.com
NICARAGUA	(505) 2 278 0177	(505) 278 0279	
PANAMA	507 3941 695	52 55 559 36223	
PARAGUAY	(598) 291 69857	(598) 291 69857	info@aldenor.com.uy
PERU	(511) 201 5800	(511) 444 9937	
PUERTO RICO	787 783 3067	787 793 7198	
TRINIDAD	(868) 671 1525	(868) 665 3703	
UNITED STATES	800 762 4000	203 944 4904	CustomerCareUS@perkinelmer.com
URUGUAY	(598) 291 69857	(598) 291 69857	info@aldenor.com.uy
VENEZUELA	58 212 7614757	58 212 7623050	

ORDERING INFORMATION

EUROPE			
Country	Telephone	Facsimile	Email
ALBANIA	0800 111 933	0800 111 934	cc.export@perkinelmer.com
AUSTRIA	0800 111 933	0800 111 934	cc.austria@perkinelmer.com
BELARUS	+7 495 935 8888	+7 495 564 8787	info@scheltec.ru
BELGIUM	0800 40858	0800 40859	cc.benelux@perkinelmer.com
BOSNIA HERZEGOVINA	+385 1 2001 767	+385 1 2001 724	hebe@hebe.hr
BULGARIA	+359 2 952 0301	+359 2 952 3784	chroma@spnet.net
CROATIA	+385 1 2001 767	+385 1 2001 724	hebe@hebe.hr
CYPRUS	+357 22 33 82 34	+357 22 33 82 32	sales@kriticos.com.cy
CZECH REPUBLIC	+420 241 430 534	+420 241 430 535	info@pesystems.cz
DENMARK	8088 4236	8088 4237	cc.nordic@perkinelmer.com
ESTONIA	+372 7 383 330	+372 7 383 360	kent@lanlab.ee
FINLAND	0800 117 186	0800 117 185	cc.nordic@perkinelmer.com
FRANCE	0805 111 333	0805 111 334	cc.france@perkinelmer.com
GERMANY	0800 181 0032	0800 181 0031	cc.germany@perkinelmer.com
GREECE	+30 2310 322525	+30 2310 321912	antisel@antisel.gr
HUNGARY	+36 1 251 1116	+36 1 251 1461	perform@per-form.hu
ICELAND	+354 412 7000	+354 412 7099	medor@medor.is
IRELAND	1800 932 886	1800 932 884	cc.ie@perkinelmer.com
ISRAEL	1700 500 512	1700 555 915	cc.israel@perkinelmer.com
ITALY	+39 800 906 642	+39 02 3601 2508	cc.italy@perkinelmer.com
LATVIA	+371 6755 1894	+371 6755 1976	info@adrone.lv
LITHUANIA	+370 5 2638748	+370 5 2638749	info@linealibera.it
LUXEMBOURG	0800 26588	0800 26589	cc.benelux@perkinelmer.com
MACEDONIA	+381 11 22 22 244	+381 11 22 22 244	perkinelmer@superlab.rs
MALTA	+39 081 7013094	+39 081 7021977	info@areachem.it
MOLDAVIA	+40 21 316 2877	+40 21 316 2876	office@chromatec.ro
MONTENEGRO	+381 11 22 22 244	+381 11 22 22 244	perkinelmer@superlab.rs
NETHERLANDS	0800 0234490	0800 0234491	cc.benelux@perkinelmer.com
NORWAY	800 18 854	800 18 855	cc.nordic@perkinelmer.com
POLAND	0800 88 08 88	+48 22 310 88 01	cc.pl@perkinelmer.com
PORTUGAL	+351 21 782 60 30	+351 21 782 60 39	ilc@ilc.pt
ROMANIA	+40 21 316 2877	+40 21 316 2876	office@chromatec.ro

EUROPE

Country	Telephone	Facsimile	Email
RUSSIAN FEDERATION	+7 495 935 8888	+7 495 564 8787	info@scheltec.ru
SERBIA	+381 11 22 22 244	+381 11 22 22 244	perkinelmer@superlab.rs
SLOVAKIA	+421 918 506782	+421 48 2301628	mLa@mediclabor.sk
SLOVENIA	+386 1 427 3213/3650	+386 1 427 3191	omega@omega.si
SPAIN	800 099 164	800 099 165	atencionalcliente@perkinelmer.com
SWEDEN	0200 887 520	0200 887 521	cc.nordic@perkinelmer.com
SWITZERLAND	0800 000 015	0800 000 016	cc.switzerland@perkinelmer.com
TURKEY	+90 212 312 1100	+90 212 312 1111	cc.turkey@perkinelmer.com
UKRAINE	+7 495 935 8888	+7 495 564 8787	info@scheltec.ru
UNITED KINGDOM	0800 89 60 46	0800 89 17 14	cc.uk@perkinelmer.com

ASIA

Country	Telephone	Facsimile	Email
AFGANISTAN	+92 21 5345581	+92 21 5345582	sales@amspvtltd.com
ARMENIA	+7 495 935 8888	+7 495 564 8787	info@scheltec.ru
AUSTRALIA	61 3 9212 8500 or 1 800 033 391	61 3 9212 8595	http://go.perkinelmer.com/Consumables
AZERBAIJAN	+90 212 212 5566	+90 212 212 2829	istanbul@tetratek.com.tr
CHINA	86 8008205046	86 2160645666	consumable.china@perkinelmer.com
GEORGIA	+7 495 935 8888	+7 495 564 8787	info@scheltec.ru
HONG KONG	852 2793 3218	852 2793 3225	info@aldenor.com.uy
INDIA	+91 22 33261700	+91 22 33261790	marketing.india@perkinelmer.com
INDONESIA	62 21 5694 5040 to 43	62 21 5694 5024	
JAPAN Kyushu	81 92 473 7001	81 92 473 8353	scalar@tstt.ent.tt
JAPAN Osaka	81 6 6386 6004	81 6 6386 7009	
JAPAN Tokyo	81 3 3866 2647	81 3 3866 2652	info@aldenor.com.uy
JAPAN Yokahama	81 45 339 5861	81 45 339 5871	
KAZAKHSTAN	+7 495 935 8888	+7 495 564 8787	info@scheltec.ru
KOREA	82 2 868 5376	82 2 868 4343	http://go.perkinelmer.com/Consumables
KYRGYZSTAN	+7 495 935 8888	+7 495 564 8787	info@scheltec.ru
MALAYSIA	603 7949 1118	603 7949 1119	http://go.perkinelmer.com/Consumables
MONGOLIA	+7 495 935 8888	+7 495 564 8787	info@scheltec.ru
NEW ZEALAND	64 21 215 1198 or 0800 724 663	64 3 384 1222	http://go.perkinelmer.com/Consumables

ORDERING INFORMATION

ASIA			
Country	Telephone	Facsimile	Email
PAKISTAN	+92 21 5345581	+92 21 5345582	sales@amspvtltd.com
PHILIPPINES	632 822 0511 to 16	632 822 0517	http://go.perkinelmer.com/Consumables
RUSSIAN FEDERATION	+7 495 935 8888	+7 495 564 8787	info@scheltec.ru
SINGAPORE	65 6868 1650	65 6872 6595	http://go.perkinelmer.com/Consumables
TAIWAN Taipei	886 2 87912589	886 2 87919085	http://go.perkinelmer.com/Consumables
TAIWAN Kaohsiung	886 7 5521030	886 7 5543402	http://go.perkinelmer.com/Consumables
TAJIKISTAN	+7 495 935 8888	+7 495 564 8787	info@scheltec.ru
THAILAND	662 319 7901	662 319 7900	http://go.perkinelmer.com/Consumables
TURKEY	+90 212 312 1100	+90 212 312 1111	cc.turkey@perkinelmer.com
TURKMENISTAN	+7 495 935 8888	+7 495 564 8787	info@scheltec.ru
VIETNAM Hanoi	84 4 3747 2258	84 4 3747 2260	http://go.perkinelmer.com/Consumables
VIETNAM Ho Chi Minh City	84 8 5431 8877	84 8 5431 8570	http://go.perkinelmer.com/Consumables
UZBEKISTAN	+7 495 935 8888	+7 495 564 8787	info@scheltec.ru

MIDDLE EAST AND GULF			
Country	Telephone	Facsimile	Email
BAHRAIN	+973 17276176	+973 17275819	info@ymh.com.bh
GAZA STRIP	+202 22905306	+202 22905307	info@htds.fr
IRAQ	+202 22905306	+202 22905307	info@htds.fr
ISRAEL	1700 500512	1700 555 915	cc.israel@perkinelmer.com
JORDAN	+962(0)6 534 6523	+962(0)6 534 6527	info@htds.fr
KUWAIT	+965 22419797	+965 22419798	las@emphor.biz
LEBANON	+202 22905306	+202 22905307	info@htds.fr
OMAN	+968 248 14752	+968 248 13924	big@bigllcoman.com
PALESTINIAN TERRITORIES	+202 22905306	+202 22905307	info@htds.fr
QATAR	+974 4654563	+974 4652256	las@emphor.biz
SAUDI ARABIA	+966 11477 7932	+966 11477 1314	info@aralgosaibico.com
UNITED ARAB EMIRATES	+971 4 883 0233	+971 4 883 0133	las@emphor.biz
WEST BANK	+202 22905306	+202 22905307	info@htds.fr
YEMEN	+967 234 5073	+967 234 0504	direct@alfalahye.net

AFRICA			
Country	Telephone	Facsimile	Email
ALGERIA	+213 (0)21 91 63 73	+213 (0)21 91 63 82	info@htds.fr
ANGOLA	+27 11 564 2400	+27 11 564 2440	info.za@perkinelmer.com
BENIN	+33 1 64 86 28 28	+33 1 69 07 69 54	info@htds.fr
BOTSWANA	+27 11 564 2400	+27 11 564 2440	info.za@perkinelmer.com
BRITISH INDIAN OCEAN	+202 22905306	+202 22905307	info@htds.fr
BURKINA FASO	+33 1 64 86 28 28	+33 1 69 07 69 54	info@htds.fr
BURUNDI	+33 1 64 86 28 28	+33 1 69 07 69 54	info@htds.fr
CAMEROON	+33 1 64 86 28 28	+33 1 69 07 69 54	info@htds.fr
CAPE VERDE	+33 1 64 86 28 28	+33 1 69 07 69 54	info@htds.fr
CENTRAL AFRICA REP.	+33 1 64 86 28 28	+33 1 69 07 69 54	info@htds.fr
CHAD	+33 1 64 86 28 28	+33 1 69 07 69 54	info@htds.fr
COMOROS	+33 1 64 86 28 28	+33 1 69 07 69 54	info@htds.fr
CONGO	+33 1 64 86 28 28	+33 1 69 07 69 54	info@htds.fr
DEMO. REP. CONGO	+33 1 64 86 28 28	+33 1 69 07 69 54	info@htds.fr
DSCHIBUTI REP.	+33 1 64 86 28 28	+33 1 69 07 69 54	info@htds.fr
EGYPT	+202 22905306	+202 22905307	info@htds.fr
EQUATORIAL GUINEA	+33 1 64 86 28 28	+33 1 69 07 69 54	info@htds.fr
ERITREA	+202 22905306	+202 22905307	info@htds.fr
ETHIOPIA	+202 22905306	+202 22905307	info@htds.fr
GABON	+33 1 64 86 28 28	+33 1 69 07 69 54	info@htds.fr
GAMBIA	+33 1 64 86 28 28	+33 1 69 07 69 54	info@htds.fr
GHANA	+202 22905306	+202 22905307	info@htds.fr
GUINEA	+33 1 64 86 28 28	+33 1 69 07 69 54	info@htds.fr
GUINEA – Bissau	+33 1 64 86 28 28	+33 1 69 07 69 54	info@htds.fr
IVORY COAST	+33 1 64 86 28 28	+33 1 69 07 69 54	info@htds.fr
KENYA	+202 22905306	+202 22905307	info@htds.fr
LESOTHO	+27 11 564 2400	+27 11 564 2440	info.za@perkinelmer.com
LIBERIA	+202 22905306	+202 22905307	info@htds.fr
LIBYA	+218/92 304 48 74	+218/21 713 21 12	info@htds.fr
MADAGASCAR	+33 1 64 86 28 28	+33 1 69 07 69 54	info@htds.fr

ORDERING INFORMATION

AFRICA			
Country	Telephone	Facsimile	Email
MALAWI	+27 11 564 2400	+27 11 564 2440	info.za@perkinelmer.com
MALI	+33 1 64 86 28 28	+33 1 69 07 69 54	info@htds.fr
MAURITANIA	+33 1 64 86 28 28	+33 1 69 07 69 54	info@htds.fr
MAURITIUS	+27 11 564 2400	+27 11 564 2440	info.za@perkinelmer.com
MOROCCO	+212/(0)522 27 49 59	+212/(0)522 20 83 74	info@htds.fr
MOZAMBIQUE	+27 11 564 2400	+27 11 564 2440	info.za@perkinelmer.com
NAMIBIA	+27 11 564 2400	+27 11 564 2440	info.za@perkinelmer.com
NIGER	+33 1 64 86 28 28	+33 1 69 07 69 54	info@htds.fr
NIGERIA	+202 22905306	+202 22905307	info@htds.fr
REUNION ISLANDS	+33 1 64 86 28 28	+33 1 69 07 69 54	info@htds.fr
RWANDA	+33 1 64 86 28 28	+33 1 69 07 69 54	info@htds.fr
SENEGAL	+33 1 64 86 28 28	+33 1 69 07 69 54	info@htds.fr
SEYCHELLES	+33 1 64 86 28 28	+33 1 69 07 69 54	info@htds.fr
SIERRA LEONE	+202 22905306	+202 22905307	info@htds.fr
SOMALIA	+202 22905306	+202 22905307	info@htds.fr
REPUBLIC OF SOUTH AFRICA	+27 11 564 0600	+27 11 564 0899	info.za@perkinelmer.com
SWAZILAND	+27 11 564 2400	+27 11 564 2440	info.za@perkinelmer.com
TANZANIA	+202 22905306	+202 22905307	info@htds.fr
TOGO	+33 1 64 86 28 28	+33 1 69 07 69 54	info@htds.fr
TUNISIA	+216 70 836 961	+216 70 836 561	info@htds.fr
UGANDA	+202 22905306	+202 22905307	info@htds.fr
WESTERN SAHARA	+33 1 64 86 28 28	+33 1 69 07 69 54	info@htds.fr
ZAMBIA	+27 11 564 2400	+27 11 564 2440	info.za@perkinelmer.com
ZIMBABWE	+27 11 564 2400	+27 11 564 2440	info.za@perkinelmer.com

Atomic Spectroscopy

PerkinElmer is the world leader in atomic spectroscopy solutions for atomic absorption (AA), inductively coupled plasma optical emission spectroscopy (ICP-OES) and inductively coupled plasma mass spectrometry (ICP-MS). With instruments that are the industry standard worldwide, PerkinElmer accessories, consumables, methods and application support meet the most demanding requirements and are the preferred choice in thousands of laboratories globally.

We invest heavily in testing and validating our complete portfolio of solutions to ensure that you receive accurate, repeatable results, on-time, every time throughout the lifetime of your instrument. From Lumina hollow cathode lamps that allow automatic setup and provide long lamp lifetime to our PerkinElmer Pure Standards that have been analyzed and certified to yield reliable, accurate results, you'll be able to relax knowing you have the best. We also offer a complete portfolio of specialized consumables that deliver reliable performance, control operating costs and maximize the uptime of your instrument.

When you order our precision-designed, genuine Atomic Spectroscopy PerkinElmer consumables and supplies, you'll get the results you need – accurately and on time.

Ordering Information

Place your order online at: www.perkinelmer.com/shop

Online ordering is currently available in Australia, Austria, Belgium, Canada, China, Denmark, Finland, France, Germany, Ireland, Italy, Luxemburg, the Netherlands, Norway, Puerto Rico, Singapore, Spain, Sweden, Switzerland, the United Kingdom and the United States.

Please contact your local PerkinElmer Customer Care Representative. Or visit www.perkinelmer.com/lasoffices.

Visit us online at www.perkinelmer.com/lasoffices to obtain the correct address for mailing your company Purchase Order.

Return Goods Policy

Before returning any item to PerkinElmer, please obtain a Return Authorization Number from a customer service representative. Call your local PerkinElmer office and please have the following information ready:

- Our Order Number or your Purchase Order Number
- The PerkinElmer part numbers of the items that you wish to return
- Reason for return

Our customer service representative will provide you with a Return Authorization Number and the return address. We cannot accept any returns without a Return Authorization Number. Policy may vary. Please contact your local PerkinElmer representative for details.

Technical Support

For technical assistance, please contact your local PerkinElmer Customer Care Representative. See local office listings.

Check with your local PerkinElmer Customer Care center for current pricing.

PerkinElmer and the PerkinElmer logo are registered trademarks of PerkinElmer, Inc. All other product and company names mentioned herein may be the trademarks or registered trademarks of their respective owners.

PerkinElmer is not responsible for typographical or photographic errors that may appear in this catalog. We reserve the right to make adjustments or corrections due to changing market conditions, product discontinuations, or typographical or photographic errors in advertisements or product descriptions. Terms and conditions and item availability are subject to change without notice.

Terms and Conditions

For details on our terms and conditions, including warranties, please visit: www.perkinelmer.com/terms

Table of Contents

>	ATOMIC ABSORPTION	12-39
>	INDUCTIVELY COUPLED PLASMA-OES	40-65
>	INDUCTIVELY COUPLED PLASMA-MS	66-87
>	ATOMIC SPECTROSCOPY GENERAL SUPPLIES	88-107
>	REFERENCE MATERIALS	108-129
>	SAMPLE PREPARATION	130-137
>	SERVICE CONTRACTS AND TRAINING	138-139
>	PART NUMBER INDEX	140-155
>	ALPHABETICAL INDEX	156-161

The Most Trusted Name in Elemental Analysis

From AA to ICP-OES and ICP-MS, we've been at the forefront of elemental analysis for more than 50 years.

Join forces with us and give your laboratory the benefits of cutting-edge instrumentation, consistently excellent consumables and the industry's largest, most trusted service and applications support network.



PinAAcle 500 Flame AA

The PinAAcle™ 500 offers superior durability, longer life, lower maintenance costs and the fastest return on investment of any flame atomic absorption (AA) spectrometer. Plus, it's the world's first completely corrosion-resistant flame AA, designed to withstand the harshest environments and most corrosive samples.

The PinAAcle 500 is designed for:

- Exceptional sensitivity and precision, allowing analysis of lower concentrations with the accuracy of higher-end AA systems
- Fast, simple, reproducible operation through the intuitive, icon-based interface of Syngistix Touch™ or Syngistix™ for AA software
- Harsh environments and challenging samples thanks to its corrosion-resistant design
- Minimum maintenance and maximum speed, reducing operating costs

For more information, visit www.perkinelmer.com/PinAAcle500



PinAAcle 900 Series AA

The PinAAcle™ 900 series brings AA performance to new heights. Available in flame, furnace or combination models, PinAAcle 900 instruments offer exactly the level of performance you need with the smallest footprint of any combined flame/graphite furnace AA system on the market.

The PinAAcle 900 series includes:

- Flame, furnace, flow injection, FIAS-furnace and mercury/hydride capabilities on a single instrument
- Choice of Deuterium or longitudinal Zeeman furnace configurations
- Cutting-edge fiber optics to maximize light throughput for improved detection limits
- TubeView™ color furnace camera simplifies autosampler tip alignment and sample dispensing

For more information, visit www.perkinelmer.com/PinAAcle900



Avio 200 ICP-OES

The smallest ICP on the market, the Avio® 200 with vertical plasma dual view technology is designed to deliver high performance, efficient operation, reliable data and low cost of ownership.

The Avio 200 offers:

- Fastest ICP startup (spectrometer ready in just minutes from power on)
- Lowest argon consumption of any ICP – at least 50% lower than other systems
- Greater uptime and sample throughput with PlasmaShear's maintenance-free design
- Unsurpassed matrix tolerance with vertical torch design
- Superior sensitivity and resolution for all elements of interest
- Extended linear range with dual view technology

For more information, visit www.perkinelmer.com/Avio200



Avio 500 ICP-OES

The Avio® 500 is a truly simultaneous, dual view and compact ICP-OES. It utilizes a vertical plasma and is engineered to handle even the most difficult samples, delivering productivity, high performance and faster return on your investment.

The Avio 500 provides:

- Lowest argon consumption of any ICP – at least 50% lower than other systems
- Simultaneous background correction for faster sample-to-sample time and improved data accuracy
- Greater uptime and sample throughput with PlasmaShear's maintenance-free design
- Unsurpassed matrix tolerance with vertical torch design
- Simultaneous detection of all wavelengths at all times with no storage or sample time penalty with Universal Data Acquisition
- High throughput enabled by dual view technology, simultaneous data acquisition and low routine maintenance

For more information, visit www.perkinelmer.com/Avio500



NexION 1000 ICP-MS

The NexION® 1000 ICP-MS offers exceptional speed, operational simplicity and improved laboratory efficiency – the ideal solution for high-throughput labs running routine, multi-elemental, trace-level analyses.

The NexION 1000 features:

- Dedicated SMARTintro™ sample introduction module with integrated AMS for high dissolved solids
- Three quadrupoles and the Universal Cell's ability to switch between Collision and Reaction modes with a single gas offer efficient interference removal, requiring minimal switching times
- Extended Dynamic Range to detect high- and low-level elements in a single sample run
- Industry's fastest data acquisition speed (100,000 points/sec) to handle any particle size
- Triple Cone Interface with Quadrupole Ion Deflector deliver no maintenance beyond the cones

For more information, visit www.perkinelmer.com/NexION1000



NexION 2000 ICP-MS

A very versatile ICP-MS, the NexION® 2000 offers the most powerful interference removal for the best detection limits, the highest flexibility regardless of matrix, the most efficient analysis every time, and the lowest maintenance requirements for ICP-MS.

The NexION 2000 boasts:

- SMARTintro™ sample-introduction modules that simplify operator setup, streamlining your workflows
- Extended Dynamic Range to detect high- and low-level elements in a single sample run
- Three quadrupoles, three gas channels and three modes of operation combine to offer better interference removal, delivering better detection limits/ improved data accuracy
- Industry's fastest data acquisition speed (100,000 points/sec) to handle any particle size
- Triple Cone Interface with Quadrupole Ion Deflector deliver no maintenance beyond the cones

For more information, visit www.perkinelmer.com/NexION2000

Atomic Absorption

PerkinElmer offers a wide selection of superior quality products designed to work with your PerkinElmer instruments. Our precision designed products deliver the peace of mind that comes from knowing that you'll get the results you need.

Quick Reference Index Page

▶ Lumina Hollow Cathode Lamps	14
▶ System 2 Electrodeless Discharge Lamps	16
▶ Atomax Hollow Cathode Lamps	18
▶ Burner System Components	20
▶ Nebulizers	22
▶ Autosampler Cups and Supplies	28
▶ Air Compressors	29
▶ THGA Graphite Tubes	30
▶ HGA Graphite Tubes	32
▶ AA Graphite for Non-PerkinElmer Instruments	34
▶ Mercury Analyzer Supplies	35
▶ Flow Injection System Supplies	36
▶ Mercury/Hydride Systems and Supplies	39

Hollow Cathode and Electrodeless Discharge Lamps

PerkinElmer has over 40 years of expertise designing and manufacturing Hollow Cathode Lamps. PerkinElmer offers a full range of single-element and multi-element Hollow Cathode Lamps and high intensity Electrodeless Discharge Lamps for those elements for which they are more effective.



▶ [VIEW PAGE](#)

Nebulizers

Nebulizers are a critical part of the Flame AA sample introduction system and our nebulizers are designed to support a variety of samples.



▶ [VIEW PAGE](#)

Graphite Furnace Autosampler Supplies

To keep your Graphite Furnace Autosampler operating smoothly, PerkinElmer offers a complete selection of consumables and supplies.



▶ [VIEW PAGE](#)

HGA and THGA Graphite Components

The heart of the Furnace AA system is not only the furnace itself but the graphite components that go into it. Our exclusive PerkinElmer graphite products provide the performance and consistency that furnace applications require.



▶ [VIEW PAGE](#)

Flow Injection System Supplies

PerkinElmer offers a complete line of genuine replacement parts for the FIAS, FIMS and MHS systems.



▶ [VIEW PAGE](#)

▶ [TABLE OF CONTENTS](#)

▶ [ORDER ONLINE](#)

▶ [CLICK THE ARROWS TO VIEW EACH PAGE](#)



IMPROVES BOTH
WORKFLOWS
& CASHFLOWS



NEW PinAAcle 500 Flame AA

Reliability, sensitivity, affordability—*together at last* in a Flame AA.

With the new PinAAcle™ 500, you can experience an uncompromising level of performance for an unbeatable price. The world's first Flame AA system engineered for complete corrosion resistance, the PinAAcle 500 offers superior durability, longer life, lower maintenance costs, and the fastest return on investment of any Flame AA.

Discover an instrument designed to outlast and outperform. And take your laboratory to a new PinAAcle of productivity and profitability.

www.perkinelmer.com/PinAAcle500

Lumina Hollow Cathode Lamps



PerkinElmer has over 40 years of expertise designing and manufacturing Hollow Cathode Lamps

Features and Benefits:

- **Long Life:** PerkinElmer's larger lamp volume results in longer lamp lifetime
- **Automation:** PerkinElmer coded lamps allow automatic setup
- **Electronic Lamp Timer:** When combined with a PinAAcle instrument and Syngistix Software the lamp life is automatically recorded for easy viewing
- **Easy Installation:** It's as simple as sliding the lamp into the instrument's lamp bracket or turret
- **Complete Compatibility:** Lumina hollow cathode lamps can be used with PerkinElmer's entire range of atomic absorption spectrometers
- **Testing:** Every lamp is thoroughly tested before leaving the factory
- **Quality:** Carefully selected materials used in the manufacturing of our lamps avoid spectral interference
- **Design:** Our design provides you with the low detection limits needed for your most difficult determinations
- **Selection:** PerkinElmer offers a wide selection of single-element and multi-element lamps
- **Easy To Order:** It's easy to find the right lamp for your analytical needs – simply use the selection charts on this page or visit our website for a complete listing
- **Warranty:** The performance of every PerkinElmer lamp is fully warranted* (see next page for details).

Lumina Single-Element Hollow Cathode Lamps

Element Name	Element Symbol	Lumina Lamp Part No.	Lumina Lamp with Intensitron® Adapter Part No.
Aluminum	Al	N3050103	N3050303
Antimony	Sb	N3050170	N3050370
Arsenic	As	N3050105	N3050305
Barium	Ba	N3050109	N3050309
Beryllium	Be	N3050110	
Bismuth	Bi	N3050111	
Boron	B	N3050108	
Cadmium	Cd	N3050115	N3050315
Calcium	Ca	N3050114	N3050314
Chromium	Cr	N3050119	N3050319
Cobalt	Co	N3050118	
Copper	Cu	N3050121	N3050321
Dysprosium	Dy	N3050122	
Erbium	Er	N3050123	
Europium	Eu	N3050124	
Gadolinium	Gd	N3050129	
Gallium	Ga	N3050128	
Germanium	Ge	N3050130	
Gold	Au	N3050107	
Hafnium	Hf	N3050133	
Holmium	Ho	N3050135	
Indium	In	N3050137	
Iridium	Ir	N3050138	
Iron	Fe	N3050126	N3050326
Lanthanum	La	N3050141	
Lead	Pb	N3050157	N3050357
Lithium	Li	N3050142	
Magnesium	Mg	N3050144	N3050344
Manganese	Mn	N3050145	N3050345
Mercury	Hg	N3050134	
Molybdenum	Mo	N3050146	
Neodymium	Nd	N3050150	
Nickel	Ni	N3050152	N3050352
Niobium	Nb	N3050149	
Palladium	Pd	N3050158	
Phosphorus	P	N3050155	
Platinum	Pt	N3050162	
Potassium	K	N3050139	N3050339
Praseodymium	Pr	N3050161	
Rhenium	Re	N3050165	N3050365
Rhodium	Rh	N3050166	
Ruthenium	Ru	N3050168	

Chart continues on next page

Element Name	Element Symbol	Lumina Lamp Part No.	Lumina Lamp with Intensitron® Adapter Part No.
Samarium	Sm	N3050174	
Scandium	Sc	N3050171	
Selenium	Se	N3050172	
Silicon	Si	N3050173	
Silver	Ag	N3050102	N3050302
Sodium	Na	N3050148	N3050348
Strontium	Sr	N3050176	
Tantalum	Ta	N3050177	
Tellurium	Te	N3050180	
Terbium	Tb	N3050178	
Thallium	Tl	N3050183	
Thulium	Tm	N3050184	
Tin	Sn	N3050175	
Titanium	Ti	N3050182	
Tungsten	W	N3050187	
Vanadium	V	N3050186	
Ytterbium	Yb	N3050190	
Yttrium	Y	N3050189	
Zinc	Zn	N3050191	N3050391
Zirconium	Zr	N3050192	

PERKINELMER EXCLUSIVE 6/24 WARRANTY*

Lumina™ Hollow Cathode Lamps

1. We warrant that during the first six months or after 5,000 milliampere-hours of operation, whichever comes first, from initial date of shipment, the lamps will meet or exceed the intensity and absorption specifications to which all new lamps are tested.
2. All our hollow cathode lamps are warranted to light and emit the spectra of the element indicated for two years or 5,000 milliampere-hours of operation from the date of the shipment, whichever comes first.
3. If any lamp fails before the expiration of the warranty period, it will be replaced free of charge.

*The lamp warranty is void for lamps which sustain physical damage or are operated at power levels substantially above or below the power level recommended on the lamp label. The lamp warranty may vary in different countries.

Lumina Multi-Element Hollow Cathode Lamps

Element Name	Element Symbol	Lumina Lamp Part No.
Two-element Lamps		
Silver, Gold	Ag, Au	N3050201
Calcium, Magnesium	Ca, Mg	N3050202
Calcium, Zinc	Ca, Zn	N3050203
Potassium, Sodium	K, Na	N3050204
Platinum, Ruthenium	Pt, Ru	N3050205
Tin, Tellurium	Sn, Te	N3050206
Three-element Lamps		
Calcium, Magnesium, Zinc	Ca, Mg, Zn	N3050208
Copper, Iron, Nickel	Cu, Fe, Ni	N3050209
Four-element Lamps		
Copper, Iron, Manganese, Zinc	Cu, Fe, Mn, Zn	N3050212
Five-element Lamps		
Silver, Chromium, Copper, Iron, Nickel	Ag, Cr, Cu, Fe, Ni	N3050213
Cobalt, Chromium, Copper, Manganese, Nickel	Co, Cr, Cu, Mn, Ni	N3050214
Six-element Lamps		
Cobalt, Chromium, Copper, Iron, Manganese, Nickel	Co, Cr, Cu, Fe, Mn, Ni	N3050217
Seven-element Lamps		
Aluminum, Calcium, Copper, Iron, Magnesium, Silicon, Zinc	Al, Ca, Cu, Fe, Mg, Si, Zn	N3050218

Electrodeless Discharge Lamps



Features and Benefits:

- **Brightness:** EDLs are much brighter and, in some cases, provide better sensitivity than comparable hollow cathode lamps
- **Precision:** EDLs offer lower detection limits and are preferred for analyses that are 'noisy' due to weak hollow cathode emission
- **Long Life:** System 2 EDLs are long-lived for exceptional cost-effectiveness
- **Automation:** PerkinElmer coded lamps allow automatic set-up on systems with automated turret
- **Quality:** Carefully selected materials used in the manufacturing of our lamps avoid spectral interference
- **Testing:** Every lamp is thoroughly tested
- **Design:** Our design provides you with the low detection limits needed for your most difficult determinations
- **Warranty:** The performance of every PerkinElmer lamp is fully warranted*

EDLs provide greater light output and longer life than corresponding HCLs

For certain elements such as Arsenic and Selenium, EDLs will also provide improved sensitivity and lower detection limits. System 2 electrodeless discharge lamps provide the optimized spectral output needed to get the maximum performance from PerkinElmer atomic absorption spectrometers.

EDLs are typically much brighter and, in some cases, provide better sensitivity than comparable HCLs. EDLs are preferred for certain volatile elements. They offer better precision and lower detection limits for analyses that are 'noisy' due to weak hollow cathode emission. PerkinElmer System 2 EDLs consist of the element or a salt of the element sealed in a quartz bulb containing an inert gas atmosphere. When an RF field of sufficient power is applied, the inert gas is ionized and the coupled energy vaporizes the element and excites the atoms inside the bulb, resulting in the emission of the characteristic spectrum.

PerkinElmer's System 2 EDLs consist of a driver and a lamp sleeve. Depending on the instrument, one or two EDL lamps can be on at the same time. The driver connects to the instrument's RF power supply (if applicable), or the external power supply if needed. The lamp sleeve contains the pre-aligned bulb for the element of interest. The sleeve has the same exterior dimensions as the PerkinElmer HCLs, allowing System 2 EDLs to be used in the same lamp mounts and turrets.

The locking pin on the lamp driver prevents operation without the lamp sleeve correctly installed on the driver.

Electrodeless Discharge Lamps are an ideal source for determining volatile elements.

PERKINELMER EXCLUSIVE WARRANTY*

System 2 Electrodeless Discharge Lamps

1. We warrant that during the first six months or after 500 hours of operation, whichever comes first, from initial date of shipment, the lamps will meet or exceed the intensity and absorption specifications to which all new lamps are tested.
2. All our Electrodeless Discharge Lamps are warranted to light and emit the spectra of the element indicated for two years or 1,000 hours of operation from the initial date of shipment, whichever comes first.
3. If any lamp fails before the expiration of the warranty period, it will be replaced free of charge.

* The lamp warranty is void for lamps that sustain physical damage or are operated at power levels substantially above or below the power level recommended on the lamp label. The lamp warranty may vary in different countries.



System 2 EDL
with Coded Adapter



Analyst
Coded Adapter

Electrodeless Discharge Lamps

Element Name	Element Symbol	System 2 EDL with Coded Adapter Part No.	AAAnalyst Coded Adapter Part No.
Antimony	Sb	N3050670	N3050869
Arsenic	As	N3050605	N3050860
Bismuth	Bi	N3050611	N3050861
Cadmium	Cd	N3050615	N3050862
Cesium	Cs	N3050620	N3050863
Germanium	Ge	N3050630	N3050864
Lead	Pb	N3050657	N3050867
Mercury	Hg	N3050634	N3050865
Phosphorus	P	N3050655	N3050866
Rubidium	Rb	N3050664	N3050868
Selenium	Se	N3050672	N3050870
Tellurium	Te	N3050680	N3050872
Thallium	Tl	N3050683	N3050873
Tin	Sn	N3050675	N3050871
Zinc	Zn	N3050691	N3050874

EDL Driver Assembly required



EDL Driver Assembly
Part No. **03030997**

EDL Driver Assemblies

Description	Part No.
For AAAnalyst™ 200/400	N3150131
EDL Lamp Adapter AAAnalyst 200/400 to PinAAcle Adapter cable to allow custom AAAnalyst 200/400 EDL lamp drivers to plug into PinAAcle instruments	N3180626
System 2 EDL driver with a short cable For use with PinAAcle and other instruments that have a built in EDL power supply. Adapter N3150303 is also needed if used on the AAAnalyst 200/400	03030997
Driver with a long cable For use with the external power supply, but has the same plug connector as 03030997 . Requires adapter N3150303 if used with the AAAnalyst 200/400	03030793

EDL Driver Components

Description	Part No.
Driver Assembly Adapter Cable Allows System 2 EDL Drivers (03030793 and 03030997) to be used on an AAAnalyst 200/400	N3150303
Extension cable for 03030997 if a longer length is needed	03030998

Background Corrector Sources

For Instrument Models	Source Type	Part No.
PinAAcle 500/900	Deuterium	N3160811
AAAnalyst 200/400	Deuterium	B3150169
AAAnalyst 700/800	Deuterium	B0148615

Lamp Adapters and Supplies

Small Diameter Lamp Adapter Kit

Permits the use of hollow cathode lamps of smaller diameter than the PerkinElmer 2 in. diameter hollow cathode lamps used in PerkinElmer atomic absorption spectrometers. Note that the adapter has an 8-pin connector for the lamp and the cable terminates with a 9-pin connector which requires **N3050197** to be compatible with AAAnalyst and PinAAcle instruments.



Small Diameter Lamp Adapter Kit
Part No. **N3051050**

For a full selection of Lamp Adapters and supplies please visit our website.

Description	Part No.
Small Diameter Lamp Adapter Kit	N3051050

Non-Coded Intensitron Lamp Plug Adapter

Allows non-coded Intensitron lamps (03036XXX series, 9-pin) and other 9-pin lamps to be used with PinAAcle and AAAnalyst instruments (4-pin).



Non-Coded Intensitron
Lamp Plug Adapter
Part No. **N3050197**

Description	Part No.
Non-Coded Intensitron Lamp Plug Adapter	N3050197

Red Filter

Linearizes working curves for potassium, lithium, rubidium and cesium. Recommended for Rb and Cs determinations by flame emission. Passes only wavelengths longer than 650 nm.

Description	Part No.
Red Filter	02901518

Atomax Hollow Cathode Lamps



Atomax™ 1.5 in. AA Lamps from PerkinElmer, the World Leader in Atomic Absorption

Atomax 1.5 in. hollow cathode lamps are crafted to the same high standards that have made PerkinElmer 2 in. Lumina™ hollow cathode lamps the best in the industry. Drawing on more than 40 years of HCL design and manufacturing expertise, Atomax lamps now offer laboratories around the world a dependable, top-quality lighting source, regardless of the brand of AA instruments used.

Value-Priced and Fully Compatible with 1.5 in. Format AA Instruments

PerkinElmer 2-pin non-coded Atomax lamps are designed to fit most commercially available atomic absorption instruments including Agilent®, Thermo®, Shimadzu®, GBC®, Analytic Jena®, Hitachi® and many more. Combining affordability and industry-wide compatibility allows users of other brands of AAs to benefit from PerkinElmer's proven lamp performance. Each lamp is thoroughly tested to ensure that it will stand up to the most demanding requirements. Atomax lamps represent an exceptional value and our money-back guarantee means you can order with complete confidence.

Tested and Validated for Highest Quality Performance

All 1.5 in. Atomax hollow cathode lamps are thoroughly tested to ensure maximum light output and spectral purity. Comparative results show that Atomax lamps provide equal or better performance than other AA lamps in the market. Precision engineered for high sensitivity, stable light output, low noise, and long life, you can rely on Atomax lamps for the accurate results you need.

Features and Benefits:

- **Experts:** Expertise designing and manufacturing quality lamps for over 40 years. A brand you can trust
- **Compatibility:** Compatible with other manufacturer's instruments – tested and approved
- **Lifetime:** Long lifetime and performance. As the world's leading AA supplier, we know how to build lamps that provide maximum light output and spectral purity for optimum performance
- **Quality:** Every lamp ships with Certificate of Quality
- **Testing:** Lamps are thoroughly tested before leaving the factory
- **Raw Materials:** Carefully selected materials used in the manufacturing of our lamps avoid spectral interference
- **Clean:** Lamps are built to stringent specifications in a state-of-the-art lamp manufacturing facility. Great quality every time
- **Design:** Our design provides you with the low detection limits needed for your most difficult determinations
- **Value:** Equivalent or better performance than your current lamp at a great price

Every Atomax lamp includes a certificate of quality, our promise of outstanding performance levels from the leader in AA.





PERKINELMER EXCLUSIVE 6/24 WARRANTY*

Atomax™ Hollow Cathode Lamps

1. We warrant that during the first six months for 5,000 milliampere-hours of operation, whichever comes first, from initial date of shipment, the lamps will meet or exceed the intensity and absorption specifications to which all new lamps are tested.
2. All of our hollow cathode lamps are warranted to light and emit the spectra of the element indicated for two years or 5,000 milliampere hours of operation from the date of the shipment, whichever comes first.
3. If any lamp fails before the expiration of the warranty period, it will be replaced free of charge.

* The lamp warranty is void for lamps which sustain physical damage or are operated at power levels substantially above or below the power level recommended on the lamp label. The lamp warranty may vary in different countries.

Element	Symbol	Part No.
Aluminum	Al	N2025301
Antimony	Sb	N2025347
Arsenic	As	N2025302
Barium	Ba	N2025305
Beryllium	Be	N2025306
Bismuth	Bi	N2025307
Boron	B	N2025304
Cadmium	Cd	N2025309
Calcium	Ca	N2025308
Cesium	Cs	N2025312
Chromium	Cr	N2025311
Cobalt	Co	N2025310
Copper	Cu	N2025313
Dysprosium	Dy	N2025314
Erbium	Er	N2025315
Europium	Eu	N2025316
Gadolinium	Gd	N2025319
Gallium	Ga	N2025318
Germanium	Ge	N2025320
Gold	Au	N2025303
Hafnium	Hf	N2025321
Holmium	Ho	N2025323
Indium	In	N2025324

Element	Symbol	Part No.
Iridium	Ir	N2025325
Iron	Fe	N2025317
Lanthanum	La	N2025327
Lead	Pb	N2025339
Lithium	Li	N2025328
Lutetium	Lu	N2025329
Magnesium	Mg	N2025330
Manganese	Mn	N2025331
Mercury	Hg	N2025322
Molybdenum	Mo	N2025332
Neodymium	Nd	N2025335
Nickel	Ni	N2025336
Niobium	Nb	N2025334
Osmium	Os	N2025337
Palladium	Pd	N2025340
Phosphorus	P	N2025338
Platinum	Pt	N2025342
Potassium	K	N2025326
Praseodymium	Pr	N2025341
Rhenium	Re	N2025344
Ruthenium	Ru	N2025346
Rhodium	Rh	N2025345
Rubidium	Rb	N2025343

Element	Symbol	Part No.
Samarium	Sm	N2025351
Scandium	Sc	N2025348
Selenium	Se	N2025349
Silicon	Si	N2025350
Silver	Ag	N2025300
Sodium	Na	N2025333
Strontium	Sr	N2025353
Tantalum	Ta	N2025354
Terbium	Tb	N2025355
Tellurium	Te	N2025356
Thallium	Tl	N2025359
Thorium	Th	N2025357
Thulium	Tm	N2025360
Tin	Sn	N2025352
Titanium	Ti	N2025358
Tungsten	W	N2025362
Vanadium	V	N2025361
Ytterbium	Yb	N2025364
Yttrium	Y	N2025363
Zinc	Zn	N2025365
Zirconium	Zr	N2025366

Graphite for Non-PerkinElmer Instruments can be found in the graphite section.

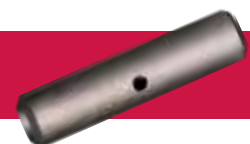

Burner System Components



An efficient burner system is essential for obtaining optimal performance from your AA instrument, and proper maintenance is required to obtain precise and accurate determinations.

Features and Benefits:

- 100% titanium burner heads, an exclusive PerkinElmer feature that provides maximum corrosion resistance when analyzing any type of sample
- Burner chambers constructed of inert, wettable plastic to allow for proper drainage of excess sample and minimize sample carryover from previous analyses
- Multivaned flow spoilers remove large sample droplets from the nebulized spray and reduce susceptibility to analytical interference
- Gaskets designed for use with aqueous and organic samples. Choose from synthetic rubber gaskets for aqueous solutions and Corkprene or KALREZ gaskets for organic solutions
- PinAAcle uses the same Burner Heads as AAnalyst series. The latest design has a hole on the rim for ease of rotation during operation. The handle is provided with the instrument

Burner Heads

Single-slot Nitrous Oxide-acetylene 5 cm

The 5 cm nitrous oxide burner head is required for nitrous oxide-acetylene operation. This burner head can also be used with air-acetylene or rotated to provide reduced sensitivity.

Description	Part No.
Single-slot Nitrous Oxide-acetylene 5 cm	N0400100

Single-slot Air-acetylene 10 cm

The 10 cm burner head is designed to be used with the air-acetylene flame. Because of its long burner path length, it provides the best sensitivity for air-acetylene elements. This is the standard burner head that is shipped with all PinAAcle flame instruments.

Description	Part No.
Single-slot Air-acetylene 10 cm	N0400102

Single-slot Air-acetylene 5 cm

A 5 cm air-acetylene burner head is available for applications in which reduced sensitivity is required. It can be rotated to provide further sensitivity reduction, and it has a wide slot to prevent clogging.

Description	Part No.
Single-slot Air-acetylene 5 cm	N0400101

Three-slot Air-acetylene 10 cm

The three-slot burner head is designed to be used when analyzing samples with high concentrations of dissolved solids. The three-slot burner head is not compatible with some older gas control systems.

Description	Part No.
Three-slot Air-acetylene 10 cm	N0400103

Burner Head Cleaning Tool

Description	Part No.
Burner Head Cleaning Tool	03031573

Burner Head Adjustment Tool

Description	Part No.
Burner Head Adjustment Tool	N3161240

Single-slot Nitrous Oxide-acetylene 5 cm



Single-slot Air-acetylene 5 cm



Single-slot Air-acetylene 10 cm



Three-slot Air-acetylene 10 cm



Burner Head Adjustment Tool



PinAAcle Burner System Components

- 1** Burner Head
- 2** Burner Head O-Ring
- 3** Mixing Chamber
- 4** Flow Spoiler
- 5** End Cap Assembly
- 6** Stainless Steel Nebulizer
- 7** Retaining Ring
- 8** Burner Head Adjustment Tool

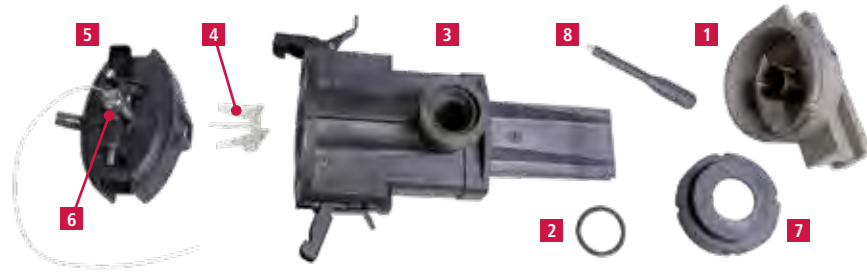

PinAAcle Burner System Components

Burner System Components

Description	PinAAcle 500/900 Part No.	AAnalyst 100/200/300/400/700/800 Part No.
Viton Burner Head O-Ring Kit, 0.984 in. x 0.139 in. 09200079 O-Ring (3), 09200078 Super O-Lube (1)	09902219	09902219
Burner Mixing Chamber Assembly (Note: PinAAcle assembly includes components 2, 3 and 7; AAnalyst component 2 only.)	N3160506	00570948
Burner Chamber Holder	N3160809	
Clamping Ring		N0401171
Flow Spoiler	00572561	00572561
Viton O-Ring for End Cap Gas Lines (Neb., Aux., Fuel) 0.312 in. x 0.070 in. (Qty. 4 required)	09200253	
Viton O-Ring for End Cap 1.892 in. x 0.103 in.	09902147	09902147
Kalrez O-Ring for End Cap Gas Lines (Neb., Aux., Fuel) 0.312 in. x 0.070 in. (Qty. 4 required)	09200275	
Kalrez O-Ring for End Cap 1.892 in. x 0.103 in.	09200277	09200277
Organics (Corkprene) O-Ring for End Cap	00472014	00472014
End Cap Assembly with Viton O-Rings (for use with metal body nebulizers)	N3160505	00570984
End Cap Assembly with Kalrez O-Rings (for use with metal body nebulizers)	N3160188	
End Cap Assembly with Viton O-Rings (for use with plastic body nebulizers)	N3160511	N0370392
End Cap Assembly with Kalrez O-Rings (for use with plastic body nebulizers)	N3160189	
End Cap Assembly Impact Bead (for use with metal body nebulizers)	N3160545	
Burner Gasket Kit for End Cap Assembly 00570984 ; 00472014 (5), 09902147 (3), 09902219 (1), 09902236 (3), 09902240 (3)		00470988
Drain Tubing – Tygon Tubing with FEP lining	02507987	02507987
Pyrex Impact Bead Used with End Caps for Metal Body Nebulizers	00572615	00572615
Seal Plug for the 00572615 Pyrex Impact Bead used with end caps for metal body nebulizers	N3161224	00572624
O-Ring for seal plug in end caps with Impact Bead (Qty. 2 required)	09902236	09902240
Burner Drain Assembly for Organic Solutions	N3160683***	N3150230*
Burner Drain Assembly (includes tubing and drain interlock, drain bottle 09200486 not included)		N2011074*
Burner Drain Assembly (includes tubing and drain interlock, drain bottle 09200486 not included)	N0400058***	N0400058**
Wide Mouth 15 L Drain Bottle	09200486	09200486

*For AAnalyst 700/800, **For AAnalyst 200/400, ***Also compatible with AAnalyst 100/200/300/400

AAAnalyst Burner System Components

- 1** Burner Head
- 2** Burner Mixing Chamber
- 3** Clamping Ring
- 4** Flow Spoiler
- 5** End Cap O-Ring
- 6** End Cap Assembly

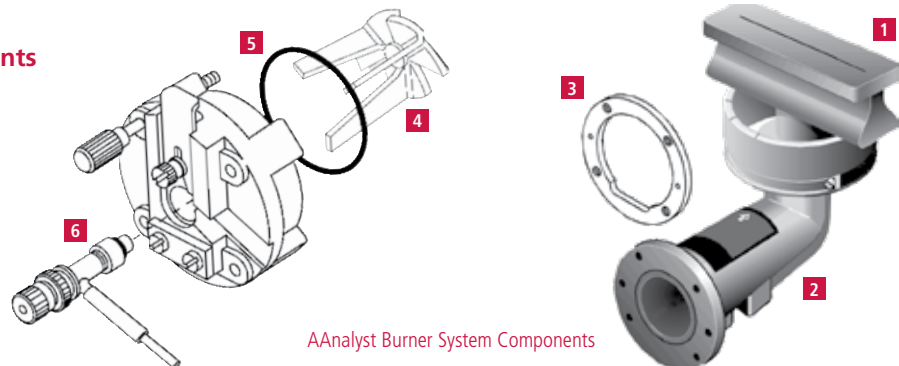

AAAnalyst Burner System Components

Nebulizers



PinAAcle Removable Burner Assembly allows switching between analytical techniques in a matter of seconds on flame/furnace combination instruments



PinAAcle High-Sensitivity Nebulizer
Part No. N3160144



High-Sensitivity Nebulizer
with Pt/Ir Capillary

The nebulizer is one of the most important components in a flame AA spectrometer

Sample solutions, with differing physical properties, must be converted into an aerosol of small, similarly-sized droplets. This places great demands on the design of the nebulizer.

All PerkinElmer nebulizer assemblies are adjustable for optimized performance and include easily-interchanged capillary assemblies for simple, reduced-cost maintenance. PerkinElmer nebulizers are manufactured to exacting tolerances to provide maximum sensitivity. Universal, or, 'standard' nebulizers are less expensive than the corresponding high-sensitivity nebulizers and provide a lower level of sensitivity. The universal, or, 'standard' nebulizers typically provide better precision and reduced 'carryover' interference when used with solutions that contain high dissolved solids content of higher analyte concentrations.

High-Sensitivity Nebulizer with Pt/Ir Capillary

Our high-precision nebulizer maximizes stability and sensitivity, even for the toughest matrices. The nebulizer is adjustable so a wide variety of sample matrices – aqueous or organic, acidic or basic, diluted or concentrated – can be analyzed under optimum conditions. This high-sensitivity nebulizer is fabricated with inert plastic materials for maximum performance and corrosion resistance.



High-Sensitivity Nebulizer

- Provides maximum sensitivity, precision and freedom from analytical interferences
- The high-sensitivity nebulizer with platinum/iridium capillary is for most solutions, but not for precious metal samples containing aqua regia
- High-sensitivity nebulizer with tantalum capillary used for solutions containing aqua regia



Metal Body Corrosion-Resistant Nebulizers

- For all solutions containing hydrofluoric acid or aqua regia
- For all solutions containing high concentrations of dissolved solids
- All internal components in contact with solutions are constructed of plastic to resist corrosion from concentrated acids
- Reduced performance compared with stainless steel or platinum/rhodium nebulizers



Metal Body Platinum Alloy Nebulizers

- Recommended for most concentrated acids containing >5% acid
- Includes a platinum alloy needle assembly and a tantalum venturi
- Provides maximum chemical resistance
- Not suitable for use with aqua regia or hydrofluoric acid



Plastic Body GemTip™ Nebulizers

- Corrosion-resistant and can be used to aspirate almost all solutions, even those solutions containing a high percentage of acids
- Designed to obtain optimum sensitivity, detection limits and precision with flame atomic absorption for both air-acetylene and nitrous oxide-acetylene flames



Metal Body Stainless Steel Nebulizers

- For most solutions containing <5% acid, providing exceptional performance and durability
- Excellent performance (precision and signal-to-noise ratio)



Nebulizer Assemblies and Spares

Metal Body Nebulizer Parts for PinAAcle AA Instruments

For Nebulizers with Part Nos. **N3160143** and **N3160158**

Description	Part No.
1 O-Ring sealing Nebulizer to End Cap Solvent Resistant O-Ring Sealing Nebulizer to End Cap	09926068 09200274
2 Cap	N3161057
3 Venturi	03031810
4 O-Ring for Venturi Solvent Resistant O-Ring for Venturi	09902047 09200273
5 O-Rings for Nebulizer Body (Each nebulizer requires a quantity of 2) Solvent Resistant O-Rings for Nebulizer Body (Each nebulizer requires a quantity of 2)	09902015 09200276
6 Nebulizer Body	N3160133
7 Nebulizer Insert	03031812
8 O-Ring for Nebulizer Insert Solvent Resistant O-Ring for Nebulizer Insert	09902047 09200273
9 Locking Ring	N3161006
10 Spring	03031806
11 O-Ring for Capillary Needle Assembly Solvent Resistant O-Ring for Capillary Needle Assembly	09902102 09200271
12 Capillary Needle Assembly with O-Ring Solvent Resistant Capillary Needle Assembly with O-Ring	03030354 N3160153
13 PTFE Washer	03031802
14 Fine Adjustment Nut	03031460
15 Sample Capillary	09908265

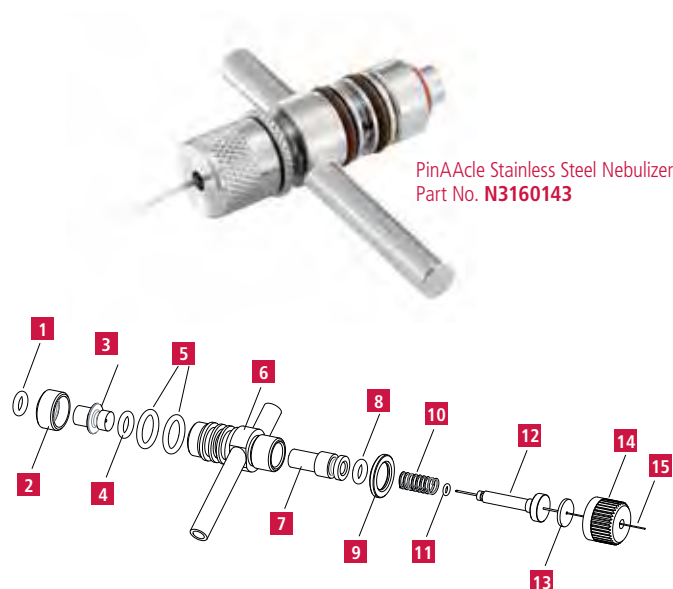

Plastic Body Nebulizer Parts for PinAAcle AA Instrument

For Nebulizers with Part Nos. **N3160144**, **N3160152** and **N3160159**

Description	Part No.
1 Impact Bead	B0505086
2 Spacer	B3150531
3 O-Rings for Nebulizer Body (Each nebulizer requires a quantity of 2) Solvent Resistant O-Rings for Nebulizer Body (Each nebulizer requires a quantity of 2)	09902015 09200276
4 Plastic Nebulizer Body	
5 Spring	09920483
6 Locking Ring	N3151205
7 O-Ring for Capillary Needle Assembly Solvent Resistant O-Ring for Capillary Needle Assembly	09926127 09200272
8 Pt/Ir Capillary Needle Assembly with Spring and O-Ring Solvent Resistant Pt/Ir Capillary Needle Assembly with Spring and O-Ring	B3150525 N3160154
9 Fine Adjustment Nut	B3150462
10 Sample Tubing	B3150458

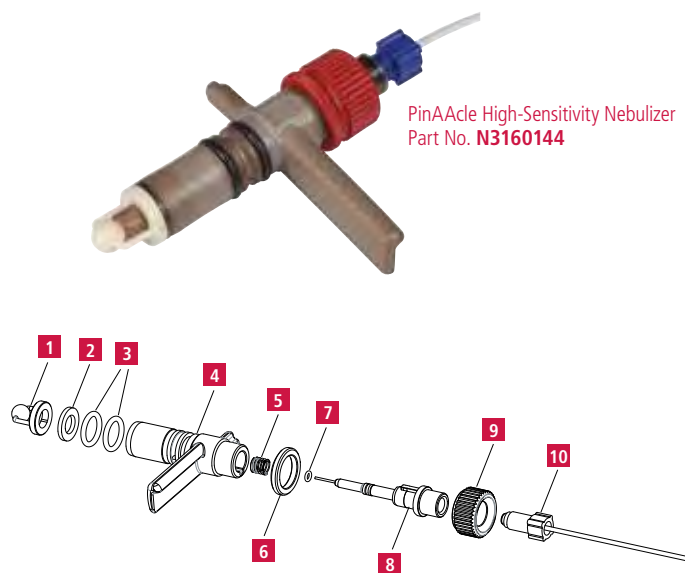

Plastic Body Nebulizer Parts for AAnalyst AA Instruments

AAnalyst 100/300/200/400/700/800* High-Sensitivity Nebulizer Parts

For Nebulizers with Part Nos. **B0505480** and **B0505590**

Description	Part No.
1 Impact Bead	B0505086
2 Solvent Resistant O-Ring for Nebulizer Body	B0174378
3 Nebulizer Body	B0506666
4 Spring	B0165332
5 Solvent Resistant O-Ring for Capillary Assembly	B0190672
6 Pt/Ir Capillary Assembly	B0501022
7 Locking Ring	B0501025
8 Fine Adjustment Nut	B0501026

*This nebulizer requires the use of end cap assembly

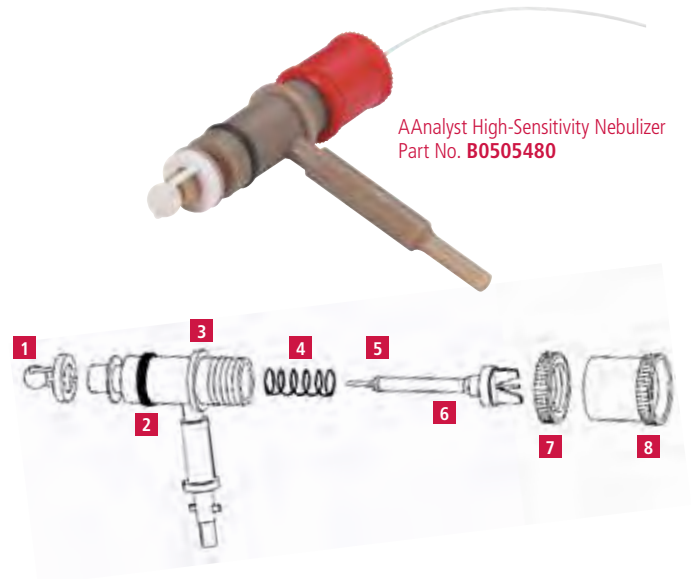

AAnalyst 200/400/700*/800* High-Sensitivity Nebulizer Parts

For Nebulizers with Part Nos. **N3150188** and **N2010250**

Description	Part No.
1 Impact Bead	B0505086
Nebulizer Spacer (not pictured)	B3150531
2 O-Rings for Nebulizer Body (Each nebulizer requires a Qty. of 2)	09902015
Solvent Resistant O-Rings for Nebulizer Body (Each nebulizer requires a Qty. of 2)	09200276
3 Nebulized Body	—
4 Spring	09920483
5 O-Ring for Capillary Assembly	09926127
Solvent Resistant O-Ring for Capillary Assembly	09200272
6 Pt/Ir Capillary Assembly with O-Ring	B3150525
Tantalum Capillary Assembly with Solvent Resistant O-Ring and Spring	N3160146
7 Locking Ring	N3151205
8 Fine Adjustment Nut	B3150462
N/A O-Ring for Sample Tube (Each sample tube requires a Qty. 2)	B0507708
N/A Solvent Resistant O-Ring for Sample Tube (Each sample tube a Qty. 2)	09200369
N/A Solvent Resistant O-Ring Kit (Includes 1 x 09200272 , 2 x 09200276 and 2 x 09200369)	N2010246

*Requires End Cap Assembly **N0370392**

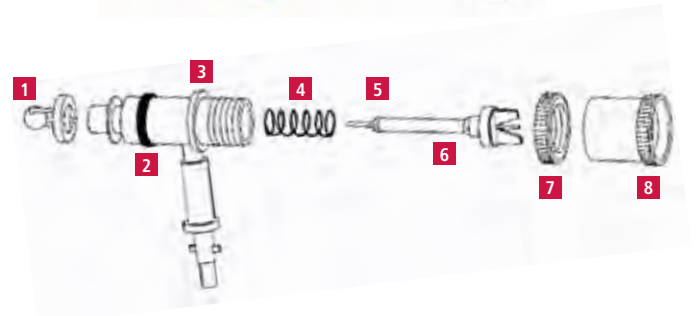

Metal Body Nebulizer Parts for AAnalyst 200/400*, 100/300/700/800**

For Nebulizers with Part Nos. **03030404**, **03030299** and **03030352**

Description	Part No.
1 O-Ring for Insert/Venturi (Each nebulizer requires a quantity of 2)	09902005
Solvent Resistant O-Rings for Insert/Venturi (Each nebulizer requires a quantity of 2)	09200273
2 Insert	03031812
3 Nebulizer Body	03030353
4 Venturi for Corrosion Resistant Nebulizer	03031920
Venturi for Platinum Alloy Nebulizer	03033124
Venturi for Stainless Steel Nebulizer	03031810
5 Front End Cap	03031808
6 O-Ring for Front End Cap	09902239
Solvent Resistant O-Ring for Front End Cap	09200274
7 Fine Adjustment Nut	03031460
8 Locking Ring	03031456
9 Washer	03031802
10 Capillary Assembly for Corrosion Resistant Nebulizer	03030402
Capillary Assembly for Platinum Alloy Nebulizer	03030433
Capillary Assembly for Stainless Steel Nebulizer	03030354
11 O-Ring for Capillary Assembly	09902102
Solvent Resistant O-Ring for Capillary Assembly	09200271
12 Spring	03031806
N/A O-Ring Kit (Includes 5 x 09902005 , 3 x 09902102 , 5 x 09902239 , 2 x 03031802)	N9300065
N/A Solvent Resistant O-Ring Kit (Includes 1 x 09200271 , 2 x 09200273 and 1 x 09200274)	N2010247

* AAnalyst 200/400 Require End Cap **00570984** ** For AAnalyst spectrometers shipped starting Fall 1999



AAnalyst Stainless Steel Nebulizer
Part No. **03030352**

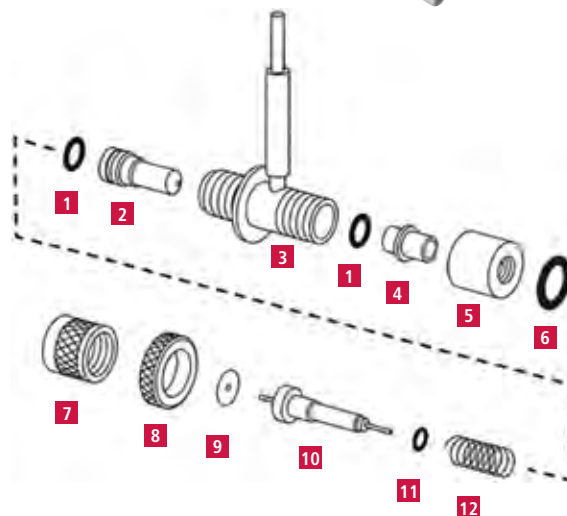

GemTip Nebulizers for AAnalyst 100/300/200*/400*/700**/800**

For Nebulizers with Part Nos. **N0370394** and **N0370393**

Description	Part No.
1 Capillary Tubing	09908265
2 Fine Adjustment Nut	N0371492
3 Gland Nut	N0371505
4 PTFE Tubing	09985708
5 Capillary Assembly for Universal GemTip Nebulizers	N0371520
Capillary Assembly for High-Sensitivity GemTip Nebulizers	N0371522
6 O-Ring for Capillary Assembly	09926083
7 Impact Bead for High-Sensitivity GemTip Nebulizer	B0505086
8 O-Ring for Nebulizer Body	09902015
Solvent Resistant O-Ring for Nebulizer Body	B0174378
9 Body Assembly for Universal GemTip Nebulizer	N0370398
Body Assembly for High-Sensitivity Nebulizer	N0370399
10 Locking Nut	N0371493
11 Spring	09902473
12 Connector Nut	N0371485
13 Magnet Holder Assembly	N1010215

* AAnalyst 200/400 Require End Cap **N0370392** ** For AAnalyst 700/800 Instruments Shipped before Fall 1999



Universal GemTip Nebulizer
Part No. **N0370394**

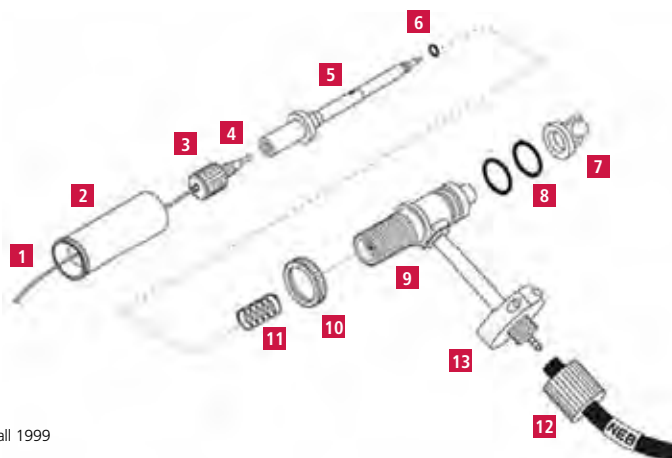

Kalrez O-Ring Kits for Sampling Accessories

Description	Part No.
Nebulizer, End Cap and Burner Head O-Ring Kit for Plastic Nebulizer for PinAAcle AA. Includes: 09200272 (1), 09200275 (4), 09200276 (2), 09200277 (1), 09200278 (1), 09200369 (2)	N3160157
Nebulizer, End Cap and Burner Head O-Ring Kit for Stainless Steel Nebulizer for PinAAcle AA. Includes: 09200271 (1), 09200273 (2), 09200274 (1), 09200275 (4), 09200276 (2), 09200277 (1), 09200278 (1)	N3160156
Nebulizer O-Ring Kit for Stainless Steel Nebulizer for PinAAcle AA. Includes: 09200271 (1), 09200273 (2), 09200274 (1), 09200276 (2)	N3160192
Nebulizer O-Ring Kit, fits Stainless Steel Nebulizers 03030358 and 03030352 . Includes: 09200271 (1), 09200273 (2), 09200274 (1)	N2010247
Nebulizer O-Ring Kit for Plastic Nebulizer for PinAAcle AA. Includes: 09200272 (1), 09200276 (2), 09200369 (2)	N3160193
Nebulizer O-Ring Kit for AA200/400 Nebulizer N2010250 . Includes: 09200272 (1), 09200276 (2), 09200369 (2)	N2010246
End Cap O-Ring Kit for PinAAcle AA. Includes: 09200275 (4), 09200277 (1)	N3160194
End Cap O-Ring Kit for AAAnalyst 700/800 End Cap, 00570984 . Includes: 09200277 (1), 09200341 (2), 09200342 (2)	N2010245

PinAAcle Nebulizers and Assemblies Quick Reference

Description	Type	Needle	O-Ring Type	Complete Assembly	End Cap Assembly	Replacement Needle Assembly
Plastic High Sensitivity (standard)	Aqueous	Platinum/Iridium	Viton	N3160144	N3160511	B3150525
Plastic High Sensitivity	Aqueous or Organics	Platinum/Iridium	Kalrez	N3160159	N3160189	N3160154
Plastic High Sensitivity (suitable for aqua regia in addition to organics)	Aqueous or Organics	Tantalum	Kalrez	N3160152	N3160189	
Stainless Steel (standard)	Aqueous	Stainless	Viton	N3160143	N3160505	03030354
Stainless Steel	Aqueous or Organics	Stainless	Kalrez	N3160158	N3160188	N3160153
Stainless Steel	Aqueous	Plastic	Viton		N3160505	03030402
Stainless Steel	Aqueous	Platinum Alloy	Viton		N3160505	03030133
Description	Type			Burner Drain Assembly	Drain Bottle	
Drain Assembly	Aqueous			N0400058	09200486	
Drain Assembly	Organics			N3160683	09200486	

AAAnalyst Nebulizers and Assemblies Quick Reference

Description	Type	Needle	O-Ring Type	Complete Assembly	End Cap Assembly	Replacement Needle Assembly
High-Sensitivity Plastic Body	Aqueous or Organics	Tantalum	Kalrez	N2010250		N3160146
Plastic Body	Aqueous	Platinum/Iridium	Viton	N3150188	N0370392	N3150525
High-Sensitivity Plastic Body	Aqueous or Organic	Platinum/Iridium	Kalrez	B0505480	N0370392	B0501022
High-Sensitivity Plastic Body	Aqueous or Organic	Tantalum	Kalrez	B0505590	N0370392	
Stainless Steel Body	Aqueous	Stainless Steel	Viton	03030352	00570984	03030354
Corrosion Resistant Metal Body	Aqueous or Organic	Tantalum	Kalrez	03030404	00570984	03030402
Platinum Alloy Nebulizer	Aqueous	Platinum/Iridium	Kalrez	03030299	00570984	03030433
Universal GemTip	Aqueous	Plastic with Sapphire Tip	Viton	N0370394	N0370392	N0371520
High-Sensitivity GemTip	Aqueous or Organic	Plastic with Sapphire Tip	Kalrez	N0370393	N0370392	N0371522

Nebulizer Accessories

Description	Part No.
Capillary Tubing	09908265
Nebulizer Cleaning Wires Pkg. 5	03030135
Nebulizer Grease	03030405



Nebulizer Capillary Tubing



Nebulizer Cleaning Wires



Nebulizer Grease

Autosampler Cups and Supplies

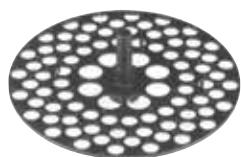

88-Position Tray

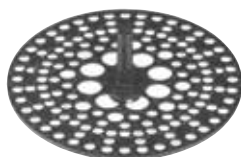

148-Position Tray

Furnace Autosampler Trays

For a quick change to another series of samples, a second sample tray is recommended.

For Model AS-800/AS-900

Description	Part No.
88-Position Tray, Polypropylene 80 sample locations for 2.0, 2.5 or 3.5 mL sample cups. Each sample tray also has 8 positions for 7.0 mL reagent containers	B3001507
148-Position Tray, Polypropylene 132 sample locations for 1.2 mL sample cups and eight locations for 2.5 or 3.5 mL sample cups. Each sample tray also has 8 positions for 7.0 mL reagent containers. One is provided with the autosampler	B3001506
Cover	B3001505
Pipette Arm	B3002046



Furnace Sampling Probe

Made of PTFE, these are capable of pipetting a variety of corrosive matrices and organic solutions.

Features and Benefits

- Works well with solvent and acid-resistant sampling components
- PTFE pipette tips and capillaries reduce contamination
- Easy replacement

Description	Part No.
For Models AS-60/AS-70/AS-71/AS-72/AS-800/AS-900	B0129258
Cutting Tool for Furnace Sampling Probe	B0510268

Reagent Containers

For blank solutions, reagent solutions or matrix modifiers.

Description	Part No.
Round Reagent Containers For Models AS-40/AS-60/AS-70/AS-71/AS-72. 25 mL polypropylene. Suitable for organic solutions	B0101164
30 mL Polystyrene – Not for organic solutions	B0102332
Cloverleaf-shaped Reagent Containers For Models AS-60/AS-70/AS-71/AS-72. 30 mL polypropylene	B0132799



Graphite Furnace Autosampler Cups

Sample cups are of heavy-duty construction to prevent cracking or tipping. Their conical design allows for use of nearly the entire sample.

Your Choice of Materials:

- **Polystyrene** – Clear, recommended for use with most aqueous solutions
- **Polyethylene** – Translucent, low-density, recommended for use with most aqueous solutions
- **PTFE** – Recommended for use with most concentrated acids including HF, and for analyses where the lowest detection levels are required
- **Polypropylene** – Translucent; preferred for most solvents

Volume	Composition	Qty.	Part No.
1.2 mL*	Polypropylene	2,000	B0510397
2.0 mL	Polyethylene	1,000	B0087056
2.0 mL	Polystyrene	1,000	B0119079
2.0 mL	PTFE	30	B0087600
2.5 mL	Polypropylene	1,000	B3001566
3.5 mL	Polystyrene	100	B0129303
7.0 mL**	Polypropylene	100	B3001567

* For use with AS-71/72/800/900 ** For use with AS-800/AS-900



Pliers and Accessories

Description	Part No.
For 1.2 mL sample cups.	B0510398
Drain Bottle without Cap 2 L	B0104344
Rinse Bottle	B0104281

Check Valves

Description	Aqueous Part No.	Organics Part No.
Check Valve Inlet	B3002007	B0105973
Check Valve Outlet	B3002006	B0105974
Inlet and Outlet Kit	B3001485	

Air Compressors

AA Ultra Quiet Oil-Less Air Compressor

PerkinElmer is expanding its compressor product portfolio to include an industrial grade, quiet, oil-less compressor for dependable and clean air supply. With the addition of a water separator with a 5 micron particle filter, no liquid transfers into the air supply, providing you with contaminant free air. Each quiet, vibration free compressor comes standard with an internally and externally coated air tank with automatic condensate drain system and collection bottle. The AA Ultra Quiet Oil-Less Air Compressor features a low operating sound level of 60 dB and comes completely outfitted to operate the PerkinElmer Atomic Absorption (AA) Spectrometers.

Features and Benefits

- Completely quiet oil-less operation
- Delivers clean and dry instrument grade air
- Water separator with 5 micron particle filter assures no liquid transfer
- Specialty coated cylinders and high temperature piston rings for long service life
- Durable air tank with automatic condensate drain, internal coating and 5 year warranty
- Low annual operating costs
- 2-year system warranty
- A complete compressed air station incorporating an outlet pressure regulator, tank and outlet pressure gauge, shut off ball valve, ASME safety valve, and pressure switch allowing for complete automatic operation



ISO 13485-2008
Certified



Specifications	
Horse Power	1 HP
Output CFM	4.2 CFM
Output L	120 L/min
Max Pressure PSI	120 PSI
Max Pressure Bar	8 bar
Max Current 110 V	7.8 Amps
Max Current 220 V	3.8 Amps
Noise Level	60 db/A
Tank Size Gallons	6
Tank Size L	24
Dimensions	16 in. x 16 in. x 21 in.
Weight	53.8 lbs.
Packed Dimensions	20 in. x 20 in. x 25 in.
Packed Weight	65.8 lbs.

Description	Part No.
Compressor 115V/60Hz	N9306345
Compressor 220V/50-60Hz	N9306346
Replacement Air Intake Filter	N0777870
Micron Dryer Filter Element	N0777871

THGA Graphite Tubes

THGA Graphite Tubes with Advanced Platform™

The exclusive and patented Advanced Platform design offers an alternative to our Standard Integrated Platform design. With the current Integrated Platform design, the platform attaches to the tube wall along a single side that runs the length of the platform. The new Advanced Platform design suspends the platform in the tube using three small pins in a triangular layout. This has the advantage of minimizing wall contact and reducing thermal conduction from the tube walls resulting in even and rapid heating almost exclusively from thermal radiation, an ideal platform.



Advanced Platform Features

- Even and rapid heating
- Improved sensitivity for some applications
- Improved batch to batch reliability
- Exclusive and patented design – only from PerkinElmer!

Description	Advanced Platform Part No.	Advanced Platform with End Caps Part No.
5-Pack	N9307830	N9307832
10-Pack NEW	N9304644	N9304645
20-Pack	N9307831	N9307833



Standard THGA Graphite Tubes

Today's analysts expect exceptional analytical performance from their graphite furnace atomic absorption spectrometers. That performance must be reproducible from day to day with respect to sensitivity (characteristic mass), accuracy and precision.



The graphite tube, the heart of the graphite furnace, plays a vital role in the overall stability of an analysis. In order to assure stable analytical conditions from one atomization cycle to the next and from graphite tube to graphite tube, all graphite parts – contacts, tubes and platforms – must be subject to strict quality control by both the instrument manufacturer and the graphite manufacturer.

PerkinElmer's unique, transversely-heated graphite tube includes an integrated platform. The exceptionally uniform temperature distribution obtained with transverse heating significantly reduces or eliminates condensation of the sample matrix components and 'memory' effects and improves the atomization efficiency for refractory elements.

Standard THGA Graphite Tubes with End Caps

For improved characteristic mass with volatile and medium refractory elements such as Ag, As, Cd, Co, Cr, Cu, Pb, Se and Tl, the THGA graphite tubes with end caps are recommended.

Note: THGA graphite tubes with end caps are not recommended for refractory elements such as V or Ba.



Features and Benefits

- Improved detection limits for volatile and medium refractory elements
- Faster drying for complex matrices due to enlarged dosing hole

Description	Standard THGA Part No.	Standard THGA with End Caps Part No.
5-Pack	B3000641	B3000653
10-Pack NEW	N9304642	N9304643
20-Pack	B0504033	B3000655
100-Pack	N3110147	

UltraClean THGA Graphite Tubes

For the lowest possible detection limits, residual contaminant levels may not be low enough to meet your requirements. For the most demanding analyses, PerkinElmer offers UltraClean THGA graphite tubes – delivering exceptionally low levels of contamination due to advanced high-temperature gas-phase cleaning procedures. UltraClean graphite tubes offer unmatched analytical advantages for special applications such as the determination of extremely low traces of Na, Ca, Fe, Cr and Ni in ultra-clean reagents used in the semiconductor industry, and ultra-trace analyses of environmental, clinical, or food samples.



Features and Benefits

- UltraClean THGA graphite tubes have the lowest possible contamination levels due to extensive high-temperature gas-phase cleaning procedures
- UltraClean THGA graphite tubes are tested and specified for blank levels of Cr, Ni, V, Mo, Ti (<0.003 integrated absorbance units) and Na, Fe, Al, Si, Ca (<0.0005 integrated absorbance units)

Description	Part No.
5-Pack	B3140361
20-Pack	B3140362

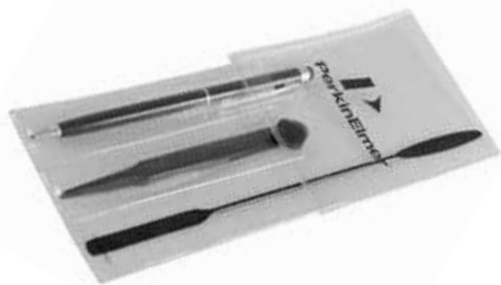

Three-Piece Sample Preparation Tool Kit

Stainless-Steel tools are coated with an inert carbon surface so they will not transfer trace metals to graphite tubes or the sample that is being handled. Tool kit comes with one straight tweezer, one spatula and a customized PerkinElmer pen.

Features and Benefits

- Metal-free handling of graphite and solid samples
- Coating leaves a non-porous surface on the tools that is easy to clean
- Coated tools have a temperature resistance up to 400°C

Description	Part No.
Three-Piece Sample Preparation Tool Kit	N9304648

THGA Contact Cylinders

These graphite contact cylinders are engineered for a precise fit so that variations in electrical contact – which might affect the analytical performance – are reduced to a minimum. Contact cylinders with a modified injection port area help to minimize condensation and improve analytical performance with difficult matrices.



Standard THGA Graphite Contact Cylinders

Description	Part No.
1 Pair	B0504035
5 Pairs	B0504036

Modified THGA Contact Cylinders

Description	Part No.
1 Pair	B3002103
5 Pairs	B3002102



Accessories and Spare Parts

Description	Part No.
O-Ring (behind Contact Cylinder, front and back)	B0500748
Contact Cylinder Removal Tools	B3120405
THGA Filter Cartridge AA600 Fume Extractor Qty. 50	B0509065
Spare Graphite Tip for Fume Extraction System	B0506722
Pliers	09907925
THGA Quartz Window	B0198005
THGA Quartz Window O-Ring	B0501236



THGA Instrument Mirror

Used to optimize drying temperatures and times.

Description	Part No.
THGA Instrument Mirror	B0851900

HGA Graphite Tubes

The production of high-quality graphite components requires stringent quality control. To ensure high quality and consistency, a specific grade of high-density base graphite material has been developed for PerkinElmer's exclusive use. This base graphite material is used for the manufacturing of all PerkinElmer graphite tubes.

Selection and careful control of raw materials are extremely important. The composition and the microstructure of the base graphite material determine the specific resistivity of the tube and its heating characteristics.

When you purchase graphite supplies from PerkinElmer, you get the results of our many years of experience with quality graphite parts.

The proper performance, maintenance and serviceability of our graphite furnace systems can be assured only through the use of genuine PerkinElmer graphite components.

Pyrocoated Advanced Platform Graphite Tubes

The exclusive and patented Advanced Platform design offers an alternative to our Standard Integrated Platform design. With the current Integrated Platform design, the platform attaches to the tube wall along a single side that runs the length of the platform. The new Advanced Platform design suspends the platform in the tube using three small pins in a triangular layout. This has the advantage of minimizing wall contact and reducing thermal conduction from the tube walls resulting in even and rapid heating almost exclusively from thermal radiation, an ideal platform.



Advanced Platform Features

- Even and rapid heating
- Improved sensitivity for some applications
- Improved batch to batch reliability
- Exclusive and patented design – only from PerkinElmer!

Graphite Tubes with Advanced Platform

Description	Part No.
5-Pack	N9307834
10-Pack NEW	N9304646
20-Pack	N9307835



Pyrocoated Graphite Tubes with Integrated Platforms

Proven in labs throughout the world, graphite tubes with integrated platforms provide superior performance and are easy to use. Graphite tubes with integrated platforms are machined from one piece of graphite and are totally pyrocoated, providing exceptional tube-to-tube reproducibility. The spherically-shaped platform accommodates up to 50 µL of sample.

Features and Benefits

- Provide STPF conditions for volatile and nonvolatile refractory elements due to the significantly higher heating rates of tube and platform, which can be used for all elements
- Offer an extra measure of convenience versus manually inserting a separate platform
- Provide longer life with many aggressive sample matrices, such as concentrated acids

Pyrocoated Graphite Tubes with Integrated Platforms

Description	Part No.
5-Pack	B3001262
10-Pack NEW	N9304647
20-Pack	B3001264
40-Pack	N9300651

Pyrocoated Graphite Tubes*

Description	Part No.
5-Pack	B0105197
10-Pack	B0135653
20-Pack	B3000342
20-Pack (Forked Platform)	B0505057
50-Pack	B0091504

*Not compatible with L'vov platforms.

Grooved Pyrocoated Graphite Tubes

Internally grooved to accept L'vov platforms. Does not include platform.

Description	Part No.
5-Pack	B0137111
10-Pack	B0121092
20-Pack	B3001254

L'vov Platforms

The L'vov platform is a small plate of solid pyrocoated graphite that is inserted into the graphite tube. It has a slight depression in the center, which can accommodate up to 50 µL of solution.



The function of the L'vov platform is to isolate the sample from the tube walls to allow more reproducible atomization of the sample through indirect heating. The platform heats primarily by the radiation given off from the tube walls. Sample vaporization and atomization occur after the tube reaches a steady-state temperature.

Use of the L'vov platform provides

- Vaporization into a higher temperature gas atmosphere producing more free atoms, which reduce interferences
- Longer tube life because aggressive samples are only in contact with the solid pyrolytic graphite platform

Description	Part No.
20-Pack	B3001256

Pyrocoated Graphite Tube with L'vov Platform

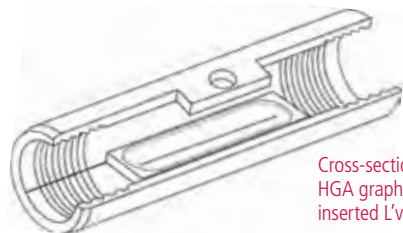

Cross-section of the PerkinElmer HGA graphite tube with manually inserted L'vov platform shown.

Pyrocoated Graphite Tube with Integrated Platforms

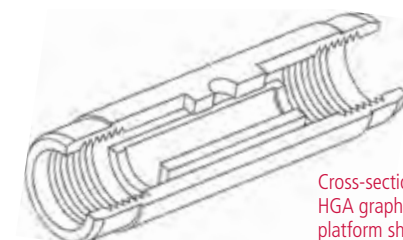

Cross-section of the PerkinElmer HGA graphite tube with integrated platform shown.

Contact Cylinders

The graphite contact cylinders used in the HGA Graphite Furnace are engineered for a precise fit so that variations in electrical contact – which might affect the analytical performance – are reduced to a minimum. The graphite contacts are shaped so that they completely encase the graphite tube. Thus, the graphite tube is located in a defined inert environment, which ensures uniform heating conditions and long tube lifetime.



Contact Cylinders

For HGA-900/850/800/700/600/300/PinAAcle H Furnaces. Includes left-hand Contact, right-hand Contact, Shield Ring.

Description	Part No.
1 Set	B0128495
5 Sets	B3130086

HGA Contact Removal Tool

Description	Part No.
HGA 900/AA 700/800/PinAAcle 900	B3121301

HGA Instrument Mirror

Used to optimize drying temperatures and times.



Description	Part No.
HGA Instrument Mirror	B0080259

Matrix Modifiers for Graphite Furnace AA



PerkinElmer provides you with the maximum performance and the lowest possible detection limits

with our high-quality matrix modifiers. PerkinElmer matrix modifiers thermally stabilize the analyte, allowing higher pyrolysis temperatures to be used, reducing background absorption and eliminating potential interferences.

Features and Benefits

- High-purity compounds minimize the risk of contamination
- Optimum graphite furnace program can be used due to reduced analyte volatility

Matrix Modifiers

Modifiers	Concentration	Volume	Part No.
Mg(NO ₃) ₂	1% Mg (as nitrate)	100 mL	B0190634
Pd	1% Pd (as nitrate)	50 mL	B0190635
NH ₄ H ₂ PO ₄	10% NH ₄ H ₂ PO ₄	100 mL	N9303445

AA Graphite for Non-PerkinElmer Instruments



PerkinElmer supplies a wide range of graphite tubes for non-PerkinElmer instrumentation. Graphite tubes are made with the highest quality material guaranteed to work for your AA instrument.

Use the convenient tables below to identify the compatible graphite furnace tube for your AA instrument.

GBC Instruments

Description	Qty./Pack	GBC Part No.	Part No.
Standard Tube, Pyrolytically Coated	10	99-0059-00	N9304600
Platform, Pyrolytically Coated	10	99-0060-00	N9304601
Standard Tube, Coated, with Omega-Platform	10	99-0342-00	N9304602
Electrode Contacts	2	99-0061-00	N9304603
Shroud	1	45-0004-00	N9304604

Hitachi® Instruments

Description	Qty./Pack	Hitachi Part No.	Part No.
Standard Tube, Pyrolytically Coated	10	180-7444	N9304605
Standard Tube, Uncoated	10	180-7400	N9304606
Standard Platform, Pyrolytically Coated	10	180-7404	N9304607
Tube for Extended Injection Volume, Pyrolytically Coated	10	190-6003	N9304608
Contacts, AD 20 mm	2	180-7401	N9304609
Zeeman Contacts, AD 18 mm	2	172-8805	N9304610
Omega Tube	10	N/A	N9304611

Shimadzu® Instruments

Description	Qty./Pack	Shimadzu Part No.	Part No.
Standard Tube, Pyrolytically Coated (90° contact cone)	10	206-50588	N9304612
Standard Tube, Uncoated (90° contact cone)	10	206-50587	N9304613
Tube with Built-In Platform, Coated (90° contact cone)	10	206-5887-02RI	N9304614
Left Electrode with Housing (90° cone)	1	206-50602	N9304615
Right Electrode (90° cone)	1	206-50603	N9304616

Thermo® Instruments

Description	Qty./Pack	Thermo Part No.	Part No.
Partridge Tube, Uncoated	10	9423 393 95031	N9304617
Partridge Tube, Coated	10	9423 393 95071	N9304618
Partridge Tube, Coated (extended lifetime)	10	9423 393 95041	N9304619
Zeeman Electrode Contact	2	9423 393 95161	N9304620
Standard Electrode Contact	2	9423 393 95011	N9304621
Omega Tube	10	9423 490 20101	N9304622

Agilent® Instruments

Description	Qty./Pack	Agilent Part No.	Part No.
Plateau Tube, Pyrolytically Coated	10	63-100011-00	N9304623
Bone Platform, Pyrolytically Coated (for use in plateau tubes)	10	63-100013-00	N9304624
Partition Tube, Pyrolytically Coated	10	63-100012-00	N9304625
Partition Tube, Uncoated	10	63-100015-00	N9304626
Partition Tube, Pyrolytically Coated Extended Life	10	63-100012-EL	N9304627
Omega-Platform Tube	10	63-100037-00	N9304628
Shroud	1	63-100018-00	N9304629
Electrode	2	63-100016-00	N9304630
Zeeman Shroud	1	63-100019-00	N9304631
Zeeman Electrode (Older Instruments)	2	63-100017-00	N9304632
Zeeman Electrode (Newer Instruments)	2	63-100035-00	N9304633
Zeeman Shroud GTA120, Pyrocoated	1	63-100036-00	N9304634

See Atomax 1.5 in. Hollow Cathode Lamps for non-PerkinElmer instruments on page 18.



Mercury Analyzer Supplies



PerkinElmer SMS 100 Mercury Analyzer

The SMS 100 is a dedicated mercury analyzer for the determination of total mercury in solid and liquid samples using the principle of thermal decomposition, amalgamation and atomic absorption described in U.S. EPA Method 7473.

The SMS 100 uses a decomposition furnace to release mercury vapor instead of the chemical reduction step used in traditional liquid-based analyzers. Both solid and liquid matrices can be loaded onto the instrument's autosampler and analyzed without acid digestion or sample preparation prior to analysis. Some of the many sample matrices applicable to SMS 100 technology include sludges, sediments, soils, wastewaters, effluents, coal, fly ash, minerals, ores, fertilizers, various foodstuffs, blood, urine and hair.



Amalgamator Tube



Catalyst Tube



Nickel Boat

SMS 100 Consumables and Supplies

Description	Part No.
Nickel Boats (Qty. 42)	N9309017
Quartz Combustion Boats (Qty. 10)	N9309032
Replacement Carbon 500 g	N9309035
Catalyst Tube (Packed)	N9309036
Autosampler Boat Shuttle	N9309019
Exhaust Tubing Assembly	N9309006
Amalgamator Tube	N9309007
Mercury Lamp	N9309010
Hg Vapor Trap Kit with Carbon Material	N9309011
Nafion® Drying Tube	N9309021
Sample Substrate 250 mL	N9309103
Oxygen Two Stage Regulator	N9309004
Oxygen, Nitrogen, Argon Supply	N9309009
UV Windows 1/2 in. d x 1/16 in. t 10-20 w (Qty. 2)	N9309024
O-Ring 1/16 in. ID x 1/16 in. w Viton	N9309025
O-Ring Amalgamator 1/4 in. ID, 3/8 in. OD Viton	N9309026
O-Ring Injector 5/8 in. ID, 3/4 in. OD	N9309027
O-Ring Catalyst Front Viton	N9309028
O-Ring .414D Catalyst Rear	N9309030
O-Ring Kit for SMS 100	N9309029
High Sensitivity Absorption Cell 5 in.	N9309033
Low Sensitivity Absorption Cell 1 in.	N9309034

Spares Kits

Description	Qty.	Part No.
Basic Spares Kit Kit Includes:		N9309109
Amalgamator Tube	1	N9309007
Mercury Source Lamp	1	N9309010
Nafion® Drying Tube	1	N9309021
O-Ring Kit	1	N9309029
Extended Spares Parts Kit Kit Includes:		N9309110
Amalgamator Tube	2	N9309007
Sample Gas Tubing Assembly	1	N9309008
Mercury Source Lamp	1	N9309010
Injector Fork Assembly	1	N9309012
CVAAS Tubing Kit	1	N9309013
Amalgamator Heater Coil	1	N9309066
6 g Krytox® Tube Grease	1	N9309020
Nafion® Drying Tube	1	N9309021
Quartz Windows	6	N9309024
O-Ring Kits	2	N9309029
Window End Caps	8	N9309031
5 in. Optical Cells	2	N9309033
1 in. Optical Cell	1	N9309034

Flow Injection System



FIMS



FIAS

The use of flow injection saves time, money and manpower – while at the same time, extending your analytical flexibility and capabilities.

PerkinElmer carries a wide selection of genuine supplies and accessories for your FIMS-100, FIMS-400, FIAS-100 or FIAS-400. Keeping your system in good working order by using only the best replacement parts is the first step in assuring quality analytical performance. Regular maintenance and/or replacement of consumables such as tubing, connectors and adapters will maximize the lifetime and productivity of your PerkinElmer flow injection system.

Adapters with Internal Thread

1/4 in. (6.4 mm) Internal Screw Thread

Type*	Description	Part No.
A B	A 1.8 mm OD Nipple	B0193342
	B 3.3 mm OD Nipple	B0506716
C	4 mm OD Nipple	B0196850
E	For the Quartz Cell	B0196857
F	0.7 mm OD Pt/Ir Capillary Nipple	B0193873
G	Two Nipples to Connect Tubes to the Pre-Concentration Accessory	B0501580

Connectors

Type*	Description	Part No.
IA	Connector with Nipples for 1.7 to 3.2 mm ID Tubes	B0199233
IB	Connector with Nipples for 2.4 to 3.2 mm ID Tubes	B0196882
II	Connector with 1/4 in. (6.4 mm) Internal Screw Thread	B0196704
IIIA	T-piece with Nipples for 1.5 to 2.5 mm ID Tubes	B0199035
IIIB	T-piece with Nipples for 3.5 to 4.5 mm ID Tubes	B0198201

Adapters with External Thread

1/4 in. (6.4 mm) External Screw Thread

Type*	Description	Part No.
K L	K 1.8 mm OD Nipple	B0507918
	L 2.8 mm OD Nipple	B0507920
M	4 mm OD Nipple	B0507919
N	0.7 mm OD Pt/Ir Capillary Nipple	B0507949
	Screw Plug	B0507921

*Type designation refers to diagrams in instrument manuals

FIAS/FIMS Cell Replacement Parts

Description	Part No.
Complete FIAS Cell and Windows	B0507486
FIAS Cell only (no windows)	B0507487
Quartz Window Assembly for FIAS and FIMS (one window)	B0066549
FIMS Complete Cell and Windows	B0510334
FIMS Cell Only (no windows)	B0510370
FIMS Hg Lamp	B3000243
FIMS Hg Filter Replacement for Hg Scrubber	B3000274

Mixing/Separation Assembly

Complete modular unit, consisting of two mixing manifolds with tubing adapters, a gas liquid separator with a PTFE membrane, five spare PTFE membranes, one PTFE tube (110 mm long) and one PTFE tube (300 mm long).

Description	Part No.
Mixing/Separation Assembly	B0507957

Mixing Block

Modular 'building block' type mixing manifold with one mixing channel and three connections, two inlet and one outlet. Made from chemically-resistant plastic. Several of these blocks can be 'plugged' together easily to create a single unit with enhanced mixing capabilities.



Description	Part No.
Mixing Block	B0507962

Gas/Liquid Separator

Modular 'building block' type gas-liquid separator made from chemically-resistant plastic. An exchangeable PTFE membrane in the screw cap of the separator prevents liquid from being carried into the quartz cell when working with strong foaming samples.



Description	Part No.
Gas/Liquid Separator	B0507959
Glass Gas/Liquid Separator	B0193772
Gas/Liquid Separator Holder for Glass Separator	B0509479
PTFE Membrane (Pkg. 50)	B0508306
Mixing Manifold for Glass Gas/Liquid Separator	B0187258
Plug Connector; Mixing Manifold to Gas/Liquid Separator	B0507960

Tool, Screw Connectors

Description	Part No.
Tool, Screw Connectors	B0501315

Flow Injection Furnace Supplies

Description	Part No.
FIAS-Furnace Sample Transfer Tube	B0509612
Quartz Pipette Tip/20 mm (Pkg. 1)	B0510032
Silicone Tube	B0029796

Sample Loops

Description	Part No.
200 µL	B0194048
500 µL	B0194049
1,000 µL	B0501000

Tubing

Standard PVC clear peristaltic pump tubing has a wall thickness of 0.84 mm.

Three-Stop Peristaltic Pump Tubing, Pkg. 12

Tubing ID	Colour Code	Part No.
0.76 mm	Black/Black	B0506058
1.14 mm	Red/Red	B0193160
1.52 mm	Yellow/Blue	B0193161
2.06 mm	Violet/Violet	B0199034
3.18 mm	Black/White	B0508310

Solvent Resistant Yellow Peristaltic Pump Tubing, Pkg. 12

Tubing ID	Colour Code	Part No.
1.02 mm	White/White	B0507692

PTFE Tubing

Tubing ID	Length	Part No.
0.35 mm	1 m	B0506060
0.5 mm	1 m	B0507020
0.7 mm	1 m	B0507021
1.0 mm	1 m	B0029792
1.75 mm	1 m	B0017998

PTFE Tubing Assemblies

Tubing ID	Screw Fittings Color	Length	Part No.
0.35 mm	White	60 mm	B0501594
1.0 mm	Blue	110 mm	B0191058
1.0 mm	Blue	300 mm	B0198097
1.0 mm	Blue	700 mm	B0191059
1.0 mm	Blue	1,000 mm	B0191060
1.75 mm	Black	250 mm	B0198099
1.75 mm	Black	450 mm	B0198100
3-Dimensional Reactor 0.35 mm (two flanged ends)			B0501595

PVC Tubing

Description	Part No.
3 mm ID with 1 mm Wall Thickness, No Fittings	B0048139

Price per meter

Silicone Tubing

Description	Part No.
1 m x 5 mm ID, No Fittings	B0018283
1 m x 3 mm ID	B0070126
For FIMS Cell Exhaust Outlet, 3 m	B0046948

Flow Injection Sampling Supplies

Pump Magazines

Description	Part No.
Magazine for Peristaltic Pump One wide (>2 mm) tubing channel	B0507792
Magazine for Peristaltic Pump Two narrow (<2 mm) tubing channels	B0507791
Pump Roller Assembly	B3000251

Alternate Reductant Kit

Permits use of the FIAS-100, FIAS-400 and FIAS-400MS with an alternate reductant (e.g., SnCl₂ instead of NaBH₄).

Description	Part No.
Alternate Reductant Kit	B0508594
Includes:	
Mixing/Separation Assembly	B0507957
700 mm Single Flanged PTFE Tubing	B0191059
PTFE Tubing (110 mm)	B0191058
Red/Red Pump Tubing (Pkg. 12)	B0193160
Adapter A	B0193342
PTFE Tubing (300 mm)	B0198097

FIAS Accessories Case

Includes the most frequently used FIAS supplies, including adapters, pump tubings, connectors, sample loops and PTFE tubings.

Description	Part No.
FIAS Accessories Case	B3000240

Flangeless Ferrule

For 1/16 in. tubing, Blue Tefzel®.

Description	Part No.
Flangeless Ferrule	09903799

Naflon® Single Tube Dryer

Continuously and highly selectively removes water from gaseous samples without affecting analytes. (Requires separate flow controller).

Description	Part No.
Naflon® Single Tube Dryer	N9306016



Switching Valves

Description	Part No.
FI Switching Valve*, 5-Port For on-line pre-concentration. Included with all FIAS systems	B0507914
FI Switching Valve*, 8-Port For FIAS-MS	B0509095
Push-Button Assembly For manual program actuation with the FIAS-100 and FIAS-400 Included with the FIAS-100	B0505650
Disassembly Tool Valve dismantling tool	B0509590
One-Way Valve	B0198111

* For FI valve repair or replacement parts, please contact your local PerkinElmer Service office.

Electrically Heated Mantle (Cell) Adapter Cables

Description	Part No.
Cable for Adapting New RoHS FIAS/FIMS System to a Non-RoHS Heating Mantle	N2010255
Cable for Adapting New RoHS Heating Mantle to a Non-RoHS FIAS/FIMS System	N2010262

Mercury/Hydride Systems and Supplies

MHS-15

Mercury/Hydride Systems are well proven accessories for high-sensitivity determinations of mercury and metallic hydride-forming elements, including As, Se, Sb, Te, Bi and Sn by atomic absorption spectroscopy.



- Complete separation of the element being studied from its sample matrix
- Simple, highly specific operating procedures
- Reliable pneumatic control of carrier gas and transport of metallic vapors to the quartz cell
- Conveniently stands adjacent to the sample compartment of the AA spectrometer

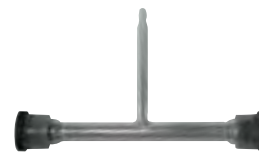

Quartz Cell for MHS-10/15
Part No. **B0094415**

Quartz Cells

Description	Part No.
Quartz Cell for MHS-10 and MHS-15 Complete with graphite cooling rings and silicone rubber sleeves	B0094415
Quartz Cell for MHS-20 With Windows	B0097693
Without Windows	B0097694
Quartz Window for MHS-20 Quartz Cells	B0098452
Universal Quartz Cell Holder To mount MHS-10 or MHS-15 quartz cell on burner system	B3000350

Supplies

Description	Part No.
Flashback Arrestor	B0098640
Graphite Cooling Ring for Quartz Cells*	B0094413
Immersion Tube (Pipette Tip)	B0094138
Reductant Reservoir (with cap)	B0087354
Reductant Reservoir (without cap)	B0094032
Sample Flask**	B0094321
Silicone Sleeve for Quartz Cells	B0098453
Transfer Hose	B0094140

* For MHS-10 and MHS-15 only. ** Specially formed polypropylene reaction vessel with cover.

MHS-15 Detection Limits

Element	Detection Limit* Absolute (ng) (in 10 mL volume)	Detection Limit* Relative (µg/L) (in 50 mL volume)
As	1.0	0.02
Se	1.0	0.02
Bi	2.0	0.10
Sb	5.0	0.10
Te	2.0	0.05
Hg	1.0	0.02

* EDL lamps were used for all elements

MHS-15 Mercury/Hydride System

Manually operated system for the high-sensitivity determination of Hg and hydride-forming elements. Includes analyzer with sample flask, reagent reservoir, quartz cell and cell holder. Switch allows selection of NaBH₄ or SnCl₂ reductant solution. No electrical connections are required.

Description	Part No.
MHS-15 Mercury/Hydride System	B3140760

Inductively Coupled Plasma-OES

PerkinElmer offers a wide selection of superior quality products designed to work with your PerkinElmer instruments. Our precision designed products deliver the peace of mind that comes from knowing that you'll get the results you need.

Quick Reference Index Page

▶ Concentric Nebulizers	42
▶ MicroFlow Nebulizers	45
▶ Nebulizers with Integrated Probes	46
▶ GemCone Nebulizers	47
▶ GemTip Nebulizers	47
▶ Nebulizer Cleaners	49
▶ Humidifiers	49
▶ Cyclonic Spray Chambers	50
▶ HF Resistant Spray Chambers	52
▶ PFA Spray Chambers	52
▶ Scott Spray Chambers	52
▶ Temperature Controlled Spray Chambers	53
▶ Sample Introduction Quick Change Modules	54
▶ Hydride Accessory Kit	57
▶ Torches	58
▶ Load Coils and Purge Components	61
▶ Injectors	62
▶ Air Compressors	64
▶ FAST High Productivity Systems	65
▶ prepFAST Autodilution and Autocalibration Systems	65

▶ CLICK THE ARROWS TO VIEW EACH PAGE

Concentric Nebulizers

PerkinElmer offers a complete selection of Nebulizers in a variety of materials for all of your application needs.

Choose from Concentric, MicroFlow, GemCone and GemTip Nebulizers.



▶ VIEW PAGE

Humidifiers

Argon Humidifiers are commonly used in ICP analyses involving samples with high concentrations of dissolved solids. It helps to alleviate salt deposits in the nebulizer and torch injector, allowing uninterrupted and maintenance-free operation.



▶ VIEW PAGE

Spray Chambers

The spray chamber is an integral part of the sample introduction System. Each type of spray chamber has been tested to provide the best performance and analytical results.

Choose from Cyclonic, Baffled Cyclonic, HF Resistant, PFA and Scott Spray Chambers.



▶ VIEW PAGE

Torches

PerkinElmer carefully selects the best materials which provide optimal performance. Torches are specifically designed for your instrument. Trust the consumables engineered for your instruments.

Choose from Demountable Quartz, D-Torch and Ceramic Hybrid Torches.



▶ VIEW PAGE

Injectors

PerkinElmer offers a complete selection of Injectors in various sizes and materials to meet all of your application needs.

Choose from Alumina, Sapphire and Quartz Injectors.



▶ VIEW PAGE

▶ TABLE OF CONTENTS

▶ ORDER ONLINE



**EXPAND
YOUR RANGE**
EXTEND YOUR RESOURCES



Avio 500 ICP-OES

The Avio 500 ICP-OES - High throughput with low cost of ownership

The Avio® 500 ICP-OES combines the productivity you need with the high-quality performance and faster return on investment your work demands. With high sensitivity and superior resolution, your lab can accomplish more, even when dealing with the most difficult samples. And with the lowest argon consumption of any ICP, simultaneous background correction, and high throughput enabled by Dual View technology, it all comes together to expand the range of what you can accomplish. High throughput. Low cost of ownership. Superior performance. It's everything you want in an ICP-OES system.

For more information, visit perkinelmer.com/avio500

Concentric Nebulizers



MEINHARD® Nebulizers

The MEINHARD® concentric nebulizers reflect exacting standards in design and manufacturing. They provide excellent sensitivity and precision for aqueous solutions and samples with few dissolved solids (less than 1%).

MEINHARD® Glass Nebulizers

Type A nebulizers are for high sensitivity. Type C and K are for high solids. Type K are for low argon flow.

Type	Ar Flow Rate	Uptake Rate	Material	Part No.
Optima 4x00/5x00/7x00/8x00 / Avio 200/500				
A3	1 L/min	3 mL/min	Glass	00472020
C1	1 L/min	1 mL/min	Glass	00472022
K3	0.7 L/min	3 mL/min	Glass	N0681574
K1*	0.7 L/min	1 mL/min	Glass	N0777707
K1 LDV	0.7 L/min	1 mL/min	Glass	N0811287

Includes: **N0777414, N8121036, N0777460** *Standard with Avio instrument

MEINHARD® Plus Nebulizers

Type A+ nebulizers are for low dead volume and high sensitivity

- Self aspiration rate 0.5 mL/min with argon flow 1 L/min at 50 PSI (3.4 bar/345 kPa)
- Peristaltic pumped rate 0.1 mL/min to 3.0 mL/min
- *Quartz reduces blank levels compared to glass nebulizers

Type	Ar Flow Rate	Uptake Rate	Material	Part No.
Optima 4x00/5x00/7x00/8x00 / Avio 200/500				
TR+	1 L/min	0.5 mL/min	Glass	N8122462
TQP+	1 L/min	0.5 mL/min	Quartz*	N8122461

Includes: **N8121039, GL54, N8121036, N0777460**



MEINHARD® SilQ Nebulizers

Type A SilQ+ nebulizers are for ultra-high purity.

- Lowest levels of trace elemental impurities
- Reduced sample contamination
- *Quartz reduces blank levels compared to glass nebulizers

Type	Ar Flow Rate	Uptake Rate	Material	Part No.
Optima 4x00/5x00/7x00/8x00 / Avio 200/500				
SILQ+	1 L/min	0.5 mL/min	*Quartz	N8122460

Includes: **N8121039, GL54, N8121036, N0777460**



Nebulizer Solution Fitting
Part No. **N0777414**



Nebulizer Clip
Part No. **N0777460**



PFA Gas Quick Connect
Part No. **N8121036**



Part No. **N8121038**



Part No. **N8121037**



Part No. **N8121039**

MEINHARD® Nebulizer Replacement Parts

Description	Part No.
F5-50 Standard Nebulizer Solution Fitting, 0.5 mm PTFE. 0.5 mm x 70 cm Capillary	N0777414
F5-50-026-ZZ Liquid-End Connector Kit, 10 in. Length by 0.020 in. ID x 0.062 in. OD	N0811288
Nebulizer Clip for MEINHARD Nebulizers, Qty. 1	N0777460
FG PFA Gas Quick Connect	N8121036
F0 Encapsulated Micro Tubing, 0.25 mm ID (Green Marker) 70 cm Long Micro Capillary	N8121038
F1 Detachable Capillary, 0.80 mm ID (Blue Marker) 70 cm Long Capillary	N8121037
F2 Standard Integrated Capillary, 0.5 mm ID (Orange Marker) 70 cm Long Capillary	N8121039
MEINHARD Nebulizer Gas Line	N0791843
PFA Adapter for Glass Nebulizers	N8145365
Quick Disconnect Tubing without Swagelock	N0770610
Nebulizer Spacer (Avio)	N0791438



Part No. **N8145461**

FAST Valve Connecting Lines for MEINHARD® Plus Nebulizers

Description	Part No.
F0 FAST Valve Connecting Line, 0.25 mm ID (Green), 14 cm	N8145461
F2 FAST Valve Connecting Line, 0.25 mm ID (Green), 14 cm	N8145346
F0 FAST Valve Connecting Line, 0.5 mm ID (Orange), 14 cm	N8145462
F2 FAST Valve Connecting Line, 0.5 mm ID (Orange), 14 cm	N8145347
F0 FAST Valve Connecting Line, 0.25 mm ID (Green), 25 cm	N8145463
F2 FAST Valve Connecting Line, 0.25 mm ID (Green), 25 cm	N8145465
F0 FAST Valve Connecting Line, 0.5 mm ID (Orange), 25 cm	N8145464
F2 FAST Valve Connecting Line, 0.5 mm ID (Orange), 25 cm	N8145466

Direct Connection (DC) Nebulizers

The DC (Direct Connection) nebulizer is the latest design. It has a UniFit sample connector which slides easily over the sample arm and an argon connector configured to connect directly to your ICP. Includes Gas Fitting with ratchet connector (**N0811308**).



MicroMist DC Nebulizers

Ar Flow Rate	Uptake Rate	Part No.
Optima 4x00/5x00/7x00/8x00 / Avio 200/500		
0.7 L/min	0.05 mL/min	N0811303
0.7 L/min	0.1 mL/min	N0811302
0.7 L/min	0.2 mL/min	N0811301
0.7 L/min	0.6 mL/min	N0811300

SeaSpray DC Nebulizers

Ar Flow Rate	Uptake Rate	Part No.
Optima 4x00/5x00/7x00/8x00 / Avio 200/500		
0.7 L/min	0.4 mL/min	N0811307
0.7 L/min	1 mL/min	N0811306
0.7 L/min	2 mL/min	N0811305

VeeSpray DC Nebulizers

Ar Flow Rate	Uptake Rate	Part No.
Optima 4x00/5x00/7x00/8x00 / Avio 200/500		
0.7 L/min	4 mL/min	N0811289

DuraMist DC Nebulizers

Ar Flow Rate	Uptake Rate	Part No.
Optima 4x00/5x00/7x00/8x00 / Avio 200/500		
0.7 L/min	1 mL/min	N0811291
0.7 L/min	0.4 mL/min	N0811292

OpalMist DC Nebulizers

Ar Flow Rate	Uptake Rate	Part No.
Optima 4x00/5x00/7x00/8x00 / Avio 200/500		
0.7 L/min	2 mL/min	N0811293
0.7 L/min	0.6 mL/min	N0811294

Conikal DC Nebulizers

Ar Flow Rate	Uptake Rate	Part No.
Optima 4x00/5x00/7x00/8x00 / Avio 200/500		
0.7 L/min	2 mL/min	N0811298
0.7 L/min	1 mL/min	N0811299

SeaSpray™ Nebulizers

The SeaSpray concentric nebulizer is ideal for samples with high dissolved solids and offers outstanding nebulization efficiency for trace level analyses. Includes UniFit Connector with 0.75 mm ID x 1.3 mm OD x 700 mm long tubing (**N0777512**) and EzyLok Connector Kit (**N0777413**).



Ar Flow Rate	Uptake Rate	Material	Part No.
Optima 4x00/5x00/7x00/8x00 / Avio 200/500			
0.7 L/min	2 mL/min	Glass	N0775345

MicroMist™ Nebulizers

The MicroMist micro-uptake glass concentric nebulizer offers high performance for limited sample volumes. MicroMists with sample uptakes 0.2–0.6 mL/min are fitted with a UniFit connector with 1.3 mm OD x 0.50 mm ID x 700 mm long sample tubing (**N0777513**). MicroMists with sample uptakes 0.05–0.1 mL/min are fitted a UniFit connector with 1.3 mm OD x 0.25 mm ID x 700 mm long sample tubing (**N0777514**). EzyLok Connector Kit (**N0777413**) included.

Ar Flow Rate	Uptake Rate	Material	Part No.
Optima 4x00/5x00/7x00/8x00 / Avio 200/500			
0.7 L/min	0.05 mL/min	Glass	N0775349
0.7 L/min	0.1 mL/min	Glass	N0775348
0.7 L/min	0.2 mL/min	Glass	N0775347
0.7 L/min	0.6 mL/min	Glass	N0775346



UniFit Connector



EzyFit Connector



EzyLok Kit



Direct Connection Nebulizer Gas Fitting

SeaSpray and MicroMist Nebulizer Replacement Parts

Description	Pkg.	Part No.
UniFit		
0.25 mm ID x 1.3 mm OD x 700 mm	10	N0777514
0.50 mm ID x 1.3 mm OD x 700 mm	10	N0777513
0.75 mm ID x 1.3 mm OD x 700 mm	10	N0777512
1.30 mm OD x 0.75 mm ID x 700 mm	3	N0774077
1/16 in. OD x 0.25 mm ID x 700 mm	10	N0777845
1/16 in. OD x 0.50 mm ID x 700 mm	10	N0777846
1/16 in. OD x 0.75 mm ID x 700 mm	10	N0777847
1/16 in. OD x 0.75 mm ID x 700 mm	3	N0774080
UniFit-EzyFit Sample Tube	6	N0777061
EzyFit		
0.25 mm ID x 1.27 mm OD x 700 mm	10	N0777437
0.50 mm ID x 1.27 mm OD x 700 mm	10	N0777436
0.75 mm ID x 1.27 mm OD x 700 mm	10	N0777435
0.25 mm ID x 1/16 in. OD x 700 mm	10	N0777464
0.50 mm ID x 1/16 in. OD x 700 mm	10	N0777463
0.50 mm ID x 1/16 in. OD x 700 mm Twin	6	N0777462
UniFit-EzyFit Sample Tube	6	N0777061
EzyLok Kit		
EzyLok Kit Includes: EzyLok Connector for 4 mm Tubing, EzyLok 6 mm Hose Adaptor, Nebulizer Hose Clip		N0777413
Nebulizer Pressure Hose Clips (standard)		N0773197
Direct Connection Nebulizer Gas Fitting		
DC Nebulizer Gas Fitting with Ratchet Nebulizer Connector for Avio		N0811308

Conikal™ Nebulizer

Ideal for samples containing only moderate concentrations of dissolved salts, no particulates and no hydrofluoric acid. Includes UniFit Connector with 0.75 mm ID x 1.3 mm OD x 700 mm long tubing (**N0777512**) and EzyLok Connector Kit (**N0777413**).

Ar Flow Rate	Uptake Rate	Material	Part No.
Optima 4x00/5x00/7x00/8x00 / Avio 200/500			
0.7 L/min	2 mL/min	Glass	N0777487

Slurry™ Nebulizer

Ideal for the analysis of used engine oils for wear metals. A sample which consists of small particulates in liquid matrix is a slurry and is suited to this nebulizer. Includes UniFit Connector with 0.75 mm ID x 1.3 mm OD x 700 mm long tubing (**N0777512**) and EzyLok Connector Kit (**N0777413**).

Ar Flow Rate	Uptake Rate	Material	Part No.
Optima 4x00/5x00/7x00/8x00 / Avio 200/500			
0.7 L/min	4 mL/min	Glass	N0777488
0.7 L/min	4 mL/min (DC Nebulizer)	Glass	N0811304

VeeSpray™ Nebulizer

The VeeSpray nebulizer is made from alumina ceramic, making it ideal for HF analyses. It provides reproducible performance when working with samples containing large particulates.



Ar Flow Rate	Uptake Rate	Material	Part No.
Optima 4x00/5x00/7x00/8x00 / Avio 200/500			
0.7 L/min	0.6-3.0 mL/min	Alumina Ceramic	N0777489

DuraMist™ Nebulizer

The DuraMist is an economical nebulizer for high precision analyses involving samples digested in HF. Recommended for samples containing up to 5% HF.



Ar Flow Rate	Uptake Rate	Material	Part No.
Optima 4x00/5x00/7x00/8x00 / Avio 200/500			
0.7 L/min	0.4 mL/min	PEEK	N0777713
0.7 L/min	1.0 mL/min	PEEK	N0777714

OpalMist™ Nebulizer

For high precision analyses requiring the highest chemical resistancy of HF, alkalis and organics. The OpalMist is capable of aspirating high concentrations of dissolved solids without clogging. An ideal nebulizer to handle geochemical samples which are typically dissolved in HF and are high in dissolved solids.



Ar Flow Rate	Uptake Rate	Material	Part No.
Optima 4x00/5x00/7x00/8x00 / Avio 200/500			
0.7 L/min	0.6 mL/min	PFA	N0777735
0.7 L/min	0.05 mL/min	PFA	N0777738
0.7 L/min	0.1 mL/min	PFA	N0777737
0.7 L/min	0.2 mL/min	PFA	N0777736
0.7 L/min	2 mL/min	PFA	N0777734

Mira Mist® and Ari Mist Nebulizers

The PEEK Mira Mist handles most liquids, most flow ranges used in ICP and is one of the most rugged and longest life nebulizers due to its outer body being strong PEEK material. The Ari Mist has a very low sample flow, enhanced parallel path design. Standard pressure (40-50 psi). Black PEEK body, PTFE sample and gas capillaries. Can operate on 0.050 mL/min to 1.0 mL/min. Only for samples that are particulate free.



Description	Uptake Rate	Part No.
Optima 4x00/5x00/7x00/8x00 / Avio 200/500		
PEEK Mira Mist Excellent mist and can handle high level of particulates in sample	0.2 to 2.5 mL/min	N0775330
PTFE Mira Mist For samples with high HF, Sulfuric and some other solvents that attack PEEK	0.2 to 2.5 mL/min	N0777031
PEEK Ari Mist Very low sample flow, enhanced parallel path design	0.050 to 1.0 mL/min	N0777032

Mira Mist® and Ari Mist Nebulizer Replacement Parts

Description	Pkg.	Part No.
0.5 m, 0.44 in. OD x .018 in. ID	1	N0777111
0.5 m, 0.44 in. OD x .018 in. ID	10	N0777112
2 mm Gas Line with Upchurch Fittings	1	N0777113
Mira Mist Quick Release	1	N0777114
1/4 in. Adapter	1	N0777115
0.44 in. OD x .018 in. ID Polyethylene Tubing 3 m	1	N0777116
0.44 in. OD x .018 in. ID Polyethylene Tubing 30 m	1	N0777117

High Efficiency MicroFlow Nebulizers

MicroFlow nebulizers are resistant to clogging, reliably self-aspirated or pumped to produce a fine aerosol for high transport efficiency and high sensitivity.

PFA-ST Nebulizers

The PFA-ST MicroFlow nebulizer is made from high purity, HF resistant PFA. It has an exchangeable external sample uptake capillary. The sample uptake rate is controlled by the diameter of the external capillary or probe.



Features and Benefits

- Chemically resistant – ideal for strong acids, alkalis and organics
- Can be pumped from < 0.1 mL/min to 3.0 mL/min
- Direct analysis of volatile and non-volatile organic solvents
- Resistant to clogging – reliably self-aspirated or pumped
- Low, spike free background for important elements such as Fe and Ca

Description	Part No.
PFA-ST Nebulizer	N0777049
PFA-ST Self-Aspirating Nebulizer for prepFAST Systems	N8145368

PolyPro-ST Nebulizer

The PolyPro-ST Nebulizer is an HF resistant alternative to the PFA nebulizers but has the same high efficiency aerosol generation.



It is a robust nebulizer that can self aspirate with an exchangeable external sample uptake capillary or be used with a peristaltic pump.

Features and Benefits

- Polypropylene construction
- Hydrofluoric acid resistant
- 0-3 mL/min sample flow rate with peristaltic pumping
- Resistant to clogging and accidental breakage

Description	Part No.
PolyPro-ST Nebulizer	N0777219

PFA-ST3 Nebulizer

The PFA-ST3 Nebulizer is designated for superior clog resistance and higher sensitivity compared to the standard PFA nebulizer. The PFA MicroFlow is a high solids large bore nebulizer with external 1/4-28 threaded connector. Ideal for strong acids, high solids, alkalis, organic solvents, soils and high salt solutions.



Features and Benefits

- Produces a fine aerosol for high transport efficiency and high sensitivity
- Low BECs even for concentrated high purity acids (e.g. 49% HF, 69% HNO₃)
- Direct analysis of volatile and non-volatile organic solvents
- Ideal for VPD samples, high purity peroxide and ammonia

Description	Part No.
PFA-ST3 Nebulizer	N0777676

apex PFA Nebulizers

apex PFA nebulizers allow self-aspiration at low sample consumption rates with the apex high-sensitivity desolvation system.



Description	Part No.
High Temperature apex-ST PFA MicroFlow Nebulizer with External 1/4-28 Threaded Connector	N0777375
High Temperature apex-100 PFA Nebulizer with Integrated 90-150 µL/min Self-Aspiration Capillary	N0777376
High Temperature apex-100 PFA Nebulizer with Ultem Manual Sampling Probe, 90-150 µL/min, 80 cm Capillary	N077828

Sample Capillaries for ST Nebulizers



ID	Self-aspiration rate ID (@1 L/m Ar)	Part No.
0.15 mm	20 µL/min (Red)	N8122382
0.2 mm	50 µL/min (Purple)	N8145135
0.25 mm	100 µL/min (Green)	N8122383
0.3 mm	200 µL/min (Yellow)	N8145136
0.5 mm	400 µL/min (Orange)	N8122384
0.8 mm	700 µL/min (Blue)	N8145137
1.0 mm	1 mL/min (Gray)	N8145138

Nebulizers with Integrated Probes

These nebulizers self-aspirate at low flow rates with any autosampler and provide the same benefits of the PFA MicroFlow nebulizer. The integrated sampling probe is constructed by encapsulating a rigid support material between layers of PFA to provide a chemically-resistant probe that is mechanically stable and resilient.

PFA MicroFlow Nebulizers with Integrated Autosampler Probes

For environmental/clinical applications. These nebulizers self-aspirate at low flow rates with any autosampler and provide the same benefits of the PFA MicroFlow nebulizer. The integrated sampling probe is constructed by encapsulating a rigid support material between layers of PFA to provide a chemically-resistant probe that is mechanically stable and resilient.



Carbon Fiber support for Environmental/Clinical Applications.

Description	Aspiration Rate @ 1 L/m Ar	Part No.
PFA-20 PFA (Carbon Fiber Support), Length 80 cm	20 µL/min	N0777214
PFA-50 PFA (Carbon Fiber Support), Length 80 cm	50 µL/min	N0777215
PFA-100 PFA (Carbon Fiber Support), Length 100 cm	100 µL/min	N0777216
PFA-200 PFA (Carbon Fiber Support), Length 100 cm	200 µL/min	N0777217
PFA-400 PFA (Carbon Fiber Support), Length 100 cm	400 µL/min	N0777218

Ultem support for High Purity Semiconductor Applications.

Description	Aspiration Rate @ 1 L/m Ar	Part No.
PFA-20 PFA (Ultem Support), Length 100 cm	20 µL/min	N8145141
PFA-50 PFA (Ultem Support), Length 100 cm	50 µL/min	N8145142
PFA-100 PFA (Ultem Support), Length 100 cm	100 µL/min	N8145143
PFA-200 PFA (Ultem Support), Length 100 cm	200 µL/min	N8145144
PFA-400 PFA (Ultem Support), Length 100 cm	400 µL/min	N8145275

PFA Nebulizers with Integrated Fluoropolymer Capillaries

Self-aspirating PFA MicroFlow nebulizers are constructed entirely from chemically resistant fluoropolymers ideal for strong acids, alkalis, organics and high-salt solutions. They are resistant to clogging and produce a fine aerosol for high transport efficiency and high sensitivity.



- Integrated capillary for self-aspiration, ideal for low flow, clean applications
- Low, spike-free background for important elements such as Fe and Ca
- Produces a fine aerosol for high transport efficiency and high sensitivity
- Direct analysis of volatile and non-volatile organic solvents

Description	Aspiration Rate @ 1 L/m Ar	Part No.
PFA-20	20 µL/min	N8122350
PFA-50	50 µL/min	N8145102
PFA-100	100 µL/min	N8122351
PFA-200	200 µL/min	N8145103
PFA-400	400 µL/min	N8145104

Carbon Fiber Probes for ST Nebulizers

ST nebulizer probes connect directly to any ST-type nebulizer. The 1/4-28 threaded fitting provides a secure, zero-dead-volume connection with no additional fittings required.



ID	Aspiration Rate @ 1 L/m Ar	Length	Part No.
0.25 mm	100 µL/min	80 cm	N0777223
0.50 mm	400 µL/min	80 cm	N0777225
0.25 mm	100 µL/min	150 cm	N0777826
0.50 mm	100 µL/min	150 cm	N0777827
S10 Autosampler Probe for ST Nebulizers, 0.25 mm	100 µL/min	100 cm	N8145139
S10 Autosampler Probe for ST Nebulizers, 0.50 mm	400 µL/min	100 cm	N8145140

GemCone and GemTip Nebulizers

GemCone™ Low-Flow Nebulizer

Low-flow GemCones permit lower nebulizer gas flow rates, useful for spectral lines with high excitation energies and for providing a more robust plasma. GemCone Nebulizers require an end cap for use with Scott Spray Chambers.



Description	Part No.
GemCone Low-Flow Nebulizer	N0770358

GemCone High Dissolved Solids Nebulizer

High solids GemCones are for samples with high dissolved solids (up to 20%). This conespray nebulizer allows you to analyze samples with higher solids concentration than is possible with a Cross-Flow nebulizer. GemCone nebulizers require an end cap (Part No. **N0680343**) for use with Scott Spray Chambers.



Description	Part No.
GemCone High Dissolved Solids Nebulizer	N0690670
GemCone High Dissolved Solids Nebulizer with Quick Disconnect Tubing (N0770336)	N0770720



GemCone Nebulizer Replacement Parts

Description	Part No.
GemCone Sample Capillary Adapter	N0371505
Scott Spray Chamber End Cap for GemCone Nebulizers	N0680504
Quick Disconnect Tubing with Swagelok	N0770336
Quick Disconnect Tubing without Swagelok	N0770610
Capillary Tubing (10 ft.)	09908265
PTFE Capillary Tubing (1 ft.)	09985708

Argon Flow Rates

Nebulizer	Typical Value	Operating Range
GemTip Cross-Flow	0.6 L/min	0.4-1.3 L/min
Low-Flow GemCone	0.6 L/min	0.4-0.95 L/min
High Flow GemCone	1.0 L/min	0.7-1.0 L/min



GemTip Cross-Flow II Nebulizers

Excellent general purpose nebulizer for the analysis of strong mineral acids (including HF) and samples with less than 5% dissolved solids. It can routinely handle 50% (v/v) solutions of HCl, HNO₃, H₂SO₄, H₂PO₄, 20% (v/v) HF and 30% (v/v) NaOH. Up to 20% NaCl can be aspirated by the nebulizer for 1 hour without clogging. Uses chemically resistant GemTips made of sapphire and ruby in a chemically resistant end cap.

ICP Model	Part No.
Optima 8x00 / Avio 200/500	N0780546
Optima 2x00/4x00/5x00/7x00	N0770546

GemTip Nebulizer O-Ring Kit

Description	Part No.
GemTip™ Cross-Flow Nebulizer O-Ring Kit Includes: 09902001 Qty. 2, 09902033 Qty. 2, 09902151 Qty. 3, 09921003 Qty. 1, 3 cm of PTFE Sample Tubing	N9300067



GemTip Cross-Flow II Nebulizer Tip Kits

The Tip Kit includes a clear sapphire sample tip and a red ruby argon tip. The tips are constructed of PEEK with the gem inserts noted for maximum corrosion resistance.

ICP Model	Part No.
Optima 8x00 / Avio 200/500	N0780676
Optima 2x00/4x00/5x00/7x00	N0690676

See next page for GemTip Cross-Flow II Nebulizer Replacement Parts

GemTip Cross-Flow II Nebulizer Replacement Parts

Description	Part No.
1 Screws (two) – Knurled	00473539
2 Ring	00473543
3 O-Ring, 18W, 1-3/8 ID, 1-5/8 OD	09902033
4 Fitting Reducer 1/8 TBG, 1/4 Port	09903471
* These parts are included with item 4	
5 Ferrule – TBG 1/8 Tefzel	09920515
6 Nut – TBG Flanged 0.0625 PEEK	09920546
7 Nut – TBG Flanged 0.125 PEEK	09920545
8 Ferrule – TBG 1/16 Tefzel	09920518
9 Tubing, 0.032 ID x 0.016 Wall, PTFE (per foot)	09985708
10 Tubing, 0.06 ID x 1/8 OD, PTFE (per foot)	02506483
11 Tip Kit for Cross-Flow Nebulizer Argon and Sample tip (one each)	N0690676
a Argon Tip (Red)	
b Sample Tip (Clear)	
12 End Cap Cross-Flow Nebulizer	N8122239
13 O-Rings (two) 0.126 ID, 0.040 WD, Viton	09921045
14 Tubing (10 ft.) – 0.023 ID, Clear	09908265
15 Nut – Hex – 0.250 TBG BRS	09903199
16 Ferrule – Back 1/4 BRS	09903104
17 Ferrule – Front 1/4 BRS	09903103
18 Insert – Tubing	00473578
Barbed coupler – Not Shown	09920186

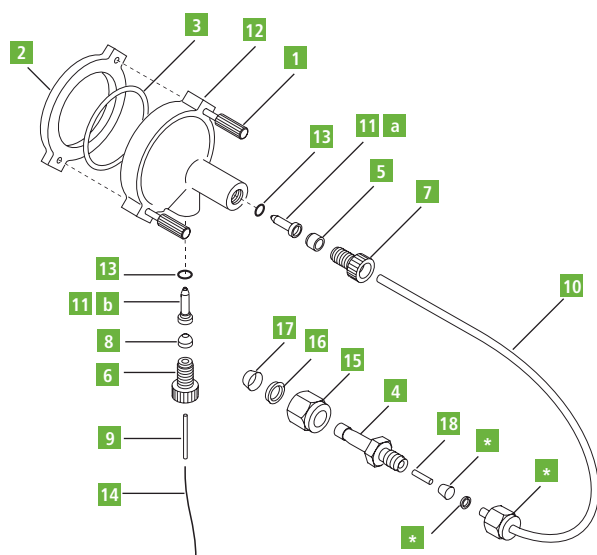

Online Mixing Kits

The mixing kit for online addition of internal standard is an easy way to use internal standards without having to manually spike each sample with internal standard. The kit can also be used to mix any two reagents for other purposes. The low dead-volume, fluoropolymer mixing tee ensures good mixing at typical flow rates for a wide variety of liquids, including HF.



Includes:

- Low dead-volume, fluoropolymer mixing tee
- 0.25 mm ID (green) for flow rates < 1 mL/min
- 0.5 mm ID (orange) for flow rates > 0.3 mL/min
- Internal standard probe and addition line
- Fluoropolymer peripump fittings
- Peristaltic pump tubing starter pack

Online Dilution:

The online mixing kits include a starter pack of peristaltic pump tubing for the MP² micro peristaltic pump.

Description	Part No.
Online Mixing Kit For use with PFA-ST nebulizers. 0.25 mm ID (Green)	N8145358
Online Mixing Kit For use with MEINHARD Plus nebulizers. 0.25 mm ID (Green)	N8145360
Online Mixing Kit For use with PFA-ST nebulizers. 0.5 mm ID (Orange)	N8145359
Online Mixing Kit For use with MEINHARD Plus nebulizers. 0.5 mm ID (Orange)	N8145361
Online Mixing Kit For use with MiraMist and similar nebulizers. 0.5 mm ID (Orange)	N8145362
Online Mixing Kit For use with PFA-ST nebulizers. Includes PFA-ST nebulizer. 0.25 mm ID (Green)	N8145363
Online Mixing Kit For use with MEINHARD Plus nebulizers. Includes TR+ high sensitivity glass nebulizer. 0.5 mm ID (Orange)	N8145364

Part No. **N8145365**



Description	Part No.
PFA Adapter for Glass Nebulizers Allows MEINHARD Plus mixing kit to be used with other types of glass nebulizers	N8145365

Nebulizer Cleaners

The Eluo™ Nebulizer Cleaner



The Eluo is designed to efficiently deliver a cleanser through the nebulizer capillary to dislodge particle build-up and thoroughly clean the nebulizer. One simple action does it all. No more messy procedures, waiting overnight or shattered nebulizers in ultrasonic baths.

Description	Part No.
For Newer OpalMist, PolyCon, DuraMist, MEINHARD, Other Glass Nebulizers	N077712
For OLD Style OpalMist or PolyCon Nebulizers	N0775358

Pearl Nebulizer Cleaner



With the Pearl, a cleaning solution can be pumped manually in reverse, through both the sample and gas passages. When the wet-cleaning process is finished, rinse with DI water and flush dry with compressed air or inert gas.

Description	Part No.
For Glass and Quartz Concentric Nebulizers	N8145457

Syringe Flush Kit



Use syringe and white adapter to back-flush the carrier line or tee-line. Use syringe and red adapter to forward flush the carrier line, the side port of the tee-line and to forward flush the PFA nebulizer. Includes 3 mL syringe, two luer to 1/4-28 adapters.

Description	Part No.
Syringe Flush Kit	N8121035

Fused Silica Obstruction Removal Kit



Fused silica obstruction removal kit for ST-type nebulizers. Includes one guide, 10 pieces of fused silica and instructions. Use this kit to safely remove obstructions in all PFA-ST nebulizers for long-term high performance.

Description	Part No.
Nebulizer Obstruction Removal Kit	N8145236

Humidifiers

Capricorn Argon Humidifier with Bypass

The Argon Humidifier is commonly used in ICP analyses of samples with very high concentrations of dissolved solids. Helping to prevent salt build-up inside the sample introduction system, the Argon Humidifier allows uninterrupted and maintenance-free operation.



ICP Model	Part No.
Optima 2x00/4x00/5x00/7x00/8x00 / Avio 200/500	N0775331

Elegra Argon Humidifier

The Elegra Argon Humidifier helps to alleviate salt deposits in the nebulizer and torch injector, allowing uninterrupted and maintenance-free operation.



ICP Model	Part No.
Optima 2x00/4x00/5x00/7x00/8x00 / Avio 200/500	N0781598

pergo Argon Humidifier

The *pergo* improves performance of all concentric nebulizers for the routine analysis of brines, fusion digests and other high-TDS samples. A high-pressure membrane positioned inside a temperature-controlled water reservoir perfuses water vapor into the ICP nebulizer gas stream. By increasing humidity in the argon nebulizer gas, the *pergo* prevents salt deposits at the nebulizer tip, improving short and long-term signal stability. *pergo 2* dual Argon humidifier is for analyses dealing with high concentrations of dissolved solids on instruments using auxiliary gas. Includes gas line connector kit.



ICP Model	Description	Part No.
Optima/Avio	<i>pergo 1</i> without Nebulizer	N8145315
Optima/Avio	<i>pergo 1</i> with MEINHARD Type C Nebulizer	N8145316
Optima/Avio	<i>pergo 1</i> with PFA-ST Nebulizer	N8150427

Cyclonic Spray Chambers



Standard Cyclonic Spray Chamber
Part No. **N0776052**



Cyclonic O-Ring Free Spray Chamber
Part No. **N0775351**

The spray chamber is an integral part of the sample introduction system responsible for filtering the sample mist to permit the appropriate droplet size distribution to reach the plasma.

Standard and O-Ring Free glass cyclonic spray chambers can be used with either GemCone or concentric glass nebulizers. HF resistant cyclonic spray chambers should be used with GemCone, SeaSpray or MicroMist nebulizers.

Glass Spray Chambers

ICP Model	Type	Part No.
2x00/4x00/5x00/7x00/8x00	Standard*	N0776052
2x00/4x00/5x00/7x00/8x00	O-Ring Free	N0775351
2x00/4x00/5x00/7x00/8x00	O-Ring Free with Easy-Seal Threaded	N0772017

*Standard Cyclonic Spray Chamber (**N0776052**) with Adapter (**N0770614**):
Spray Chamber Kit with Mount Part No. **N0770605**

Quartz Spray Chamber
Part No. **N0777036**



Quartz Spray Chambers

ICP Model	Type	Part No.
2x00/4x00/5x00/7x00/8x00	Non-baffled Cyclonic Spray Chamber	N0777635
2x00/4x00/5x00/7x00/8x00	7 mm Baffled Cyclonic Spray Chamber	N0777036
2x00/4x00/5x00/7x00/8x00	7 mm Baffled Micro Cyclonic Spray Chamber	N0777637
2x00/4x00/5x00/7x00/8x00	5 mm Baffled Micro Cyclonic Spray Chamber with additional gas port	N0777638

Include drain line (**N8141425**)

Cinnabar Spray Chamber
Part No. **N0777494**



Cinnabar™ Cyclonic Spray Chamber

The Cinnabar glass spray chamber is a mini-cyclonic spray chamber which gives good sensitivity at very low uptakes. The Cinnabar's design and low volume is ideal for the reduction of memory and matrix effects and very fast washout. Volume 20 mL.

ICP Model	Type	Part No.
2x00/4x00/5x00/7x00/8x00	O-Ring Free	N0777494

Twinnabar™ Cyclonic Spray Chamber

The Twinnabar glass cyclonic spray chamber is a low volume spray chamber with baffle combining the benefits of the Twister and the Cinnabar. It combines excellent precision with a very fast washout. Volume 20 mL.

ICP Model	Type	Part No.
2x00/4x00/5x00/7x00/8x00	O-Ring Free	N0777495

C2 Cyclonic Spray Chamber
Part No. **N0782012**



C2 Cyclonic Spray Chambers

The C2 dual cyclonic spray chamber improves both sensitivity and precision with its unique dual cyclonic aerosol flow path, improving detection limits. Even at very high sample flow rates, the C2 chamber significantly reduces droplet buildup in the injector that can cause plasma instability or outages.

Description	ICP Model	Part No.
Quartz C2 Dual Cyclonic Spray Chamber Threaded drain port, connection for ESI injector, drain line assembly included	2x00/4x00/5x00/7x00/8x00	N0782012
Quartz Hydride C2 Dual Cyclonic Spray Chamber Threaded drain port, connection for ESI injector, hydride gas port, drain line assembly included	2x00/4x00/5x00/7x00/8x00	N0782014

Baffled Cyclonic Spray Chambers



Baffled Cyclonic Spray Chamber
Part No. **N0791352**



Oxygen Port Spray Chamber
Part No. **N0777731**

The Baffled Cyclonic Spray Chamber features a central transfer tube which acts as a secondary particle separator, helping to separate larger aerosol particles from the sample. This reduces solvent load in the plasma without compromising detection limits.

ICP Model	Type	Part No.
Avio 200/500	O-Ring Free	N0791352
Avio 200/500 for Oil Analysis with Oxygen Port	O-Ring Free	N0770389
Avio 200 Quartz	O-Ring Free	N0791841
Avio 200 Quartz 8 mm PFA Adapter	O-Ring Free	N0791842
Avio 500 Quartz 12/5 Socket	O-Ring Free	N0811900
Avio 500 Quartz 8 mm PFA Adapter	O-Ring Free	N0811901
2x00/4x00/5x00/7x00 DV/8x00	Standard	N0776053
2x00/4x00/5x00/7x00 DV/8x00	O-Ring Free	N0775352
2x00/4x00/5x00/7x00 DV/8x00 for Oil Analysis (4 mm Baffle)	Standard	N0776090
2x00/4x00/5x00/7x00 DV/8x00 for Oil Analysis (4 mm Baffle)	O-Ring Free	N0775355
2x00/4x00/5x00/7x00 DV/8x00 for Oil Analysis (4 mm Baffle) with Oxygen Port	O-Ring Free	N0777731
4300V/5300V/7300V	Standard	N0771501
4300V/5300V/7300V	O-Ring Free	N0775356

Metal Ball Joint Clip



Used to connect spray chamber and torch.

Description	Part No.
Metal Ball Joint Clip	09200593

Spray Chamber Replacement Parts and Accessories



Part No. **N0770614**



Part No. **N0770600**



Part No. **N0777438**



Part No. **N0777439**



Part No. **N0791438**

Description	Part No.
Cyclonic Spray Chamber Adapter (Optima)	N0770614
Mounting Block Only (Optima)	N0770600
Drain Adapter Assembly for Scott Spray Chamber Includes the spray chamber fitting and tubing to pump out the waste solution from the spray chamber (does not include the peristaltic pump tubing)	N0770613
Carboy, 15 L	09904991
Drain Cap Assembly	N0690271
EzyLok Connector for Jacketed Spray Chamber, Pkg. 4	N0774101
Helix Locking Screw, Pkg. 1	N0777438
Helix Seal, Pkg. 4	N0777439
Nebulizer Adaptor Plug 16/6 for N0776052 Spray Chamber	N0776006
O-Ring Set for Nebulizer Adaptor Plug 16/6	N0776007
O-Ring Kit for Tracey TFE Spray Chamber (N077496) with Helix	N0777844
Nebulizer Spacer (Avio)	N0791438
Quick-Change Torch Module Support Stand (Optima)	N0770609



See Quick Change Torch Modules and Sample Introduction Kits on the following pages

HF Spray Chamber
Part No.
N0777497



HF Spray Chamber
Part No.
N0777496



HF Resistant Spray Chambers

ICP Model	Part No.
Avio 200/500 (with grounding strap)	N0790373
4300/5300/7300V TFE PTFE, 50 mL	N0777497
2x00/4x00/5x00/7x00 DV/8x00 TFE PTFE, 50 mL	N0777496
O-Ring Kit for N0777496 Spray Chamber	N0777844



PFA Spray Chambers

All-purpose spray chambers which offers resistance to hydrofluoric acid. Constructed entirely from chemically inert PFA, the PureChamber is available in low flow format for maximum aerosol transport and high flow format, ideal for ICP-AES applications. The PureCap accepts any 6 mm nebulizer but is ideally suited for the PFA MicroFlow nebulizer providing an O-Ring free PFA sample introduction system.

- Chemically inert PFA construction results in low contamination and long life time
- O-Ring free seal reduces contamination and provides an easy to clean low maintenance system

Description	ICP Model	Part No.
PFA 47 mm M-200	Avio 200/500	N0791847
PFA 47 mm M-200 with Gas Port	Avio 200/500	N0791848

Scott Spray Chamber
Part No. **N0770357**



Scott Spray Chamber
Part No. **N0790384**



Scott Spray Chambers

The Scott Spray Chamber is made from a corrosion-resistant material, which is inert to most mineral acids including HF, aqua regia and all organic solvents normally used in ICP analyses. The Scott-type design minimizes pulsations from the peristaltic pump.

ICP Model	Part No.
Avio 200/500	N0790384
2x00/4x00/5x00/7x00/8x00	N0770357

Scott Spray Chamber Replacement Parts

Description	Part No.
Scott Spray Chamber Clamp Adapter (Avio)	N0790296
O-Ring	09902033
End Cap Ring	00473543
End Cap (not complete assembly)	N0681688
Knurled Screw Qty. 2	00473539

Spray chamber, end cap and associated parts

Illustration shows cross-flow nebulizer end cap assembly Part No. **N0780546**.

Description	Part No.
1 Scott Spray Chamber	N0790384
2 O-Ring	09902033
3 End Cap Ring	00473543
4 End Cap (not complete assembly)	N0681688
5 Knurled Screw (2)	00473539

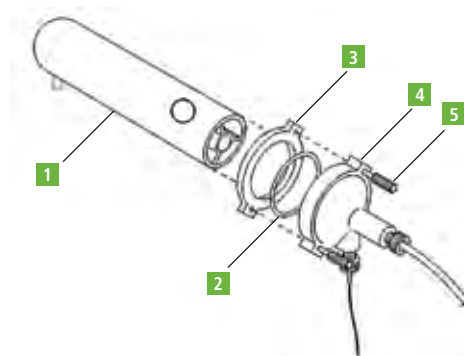

Temperature Controlled Spray Chambers

PC³ Peltier Temperature Controlled Spray Chambers

The PC^{3x} for Avio is a compact, Peltier-heated or cooled inlet system which incorporates the ESI cyclonic spray chamber. In cooling mode the PC^{3x} cools the outer walls of the cyclonic spray chamber that operates at -10°C to +80°C, reducing the water or solvent vapor loading on the plasma, resulting in enhanced stability and performance. In heating mode, sensitivity can be improved for low flow rate applications.

The PC³ is a compact Peltier cooled inlet system which incorporates the ESI cyclonic spray chamber. The peltier within the PC³ is air cooled, as such the system can be connected to any ICP. The PC³ cools the outer walls of the cyclonic spray chamber reducing the water or solvent vapor loading on the plasma resulting in enhanced stability and performance. The PC³-LT operates at -20°C to reduce the solvent load on the plasma for analysis of 100% volatile organic solvents.



PC^{3x} Spray Chamber



IsoMist Spray Chamber

IsoMist Temperature Controlled Spray Chambers

The IsoMist Programmable Temperature Controlled Spray Chamber provides the benefits of a temperature-controlled ICP sample introduction system in a compact, convenient package. The temperature is electronically controlled using a powerful inbuilt Peltier device. You can select any temperature between -10°C and +60°C in 1°C increments to provide the optimum conditions for any application. The rapid response of the Peltier device allows a spray chamber temperature of -5°C to be reached within 15 minutes.

The IsoMist XR programmable temperature controlled cyclonic spray chamber now features an improved thermodynamic design providing an extended temperature range and faster cool-down, so your ICP is ready to go sooner. IsoMist XR has a peltier unit with a range of -25°C to +80°C.

Features and Benefits

- Thermal stabilization of spray chamber improves long-term stability
- Default settings of spray chamber temperature (+2°C/ -5°C) for aqueous or organic solvents. Custom temperature settings are available upon request
- Interchangeable quartz, PFA and borosilicate cyclonic spray chambers available
- Fast rinse-out using PFA-ST nebulizer and O-Ring free quartz cyclonic spray chamber
- Reduced oxides

Features and Benefits

- Improve Analytical Stability
- Reduce Oxide Formation
- Perfect for Volatile Organics
- Constant Temperature Improves Analytical Stability
- Enhance Sensitivity with Elevated Sample Introduction Temperatures

Description	Part No.
PC³ Temperature Controlled Spray Chambers for Avio	
PC ^{3x} Peltier Cooled Cyclonic Spray Chamber for Avio 200	N0790959
PC ³ Peltier Cooled Cyclonic Spray Chamber for Avio 200	N0790953
PC ^{3x} Peltier Cooled Cyclonic Spray Chamber for Avio 500	N0810860
PC³ Temperature Controlled Spray Chambers for Optima	
PC ³ Organic Sample Introduction Kit, 1.5 mm Quartz injector	N0777354
PC ³ Organic Sample Introduction Kit	N0777355
HF PC ³ Organic Sample Introduction Kit, 1.5 mm Sapphire Injector	N0777824
PC ³ -LT Organic Sample Introduction Kit, 1.0 mm Quartz Injector	N0777356
PC ³ -LT Organic Sample Introduction Kit	N0777357
PC ^{3x} Complete system	N0777836
PC ^{3x} System with Baffled Quartz Spray Chamber and connector for ESI Injector*	N0786019
PC ^{3x} System for Optima V with Baffled Quartz Spray Chamber*	N0786020

*Injector and nebulizer are not included.

ICP Model	Description	Part No.
Avio	IsoMist XR Glass	N0810856
Avio	IsoMist XR PFA	N0810857
Avio	IsoMist XR Quartz	N0810858
Optima 4x00/5x00/7x00 DV/8x00	IsoMist XR Glass	N0780759
Optima 4x00/5x00/7x00 DV/8x00	IsoMist XR PFA	N0780760
Optima 4x00/5x00/7x00 DV/8x00	IsoMist XR Quartz	N0780761
Optima 4300/5300/7300 V	IsoMist XR Glass	N0770755
Optima 4300/5300/7300 V	IsoMist XR PFA	N0770756
Optima 4300/5300/7300 V	IsoMist XR Quartz	N0770757

Sample Introduction Quick Change Torch Modules

Part No. **N0790607**



Quick Change Torch Module Cyclonic Spray Chamber/Concentric Nebulizer

ICP Model	Part No.
Avio 200 Includes:	N0790607
Type K1 Standard Nebulizer	N0777707
1 Slot Quartz Torch	N0790131
2.0 mm Alumina Injector	N0791183
Baffled Cyclonic Spray Chamber	N0791352
Torch Body Assembly for Avio 200	N0790138
Injector Adapter	N0790141
Avio 500 Includes:	N0810607
Type K1 Standard Nebulizer	N0777707
1 Slot Quartz Torch	N0790131
2.0 mm Alumina Injector	N0791183
Baffled Cyclonic Spray Chamber	N0791352
Torch Body Assembly for Avio 500	N0810128
Injector Adapter	N0790141

Part No. **N0810606**



Quick Change Torch Module Scott Spray Chamber/Cross-Flow Nebulizer

ICP Model	Part No.
Avio 200 Includes:	N0790606
GemTip Cross-Flow Nebulizer	N0780546
1 Slot Quartz Torch	N0790131
2.0 mm Alumina Injector	N0791183
Scott Spray Chamber	N0791499
Torch Body Assembly for Avio 200	N0790138
Injector Adapter	N0790156
Avio 500 Includes:	N0810606
GemTip Cross-Flow Nebulizer	N0780546
1 Slot Quartz Torch	N0790131
2.0 mm Alumina Injector	N0791183
Scott Spray Chamber	N0791499
Torch Body Assembly for Avio 500	N0810128
Injector Adapter	N0790156

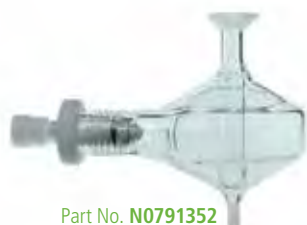

Part No. **N0791352**



Part No. **N0770358**

Organics Sample Introduction System

ICP Model	Part No.
Avio 200 Includes:	N0790611
GemCone Low-Flow Nebulizer	N0770358
Injector Adapter Kit-Cyclonic with O-Rings	N0790141
Hybrid XLT 3 Slot Torch Avio	N0790249
Alumina Injector 1.2 mm Length Avio	N0791182
Baffled Cyclonic Spray Chamber Avio	N0791352
Torch Body Assembly for Avio 200	N0790138
Avio 500 Includes:	N0810609
GemCone Low-Flow Nebulizer	N0770358
Injector Adapter Kit-Cyclonic with O-Rings	N0790141
Hybrid XLT 3 Slot Torch Avio	N0790249
Alumina Injector 1.2 mm Length Avio	N0791182
Baffled Cyclonic Spray Chamber Avio	N0791352
Torch Body Assembly for Avio 500	N0810128

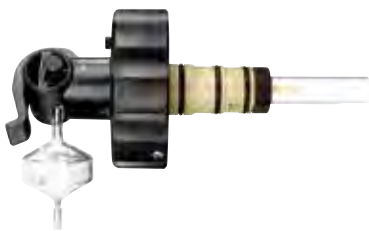

Quick-Change Torch Module with Cyclonic Spray Chamber and Concentric Nebulizer

ICP Model	Part No.
Optima 8x00 Includes:	N0780607
MEINHARD Type K1 Nebulizer 1 mL/Min	N0777707
1 Slot Quartz Torch	N0780130
Alumina Injector 2.0 mm ID	N0781014
Polyethylene Tubing, 10 ft.	09908265
Adjustable Torch Assembly	N0770600
Cyclonic Spray Chamber with Adjustable Mount	N0770605
Tubing Assembly	N0770610
Optima 2x00/4x00/5x00/7x00 Includes:	N0770607
MEINHARD Type C1 Nebulizer 1 mL/Min	00472022
Polyethylene Tubing, 10 ft.	09908265
1 Slot Quartz Torch	N0770338
Adjustable Torch Assembly	N0770600
Cyclonic Spray Chamber with Adjustable Mount	N0770605
Tubing Assembly	N0770610
Alumina Injector 2.0 mm	N0775177

Quick-Change Torch Module for HF Analysis

ICP Model	Part No.
Optima 4300V/5300V/7300V Includes:	N0770911
GemCone High Dissolved Solids Nebulizer	N0690670
Alumina Sample Injector 2.0 mm ID	N0695362
Quick Disconnect Tubing	N0770336
3 Slot Quartz Torch	N0771500
Tracey TFE Spray Chamber Includes: Fittings, O-Rings and Spares	N0777497

Quick-Change Torch Module for Oil Analysis

ICP Model	Part No.
Optima 4300V/5300V/7300V Includes:	N0770910
GemCone Low-Flow Nebulizer	N0770358
Alumina Injector 1.2 mm	N0771531
Quick Disconnect Tubing	N0770336
3 Slot Quartz Torch	N0771500
Baffled Cyclonic Spray Chamber Includes: Fittings, O-Rings and Spares	N0771501



Quick-Change Torch Module with Scott Spray Chamber and GemTip Cross-Flow II Nebulizer

ICP Model	Part No.
Optima 8x00 Includes:	N0780606
1 Slot Quartz Torch	N0780130
GemTip Cross-Flow II Nebulizer	N0780546
Alumina Injector 2.0 mm ID	N0781014
Scott Spray Chamber	N0770357
Optima 2x00/4x00/5x00/7x00 DV Includes:	N0770606
1 Slot Quartz Torch	N0770338
GemTip Cross-Flow II Nebulizer	N0770546
Adjustable Torch Assembly	N0770600
Alumina Injector 2.0 mm	N0775177
Scott Spray Chamber	N0770357

Mounting Block

Mounting block only. Does not include torch, injector, spray chamber or nebulizer.



ICP Model	Part No.
Optima 2x00/4x00/5x00/7x00/8x00	N0770600

Quick-Change Torch Module Support Stand

A free-standing support stand to hold your spare Quick-Change Torch Module.



ICP Model	Part No.
Optima 2x00/4x00/5x00/7x00 DV/8x00	N0770609

End Cap for Concentric Glass, GemCone and Similar Nebulizers

End cap to fit any concentric nebulizer onto a Scott Spray Chamber.



ICP Model	Part No.
Optima 2x00/3x00/4x00/5x00/7x00/8x00 / Avio 200/500	N0680504

Sample Introduction Kits



Part No. **N0777707**



Part No. **N0791352**



Part No. **N0780546**



Part No. **N0790384**

Cyclonic/Concentric Kits

ICP Model	Part No.
Avio 200/500 Includes:	N0790608
1 Slot Quartz Torch	N0790131
2.0 mm ID Alumina Injector	N0791183
Baffled Cyclonic Spray Chamber	N0791352
MEINHARD® Type K1 Nebulizer	N0777707
Injector Adapter	N0790141
Optima 8x00 Includes:	N0780617
1 Slot Quartz Torch	N0780130
2.0 mm ID Alumina Injector	N0781014
Glass Cyclonic Spray Chamber	N0776052
MEINHARD® Type K1 Nebulizer	N0777707
Quartz Torch Copper Ignitor Tape – Qty. 50 pcs.	N0781097
Optima 2x00/4x00/5x00/7x00 DV Includes:	N0770730
1 Slot Quartz Torch	N0770338
Quartz Bonnet	N0775289
2.0 mm ID Alumina Injector	N0775177
Glass Cyclonic Spray Chamber	N0776052
MEINHARD® Type C High Dissolved Solids Nebulizer	00472022
Quartz Torch Copper Ignitor Tape – Qty. 120 pcs.	N0775297

Scott/Cross-Flow II Kits

ICP Model	Part No.
Avio 200/500 Includes:	N0790609
1 Slot Quartz Torch	N0790131
2.0 mm ID Alumina Injector	N0791183
Scott Spray Chamber	N0790384
GemTip™ Cross-Flow II Nebulizer	N0780546
Injector Adapter	N0790156
Scott Spray Chamber Clamp Adapter	N0790296
Optima 8x00 Includes:	N0780616
1 Slot Quartz Torch	N0780130
2.0 mm ID Alumina Injector	N0781014
Scott Spray Chamber	N0770357
GemTip™ Cross-Flow II Nebulizer	N0780546
Quartz Torch Copper Ignitor Tape – Qty. 50 pcs.	N0781097
Optima 2x00/4x00/5x00/7x00 DV Includes:	N0770731
1 Slot Quartz Torch	N0770338
Quartz Bonnet	N0775289
2.0 mm ID Alumina Injector	N0775177
Scott Spray Chamber	N0770357
GemTip™ Cross-Flow II Nebulizer	N0770546
Quartz Torch Copper Ignitor Tape – Qty. 120 pcs.	N0775297



Part No. **N0771500**



Part No. **N0772006**

Oxygen Addition Kits

ICP Model	Qty.	Part No.
Oxygen Addition Kit Avio 200/500 Includes:		N0790412
Baffled Cyclonic Spray Chamber 4 mm for Oils with Oxygen Port	1	N0770389
Tygon Tubing	25 ft.	02506516
Insert	4	09903094
Tube Fitting	2	09903150
Mass Flow Controller	1	N0772006

ICP Model	Qty.	Part No.
DV Oxygen Addition Kit Optima 2x00/4x00/5x00/7x00/8x00 DV Includes:		N0770689
Baffled Cyclonic Spray Chamber 4 mm for Oils with Oxygen Port	1	N0777731
Tygon Tubing	25 ft.	02506516
Insert	4	09903094
Tube Fitting	2	09903150
Mass Flow Controller	1	N0772006
Adapter for Cyclonic Spray Chamber	1	N0770614

ICP Model	Qty.	Part No.
V Oxygen Addition Kit Optima 4300 V/5300 V/7300 V Includes:		N0770965
Torch Adapter with Auxiliary Oxygen Port	1	N0774070
Tygon Tubing Per l/0.3 m	25 ft.	02506516
Insert	4	09903094
Tube Fitting	2	09903150
Mass Flow Controller	1	N0772006

Hydride Accessory Kit

ICP Model	Qty.	Part No.
Hydride Accessory Kit Avio 200/500 Includes:		N0810433
Silicone Tubing ID 5mm Thickness x 2 mm	1	B0018283
PVC Tube 3X1 TR 75 Shore	1	B0048139
PTFE Tubing, 110 mm	1	B0191058
PTFE Tubing, 700 mm	1	B0191059
1.52 mm ID Tubing, Blue/Yellow/Blue, Pkg. 12	1	B0193161
Adapter A/D with Intern Screw Thread 1.8mm	1	B0193342
Adapter C / D = 4,0	1	B0196850
Adapter E / D = 6,0	1	B0196857
Tubing Connector for FIAS-400MS	2	B0196882
PTFE Tubing, 300 mm	2	B0198097
Tubing Adapter K	1	B0507918
Mixing/Separation Assembly	1	B0507957
PTFE Membrane, Pkg. 50	1	B0508306
3.18 mm ID, Black/White/Black Pkg. 12	1	B0508310
PVC Tubing for 2 mL/mm, P40	1	N0680375
Ultrasonic Axial Adapter	1	N0695426
Quick Disconnect Tubing for 2000/4000	1	N0770336
Glass Ball Joint Adapter	1	N8126045

Organics Kits

ICP Model	Qty.	Part No.
Avio 200/500 Includes:		N0790610
3 Slot Quartz Torch	2	N0790249
1.2 mm ID Alumina Injector (1.2 mm entire length of tube)	2	N0791182
Baffled Cyclonic Spray Chamber	1	N0791352
GemCone™ Low-Flow Nebulizer	1	N0770358
Cyclonic Spray Chamber Adapter	1	N0790141
Nebulizer Spacer	1	N0791438
Optima 8x00 Includes:		N0780608
3 Slot Quartz Torch	2	N0780132
1.2 mm ID Alumina Injector	2	N0781007
Baffled Cyclonic Spray Chamber 4 mm	1	N0776090
GemCone™ Low-Flow Nebulizer	1	N0770358
Cyclonic Spray Chamber Adapter	1	N0770614
Injector Adapter Washer	1	N0776014
Injector Adapter	1	N0776091
Injector Adapter Nut	1	N0776025
O-Ring	1	09902207
O-Ring 8.74 ID 1.78 WD	2	09921028
Optima 2x00/4x00/5x00/7x00 DV Includes:		N0770420
3 Slot Quartz Torch	1	N0772005
1.2 mm ID Alumina Injector	1	N0776093
Baffled Cyclonic Spray Chamber 4 mm	1	N0776090
GemCone™ Low-Flow Nebulizer	1	N0770358
Cyclonic Spray Chamber Adapter	1	N0770614
Injector Adapter Washer	1	N0776014
Injector Adapter Nut	1	N0776025
Injector Adapter	1	N0776091
O-Ring	1	09902207
O-Ring 8.74 ID 1.78 WD	2	09921028
Optima 4300 V/5300 V/7300 V Includes:		N0770732
3 Slot Quartz Torch	1	N0771500
Quartz Bonnet	1	N0775289
1.2 mm ID Alumina Injector	1	N0771531
Baffled Cyclonic Spray Chamber	1	N0771501
GemCone™ Low-Flow Nebulizer	1	N0770358
Quartz Torch Copper Ignitor Tape	120	N0775297

Demountable Quartz Torches

Avio Torch
Part No. **N0790131**



Demountable design using one-piece quartz tubing for plasma and auxiliary gas flow. Torches without slots are recommended for organic solvents. 1-slot torches are the standard torch for aqueous solutions. 3-slot torches are typically used for organic analysis.

ICP Model	No. of Slots	Part No.
Avio 200/500 (Standard Torch)	1	N0790131
Avio 200/500 (with PVDF O-Ring-free holder)	1	N0811908
Avio 200/500 Organics (not ceramic)	3	N0790249
8x00 HybridXLT (ceramic tip)	1	N0780128
8x00	0	N0780133
8x00 (Standard)	1	N0780130
8x00	3	N0780132
2x00/4x00/5x00/7x00 DV	0	N0770343
2x00/4x00/5x00/7x00 DV (short ver.)	0	N0770344
2x00/4x00/5x00/7x00 DV	1	N0770338
2x00/4x00/5x00/7x00 DV	3	N0772005
2x00/4x00/5x00/7x00 DV Organics	3	N0772008
4300V/5300V/7300V	3	N0771500
7300 V Organics	3	N0771561

Fixed Torches can be found on the next page.

Torch Bonnet

The torch bonnet is used as a spacer between the torch and RF load coil.



ICP Model	Part No.
2x00/4x00/5x00/7x00	N0775289

Copper Ignitor Tape



ICP Model	Qty.	Part No.
8x00	50	N0781097*
2x00/4x00/5x00/7x00	120	N0775297

*Ignitor tape for Optima and HybridXLT Torches

Torch Body Assemblies

ICP Model	Part No.
Avio 200	N0790138
Avio 500	N0810128

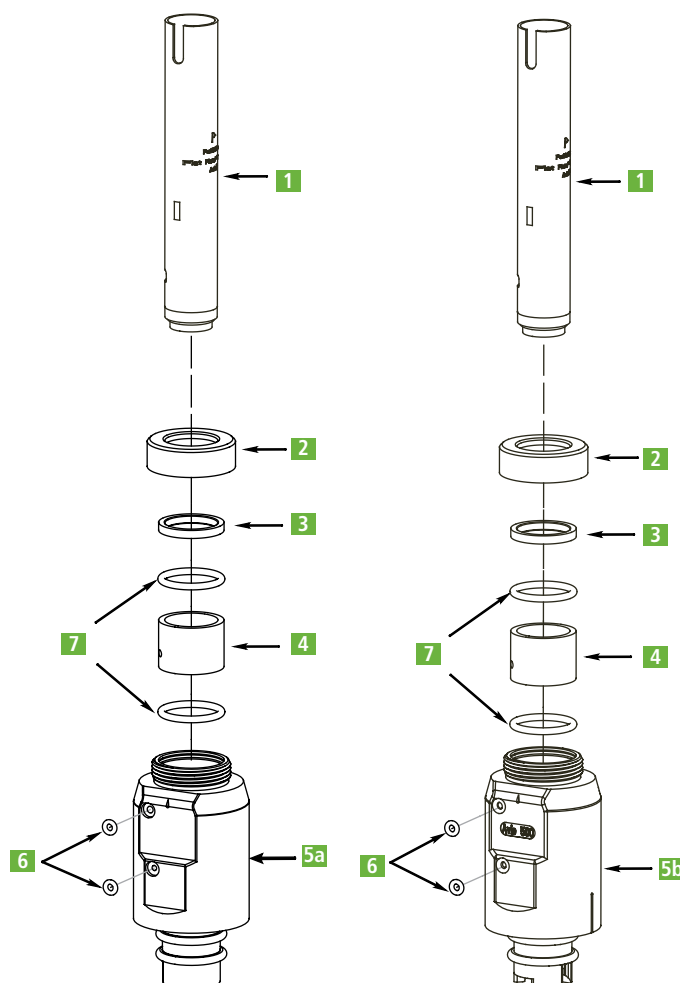

Avio 200 Torch Body Assembly
Part No. **N0790138**

Avio 500 Torch Body Assembly
Part No. **N0810128**

Torch Body Assembly Replacement Parts

Description	Part No.
1 Torch Glass	N0790131
2 Knurled Nut	N0776027
3 Washer	N0776028
4 Spacer	N0791125
5a Cassette for Avio 200 Torch Body Assembly	N0790214
5b Cassette for Avio 500 Torch Body Assembly	N0810214
6 O-Ring Color Coded Blue	N0791334
7 O-Ring	09902223



Torch O-Ring Kits

ICP Model	Part No.
Avio 200/500 O-Ring Kit for Adjustable Torch Includes: 0.799 ID 0.103 WD 09902223 (2) 0.101 ID 0.070 WD N0791334 (2)	N0790437
Avio 200/500 O-Ring Kit for Scott Injector Includes: 8.74 ID 1.78 WD 09200518 (2) 0.239 ID 0.70 WD 09902207 (2) 0.344 ID 0.070 WD N0791333 (2)	N0790440
Avio 200/500 O-Ring Kit for Cyclonic Injector Includes: 0.239 ID 0.70 WD 09902207 (2) 0.301 ID 0.70 WD 09926070 (2) 0.344 ID 0.070 WD N0791333 (2)	N0790441
8x00 Complete O-Ring Kit Includes: 1.171 ID, 0.139 WD 09902131 (1) 0.799 ID, 0.103 WD 09902223 (2) 1.109 ID, 0.139 WD 09921061 (1) 1.046 ID, 0.139 WD 09921062 (1)	N0780437
2x00/4x00/5x00/7x00 DV Complete O-Ring Kit Includes: 0.801 ID 0.070 WD 09902045 (1) 1.171 ID 0.139 WD 09902131 (1) 0.799 ID 0.103 WD 09902223 (2) 1.109 ID 0.139 WD 09921061 (1) 1.046 ID 0.139 WD 09921062 (1)	N0770437
4300V/5300V/7300V Complete O-Ring Kit Includes: 0.612 ID 0.103 WD 09902155 (1) 0.239 ID 0.070 WD 09902207 (2) 0.364 ID 0.070 WD 09902247 (2) 0.301 ID 0.070 WD 09926070 (1)	N0770916
Avio 200/500	0.101 ID, 0.070 WD N0791334
Avio 200/500	0.344 ID, 0.070 WD N0791333
Avio 200/500	8.74 ID, 1.78 WD 09200518
2x00/4x00/5x00/7x00 DV/8x00 (Viton)	1.171 ID, 0.139 WD 09902131
2x00/4x00/5x00/7x00 DV/8x00 (Viton)	0.799 ID, 0.103 WD 09902223
2x00/4x00/5x00/7x00 DV/8x00	1.109 ID, 0.139 WD 09921061
2x00/4x00/5x00/7x00 DV/8x00	1.046 ID, 0.139 WD 09921062
2x00/4x00/5x00/7x00 DV/8x00	0.801 ID, 0.070 WD 09902045
4300V/5300V/7300V (For Ball Joint)	0.301 ID, 0.070 WD 09926070
3x00 XL/3x00 DV/3000 SCX	0.239 ID, 0.070 WD 09902006
3x00 XL/3x00 DV/3000 SCX	0.364 ID, 0.070 WD 09902015
3x00 XL/3x00 DV/3000 SCX	8.74 ID, 1.78 WD 09921028
3x00 XL/3x00 DV/3000 SCX/4300V/5300V/7300V (Inside)	0.239 ID, 0.070 WD 09902207
3x00 XL/3x00 DV/3000 SCX/4300V/5300V/7300V (Outside)	0.301 ID, 0.070 WD 09902247
All, O-Ring Lube 2 grams	09200078
O-Ring Removal Tool	09220410

Fixed Torches

One Piece Fixed Quartz Torches with PVDF O-Ring Free Holders



Part No. **N0811902**

The one-piece torch has the injector integrated directly into the torch.

ICP Model	Description	Part No.
Avio 200/500	One Piece Quartz Torch with 1mm injector	N0811902
Avio 200/500	One Piece Quartz Torch with 1.5mm injector	N0811903
Avio 200/500	One Piece Quartz Torch with 2mm injector	N0811906
Avio 200/500	One Piece Quartz Torch with 2.5mm injector	N0811907

Ceramic Hybrid XLT Quartz Torch

PerkinElmer's HybridXLT™ torch is the latest addition to the family of PerkinElmer genuine sample introduction components. The ceramic/quartz hybrid design provides the highest performance for your Optima® ICP-OES 8x00 spectrometer. Available only from PerkinElmer, this torch has an extended lifetime of up to 10x your current quartz torch, increasing instrument uptime and decreasing maintenance costs.



Features and Benefits

- Extended Torch Lifetime – up to 10x improvement
- Viewable plasma compared to a full ceramic design
- Ideal for all sample types, except organic solvents
- Increased instrument uptime
- Lower cost per analysis
- Exclusive patented design
- Lower cost than full ceramic torches

Only From PerkinElmer!

ICP Model	No. of Slots	Part No.
8x00	1	N0780128

D-Torch Demountable Torch

D-Torch Demountable Torch
Part No. **N0790442**



The D-Torch™ provides a demountable torch design without sacrificing performance or usability. Featuring a torch body with fixed alumina intermediate tube for greater robustness, in addition to a demountable outer tube and injector, the D-Torch significantly reduces torch replacement costs for the analysis of challenging sample matrices.

The optional ceramic outer tube is of particular benefit for ICP applications where a quartz outer tube will suffer from a short lifetime. High TDS applications cause quartz to rapidly devitrify and organic solvents can cause quartz to fracture, whereas the ceramic outer tube will last years under the same conditions.

Features and Benefits

- Analysis of high-matrix solutions (i.e. fusion samples, samples with high-dissolved solids, samples with high-acid content) which can cause early devitrification or sample deposition when using quartz
- Demountable outer tube – With the D-Torch, you need only replace the outer tube
- Interchangeable quartz and ceramic outer tubes
- Interchangeable injectors – choose the optimum injector for your application. Select from quartz for aqueous solutions, narrow bore for organics, wide bore for high dissolved solids or ceramic for HF

D-Torch™ and Replacement Parts

ICP Model	Description	Part No.
Avio 200	D-Torch Complete Assembly with Quartz Outer Tube	N0790442
Avio 500	D-Torch Complete Assembly with Quartz Outer Tube	N0810861
Avio 200	D-Torch Ceramic Outer Tube (optional)	N0791303
Avio 500	D-Torch Ceramic Outer Tube (optional)	N0811912
Avio 200	D-Torch Body	N0791300
Avio 500	D-Torch Body	N0811904
Avio 200/500	D-Torch Outer Tube	N0791301
8x00	D-Torch Assembly including Quartz Outer Tube	N0777840
8x00	Ceramic Outer Tube (optional)	N0777880
8x00	Base and Inner Tube	N0777841
8x00	Quartz Outer Tube	N0777842
2x00/4x00/5x00/7x00*	DV D-Torch Quartz including Outer Tube	N0777508
2x00/4x00/5x00/7x00	DV Base and Inner Tube	N0777509
2x00/4x00/5x00/7x00	DV Quartz Outer Tube	N0777510
4300/5300/7300V	D-Torch with Quartz Outer Tube	N0777051
4300/5300/7300V	Quartz Outer Tube	N0777053
4300/5300/7300V	Ceramic Outer Tube	N0777052
4300/5300/7300V	Base and Inner Tube	N0777054
	Retaining Ring for Outer Tube	N0777055
	Copper Tape for D-Torch Outer Tube	N0777843
	O-Ring Kit	N0777715
	Torch Adapter with Auxiliary Port	N0774070

*Ceramic outer tube is not available for this model



Ceramic D-Torch Assembly
Part No. **N0777840**



Ceramic D-Torch with Quartz Outer Tube
Part No. **N0777051**



Base and Inner Tube
Part No. **N0777054**



Ceramic Outer Tube
Part No. **N0777880**



Quartz Outer Tube
Part No. **N0777053**

Load Coils and Purge Components

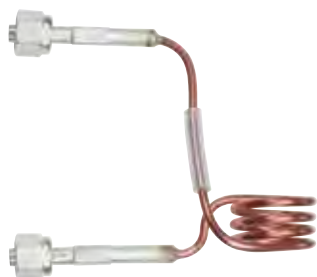

RF Load Coils*

ICP Model	Part No.
2x00/4x00/5x00/7x00 DV	N0775300
4300V/5300V/7300V	N0771536
3x00 XL/3x00 DV	N0690772
3000/3000 SCR/3x00 RL (For instruments manufactured AFTER 9/21/94)	N0690668

* Installation by PerkinElmer Service is required, but not included

RF Load Coil Accessories

Description	Part No.
Igniter Spark Gap Assembly for Type II Demountable Torch	N0680275
Nylon Igniter Standoff	09989859

Purge Component Replacement Parts

Description	Part No.
For 5x00/7100/7200/7300 DV/8300	
O-Ring (for Dual View Radial Purge Tube)	09200064
O-Ring (for Dual View Axial Purge Window)	09902143
O-Ring (for Torch Clamp on Vertical Torch Module)	09902155
DV Axial Window Cap	N0773084
DV Axial Window Holder	N0773090
For Optima 2100/7000/8000	
O-Ring (for Dual View Radial Purge Tube)	09921036
O-Ring (for Dual View Axial Purge Window)	09921062
Purge Outlet O-Ring	09921057



Nitrogen Purge Gas Generator

Description	Part No.
Nitrogen Purge Gas Generator without Air Compressor, 115V, 60 Hz.	N0695468
Nitrogen Purge Gas Generator without Air Compressor, 220 V, 50 Hz.	N0695469

Radial Window
Part No. **N0581497**

Axial Window
Part No. **09992731**



Purge Extension Windows

The Axial View Purge Extension Window is a replaceable quartz window that slides into the purge extension between the torch and the optics. The Radial View Purge Extension Window Tube is a replaceable quartz tube that slides into the mount between the torch and the optics for the radial view.

ICP Model	Description	View	Part No.
Avio 200/500	Purge Window	Axial	09992731
Avio 200	Purge Window	Radial	N0690672
Avio 500	Purge Window	Radial	N0810346
Avio 200	Optical Kit (includes Windows O-Rings)	Axial/Radial	N0790439
Avio 200 Axial	Flat Mirror Kit	Axial	N0790196
Avio 500	Optical Kit (includes Windows and O-Rings)	Axial/Radial	N0810439
Avio 500	Flat Mirror Kit	Axial	N0810194
2x00/7000/8000	Purge Window	DV Axial	09992731
2x00/7000/8000	Purge Window	DV Radial	N0690672
2X00 (long tube)	Purge Window	Radial	B0810377
3x00/4x00/5x00/7100 /7200/7300 DV /8300	Purge Window	DV Axial	N0771116
5x00/7100/7200/7300 DV/8300	Purge Window	DV Radial	N0770944
3x00 DV (tube)	Purge Window	DV Axial	N0691678
3x00 DV (long tube) (38 mm/1.5 in.)	Purge Window	DV Radial	N0691689
3000 SCX/3x00 XL	Purge Window	Axial	09992731
3000/3000 SCR/3x00 RL /4300V/5300V/7300V	Purge Window	Radial	N0581497
4x00 DV/5x00 DV**	Purge Window	DV Radial	N0770322

** Pre November 2004

Injectors



Alumina Injectors

Alumina injectors are corrosion-resistant to all mineral acids including HF and aqua regia. They are also used with less volatile organic solvents, e.g., xylene.

ICP Model	Dimensions	Part No.
Avio 200/500	0.80 mm ID	N0791180
Avio 200/500	1.2 mm ID	N0791181
Avio 200/500 (1.2 mm entire length of tube)	1.2 mm ID	N0791182
Avio 200/500 (standard with Avio instrument)	2.0 mm ID	N0791183
8x00	0.80 mm ID	N0781009
8x00	1.2 mm ID	N0781015
8x00 (1.2 mm entire length of tube)	1.2 mm ID	N0781007
8x00	2.0 mm ID	N0781014
2x00/4x00/5x00/7x00 DV	0.80 mm ID	N0775227
2x00/4x00/5x00/7x00 DV	1.2 mm ID	N0775228
2x00/4x00/5x00/7x00 DV (1.2 mm entire length of tube)	1.2 mm ID	N0776093
2x00/4x00/5x00/7x00 DV	2.0 mm ID	N0775177
4300V/5300V/7300V	1.2 mm ID	N0771531
3000/3000 SCR/3x00 RL	0.85 mm ID	N0582186
3000/3000 SCR/3x00 RL	1.5 mm ID	N0582185
3000/3000 SCR/3x00 RL	2.0 mm ID	N0582184
3x00 XL/3x00 DV/3000 SCX /4300V/5300V/7300V	2.0 mm ID	N0695362



Sapphire Injectors

Sapphire injectors are ideal for silicon applications

ICP Model	Dimensions	Part No.
Avio 200/500	2.0 mm ID	N0791184
8x00	2.0 mm ID	N0781008
2x00/4x00/5x00/7x00 DV Sapphire in PFA base, (connects directly to ESI spray chambers)	1.8 mm ID	N0777044
2x00/4x00/5x00/7x00 DV	2.0 mm ID	N0775247
3000/3000 SCR/3x00 RL	2.0 mm ID	N0695495
3x00 XL/3x00 DV/3000 SCX /4300V/5300V/7300V	2.0 mm ID	N0695494

Quartz Injectors

Quartz injectors are designed for organic solvents and non-HF matrices.

ICP Model	Dimensions	Part No.
Avio 200/500	0.80 mm ID	N0791185
Avio 200/500	1.2 mm ID	N0791186
Avio 200/500 (1.2 mm entire length of tube)	1.2 mm ID	N0791187
Avio 200/500	1.6 mm ID	N0791188
Avio 200/500	2.0 mm ID	N0791189
Avio 200/500	3.0 mm ID	N0791190
8x00	0.80 mm ID	N0781018
8x00	1.2 mm ID	N0781019
8x00 (1.2 mm entire length of tube)	1.2 mm ID	N0781013
8x00	1.6 mm ID	N0781016
8x00	2.0 mm ID	N0781050
8x00	3.0 mm ID	N0781017
2x00/4x00/5x00/7x00 DV	0.80 mm ID	N0775225
2x00/4x00/5x00/7x00 DV	1.2 mm ID	N0775226
2x00/4x00/5x00/7x00 DV	1.6 mm ID	N0775223
2x00/4x00/5x00/7x00 DV	2.0 mm ID	N0775014
2x00/4x00/5x00/7x00 DV	3.0 mm ID	N0775224
4300V/5300V/7300V	0.8 mm ID	N0695461
4300V/5300V/7300V	1.2 mm ID	N0695460
4300V/5300V/7300V	1.6 mm ID	N0695449
4300V/5300V/7300V	2.0 mm ID	N0695442

ESI Demountable Injectors

Dimensions	Type	Part No.
For Avio 200/500		
2.0 mm	Platinum	N0791849
1.5 mm	Sapphire	N0791850
2.0 mm	Sapphire	N0791851
For Optima 8x00		
2.0 mm	Platinum	N0786021
1.5 mm	Sapphire	N0782004
1.8 mm	Sapphire	N0782005
1.8 mm with adapter for 7x00	Sapphire	N0782006
2.5 mm	Sapphire	N0786022
1 mm	Quartz	N0782007
1.5 mm	Quartz	N0782008
2 mm	Quartz	N0782009
2.5 mm	Quartz	N0782010
For Optima 4x00, 5x00, 7x00		
1.5mm	Sapphire	N0777630
1.8mm	Sapphire	N0777044
2.5mm	Sapphire	N0777374
1.0mm	Quartz	N0777631
1.5mm	Quartz	N0777632
2.0mm	Quartz	N0777633
2.5mm	Quartz	N0777634
2.0mm	Platinum	N0777373

Avio Injector Assembly

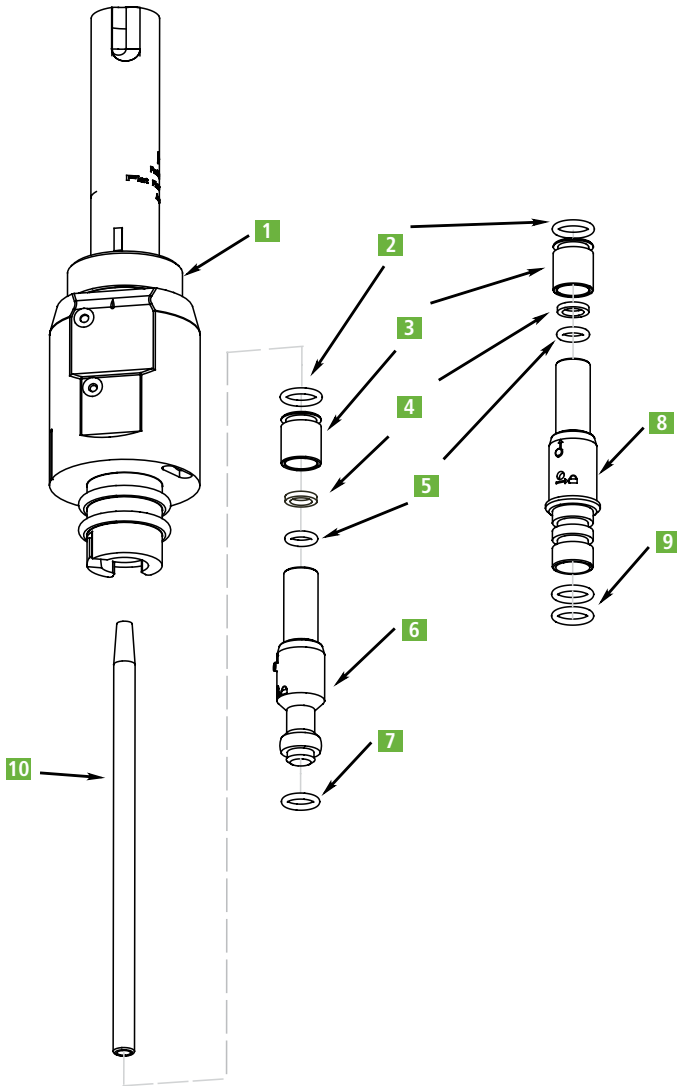

Description	Part No.
1 Knurled Nut	
2 O-Ring – Color Coded Blue	N0791333
3 Lock Collar	N0791163
4 Washer	N0776014
5 O-Ring	09902207
6 Cyclonic Injector Adapter	N0790143
7 O-Ring	09926070
8 Scott Injector Adapter	N0790154
9 O-Ring	09200518
10 Injector 2 mm Alumina	N0791183



Avio Injector Assembly Replacement Parts

Description	Part No.
Cyclonic Injector Assembly	N0790141
Scott Injector Assembly	N0790156
O-Ring Kit for Avio Scott Injector	N0790440
O-Ring Kit for Avio Cyclonic Injector	N0790441
O-Ring Kit for Avio Torch	N0790437
O-Ring Removal Tool	09220410

Injector Support Adapters and Replacement Parts

Injector Support Adapters

ICP Model	Spray Chamber	Part No.
Avio 200/500 Includes one of each: 09902207 , 09926070 , N0791333 , N0776014 , N0790143 , N0791163	Cyclonic	N0790141
Avio 200/500 Includes one of each: 09902207 , 09200518 , N0791333 , N0776014 , N0790154 , N0791163	Scott	N0790156
2x00/4x00/5x00/7x00 DV 8x00	All	N0770603
2x00/4x00/5x00/7x00 DV 8x00*	All	N0776091
4300V/5300V/7300V (bottom)	Cyclonic	N0771526
4300V/5300V/7300V (top)	Cyclonic	N0771527

*For 1.2 mm entire length injectors **N0776093** and **N0781007**

Injector Support Adapter O-Ring Kits

ICP Model	Part No.
Avio 200/500 Cyclonic	N0790441
Avio 200/500 Scott	N0790440
2x00/4x00/5x00/7x00 DV/8x00	N0770438
3000/3000 SCR/3X00 RL	N0690269
3x00 XL/3x00 DV/3000 SCX	N0690769

Oil-Less Air Compressors

PerkinElmer is expanding its product portfolio to include an industrial grade quiet oil-less compressor with a 2 year manufacturer's warranty for a dependable, clean and dry air supply. Each compressor comes assembled on an internally and externally coated air tank carrying a 5 year manufacturer's warranty. Also included are an optional self-purging regenerative air dryer, aftercooler and 5 micron line filters assuring that the compressed air delivered to the instrument is of highest quality moisture and particle free. One version includes a silencing cabinet resulting in a compressor operating at a very quiet noise level of 55 dB/A. All models are equipped with ASME rated pressure tanks and safety valves, line pressure regulator, gauges and line ball valve for a complete turnkey compressor station.



Air Compressor with Dryer
Part No. **N077602**



Specifications		
Horse Power		1.5 HP
Output CFM/Output L		6.0 CFM/170 L/min
Max Pressure PSI/Max Pressure Bar		120 PSI/8 bar
Noise Level		72 dB/A, with Enclosure 55 dB/A
Tank Size Gal./Tank Size L		13 Gal./50 L
Dimensions	without Enclosure with Enclosure	25 in. x 18 in. x 29 in. 29 in. x 23 in. x 32 in.
Weight	without Enclosure with Enclosure	97 lbs. 207 lbs.
Packed Dimensions	without Enclosure with Enclosure	28 in. x 21 in. x 29 in. 33 in. x 28 in. x 39 in.

Compressors

Description	115 V/60 Hz Part No.	220 V/50 Hz Part No.	220 V/60 Hz Part No.
Air Compressor	N077881	N077882	N077883
Air Compressor with Dryer	N077602	N077603	N077604
Air Compressor with Dryer in Silencing Cabinet	N077605	N077606	N077607

Product meets both U.S. and Canadian CSA standards. ASME® certified tank
Please note: Silencing cabinet cannot be sold separately

Replacement parts

Description	Part No.
Replacement Air Intake Filter	N077608
Micron Dryer Filter Element	N077609
Replacement Piston Assembly	N077610
Replacement Reed Valve	N077611
Replacement Head Gasket	N077612



FAST High Productivity Systems

The FAST is a high-throughput automated sample introduction system for PerkinElmer ICP-OES and ICP-MS. The FAST increases productive instrument time by reducing sample uptake, stabilization and rinse steps, allowing you to run more samples each day.

Features and Benefits

- Sample never touches peristaltic pump tubing
- FAST uptake, stabilization and washout
- P-Series valve and loop combination has superb washout
- Carrier stream without segmented air bubbles ensures high-precision sample introduction
- Direct integration of MP² peripump and FAST valve with instrument



4 DX FAST DXi System for Optima ICP-OES

Description	Type	Part No.
2 DX FAST DXi System Optima	2 Rack	N0777618
4 DX FAST DXi System Optima	4 Rack	N0777612
2 DX FAST DXi System Avio 200	2 Rack	N0790964
4 DX FAST DXi System Avio 200	4 Rack	N0790965
2 DX FAST DXi System Avio 500	2 Rack	N0810870
4 DX FAST DXi System Avio 500	4 Rack	N0810871

8 rack and 14 rack FAST DXi Systems are also available

prepFAST Autodilution and Autocalibration Systems

prepFAST is an inline dilution system that automatically performs precise and accurate dilutions for samples and standards, improving laboratory workflow, productivity and data quality.

Features and Benefits

- Autodilution
- Auto QC dilution
- Autocalibration
- Automatic standard addition
- Automatic IS addition



2 DX prepFAST System for Avio ICP-OES

Description	Type	Part No.
2 DX prepFAST System Optima	2 Rack	N0777743
4 DX prepFAST System Optima	4 Rack	N0777744
2 DX prepFAST System Avio 200	2 Rack	N0790960
4 DX prepFAST System Avio 200	4 Rack	N0790961
2 DX prepFAST System Avio 500	2 Rack	N0810862
4 DX prepFAST System Avio 500	4 Rack	N0810863

8 rack and 14 rack prepFAST Systems are also available

See page 89 for additional ESI DX Autosamplers

Inductively Coupled Plasma-MS

PerkinElmer offers a wide selection of superior quality products designed to work with your PerkinElmer instruments. Our precision designed products deliver the peace of mind that comes from knowing that you'll get the results you need.

Quick Reference Index Page

➤ Concentric Nebulizers	68
➤ MicroFlow Nebulizers	70
➤ Nebulizers with Integrated Probes	71
➤ GemClean Nebulizers	72
➤ Nebulizer Cleaners	72
➤ Humidifiers	72
➤ Baffled Cyclonic Spray Chambers	73
➤ Scott Spray Chambers	74
➤ Temperature Controlled Spray Chambers	75
➤ Injectors	77
➤ Load Coils	78
➤ Torches	79
➤ Sample Introduction Kits	80
➤ Detectors	82
➤ Cones	83
➤ Consumable Kits	84
➤ FAST High Productivity Systems	87
➤ prepFAST Autodilution and Autocalibration Systems	87

Nebulizers

PerkinElmer offers a complete selection of Nebulizers in a variety of materials for all of your application needs.



Choose from Concentric, MicroFlow and GemClean Nebulizers.

[VIEW PAGE](#)

Spray Chambers

The spray chamber is an integral part of the sample introduction System. Each type of spray chamber has been tested to provide the best performance and analytical results.



Choose from Baffled Cyclonic, Scott Spray and PFA Spray Chambers.

[VIEW PAGE](#)

Injectors

PerkinElmer offers a complete selection of Injectors in various sizes and materials to meet all of your application needs.



Choose from Quartz and Sapphire Injectors.

[VIEW PAGE](#)

Torches

PerkinElmer carefully selects the best materials which provide optimal performance. Torches are specifically designed for your instrument. Trust the consumables engineered for your instruments.



Choose from Demountable Quartz, D-Torch, and Integrated Torch/Injectors.

[VIEW PAGE](#)

Cones

PerkinElmer Cones are precision-designed and manufactured providing the best analytical results. Large-orifice sampler and skimmer cones provide superior long-term stability and resist clogging, allowing analysis under both high and low sample-uptake conditions.



Choose from Nickel and Platinum Cones.

[VIEW PAGE](#)

[TABLE OF CONTENTS](#)

[ORDER ONLINE](#)

[CLICK THE ARROWS TO VIEW EACH PAGE](#)

ANY MATRIX
ANY INTERFERENCE
ANY PARTICLE SIZE



NexION 2000 ICP Mass Spectrometer



NexION 2000 ICP-MS: Triple quad power meets single quad versatility.

Trace metals in food, nanomaterials in water, impurities in everything from pills to electronic components: These are the sweet spot for the NexION® 2000 ICP-MS. Its sample introduction technology lets you run samples with up to 35% total dissolved solids. Plus, its interference removal capabilities give you the best detection limits for your application. And it delivers superior analysis times and single particle/cell detection capability – at least 10x faster than competitive systems. So the NexION 2000 ICP-MS is up to the most important challenge of all: *Yours.*

For more information, visit perkinelmer.com/NexION2000



Concentric Nebulizers

MEINHARD Plus Nebulizers

MEINHARD® Plus Nebulizers have the lowest dead volume of any glass or quartz nebulizer. The low dead volume and high sensitivity provide excellent detection limits and washout.



Each nebulizer comes with the FitKit+ gas and sample quick connect fittings. The connections are made with high-purity PFA, minimizing the chance of contamination during backflow events. The gas connection fits snugly over the maria on the sidearm of the nebulizer.

- Self aspiration rate 0.5 mL/min with argon flow 1 L/min at 50 PSI (3.4 bar/345 kPa)
- Peristaltic pumped rate 0.5 mL/min to 1.0 mL/min
- Includes FG Gas Quick Connect (PFA) and F2 Quick Connect with 0.5 mm ID (orange marker) capillary, 70 cm

Type	ICP-MS Model	Material	Uptake Rate	Part No.
CT R +	NexION 1000/2000	Glass	0.5 mL/min	N8152373
CT Q +	NexION 1000/2000	Quartz	0.5 mL/min	N8152372
CT SilQ +	NexION 1000/2000	Ultra-High Purity Quartz	0.5 mL/min	N8152384
SilQ+	NexION 300/350	Ultra-High Purity Quartz	0.5 mL/min	N8122460
TQ+	NexION 300/350	Quartz	0.5 mL/min	N8122461
TR+	NexION 300/350	Glass	0.5 mL/min	N8122462

Includes FG Gas Quick Connect (**N8121036**) and F2 Quick Connect (**N8121039**) with 0.5 mm ID (orange marker) capillary, 70 cm

MEINHARD® Nebulizers

The MEINHARD Concentric Nebulizer reflects exacting standards in design and manufacturing. Its advantages include simplicity of design and operation, reproducible and self-aligning aerosol and close fabrication control. They provide excellent sensitivity and precision for aqueous solutions and samples with few dissolved solids (less than 1%). MEINHARD Nebulizers are self-aspirating and not to be used with solutions containing hydrofluoric acid. Nebulizers require an end cap (**N0680504**) for use with Scott Spray Chambers.















Type	ICP-MS Model	Material	Uptake Rate	Part No.
Type A0.5	NexION 300/350	Quartz	0.5 mL/min	N8145011
Type C0.5	NexION 300/350	Glass	0.5 mL/min	N8145012
Type C3	ELAN/NexION 300/350	Glass	3.0 mL/min	N8102011
Type K3	ELAN/NexION 300/350	Glass	3.0 mL/min	N0681574
Type A3	ELAN/NexION 300/350	Quartz	3.0 mL/min	WE024371

Solution Fitting **N8145016** is not included with MEINHARD nebulizers.

Nebulizer Replacement Parts

Description	Part No.
 Nebulizer Clip for MEINHARD Nebulizers	N0777460
 Nebulizer Liquid Connector Kit 4 mm 4 in. length by 0.020 in. ID x 0.062 in. OD flanged onto female CTFE fitting. Includes one male barb CTFE fitting	N8145016
 Male Barb CTFE Fitting (Part of N8145016)	N8145017
 Female Barb CTFE Fitting (Part of N8145016)	N8145018
 PFA FG Gas Quick Connect	N8121036
 F2 Standard Integrated Capillary (0.5 mm ID Orange 70 cm long)	N8121039
 F0 Encapsulated Micro Tubing (0.25 mm ID Green 70 cm long)	N8121038
 F1 Detachable Capillary (0.80 mm ID Blue 70 cm long)	N8121037
 Spray Chamber Drain Fitting	N8145015
 PTFE Sample Capillary 0.062 OD x 0.020 ID	WE024375
 MEINHARD® Nebulizer Internal Standard Tee	N8152386
 MEINHARD® Plus Nebulizer Fitting for Concentric Nebulizer (N8152378)	N8152387
 MEINHARD® Plus Peripump Union – Male Barb CTFE Fitting	N8152453
 MEINHARD® Plus Peripump Union – Female Barb CTFE Fitting	N8152388
 MEINHARD® Plus Sample Introduction Line for Concentric Nebulizer	N8145503
 MEINHARD® Plus Concentric Nebulizer 6 in. Gas Line	N8152385

FAST Valve Connecting Lines

Description	Part No.
 FAST Valve Connecting Line for ST-Nebulizer, 0.25 mm ID (Green) Attaches to port #3 of the FAST valve, 14 cm	N0777287
 FAST Valve Connecting Line for ST-Nebulizer, 0.5 mm ID (Orange) Attaches to port #3 of the FAST valve, 14 cm	N0777288
 FAST Valve Connecting Line for ST-Nebulizer, 0.3 mm ID (Yellow) with XL Fitting	N0777769
 Internal standard line for P7 valve with XL Fitting, 0.5 mm ID (Orange)	N8145345
 F0 FAST Valve Connecting Line for MEINHARD® Plus Nebulizers, 0.25 mm ID (Green)	N8145461
 F2 FAST Valve Connecting Line for MEINHARD® Plus Nebulizers, 0.25 mm ID (Green)	N8145346
 F0 FAST Valve Connecting Line for MEINHARD® Plus Nebulizers, 0.5 mm ID (Orange)	N8145462
 F2 FAST Valve Connecting Line for MEINHARD® Plus Nebulizers, 0.5 mm ID (Orange)	N8145347
 FAST Valve Connecting Line for PerkinElmer Gem Cone Nebulizer, 0.50 mm ID (Orange)	N0777659
 FAST Valve Connecting Line for PerkinElmer Gem Cone Nebulizer, 1.00 mm ID (Gray)	N0777661
 FAST Valve Connecting Line for MIRA MIST Nebulizer, 0.50 mm ID (Orange)	N0777658
 FAST Valve Connecting Line for MIRA MIST Nebulizer, 1 mm ID (Gray)	N0777660

MicroMist Nebulizers

The MicroMist micro-uptake glass concentric nebulizer offers high performance for limited sample volumes. MicroMists for ELAN/NexION 300/350 are fitted with a UniFit connector with 1.3 OD X 0.50 mm ID x 700 mm long sample tubing. MicroMists for NexION 1000/2000 Direct Connection (DC) Nebulizers are fitted with a UniFit connector and an Argon connector. All NexION 1000/2000 MicroMist Nebulizers include a Gas Fitting with ratchet connector (**N8151079**).



NexION 1000/2000 DC Nebulizer

ICP-MS Model	Uptake Rate	Part No.
ELAN/NexION 300/350	0.05 mL/min	N0775344
ELAN/NexION 300/350	0.1 mL/min	N0775343
ELAN/NexION 300/350	0.2 mL/min	N0775342
ELAN/NexION 300/350	0.4 mL/min	N0775341
NexION 1000/2000	0.05 mL/min	N8151076
NexION 1000/2000	0.1 mL/min	N8151075
NexION 1000/2000	0.2 mL/min	N8151074
NexION 1000/2000	0.4 mL/min	N8151073

SeaSpray Nebulizers

The SeaSpray Concentric Nebulizer is ideal for samples with high dissolved solids and offers outstanding nebulization efficiency for trace level analysis. It offers freedom from clogging while nebulizing solutions near the limit of solubility of most mineral salts and conferring significant sensitivity gains. All SeaSpray Nebulizers are supplied with the EzyLok Argon connector. All NexION 1000/2000 SeaSpray Nebulizers are Direct Connection (DC) and include a Gas Fitting with ratchet connector (**N8151079**).

ICP-MS Model	Uptake Rate	Part No.
ELAN/NexION 300/350	0.4 mL/min	N0777484
ELAN/NexION 300/350	1 mL/min Quartz	N0774069
ELAN/NexION 300/350	2 mL/min	N0775340
NexION 1000/2000	0.4 mL/min	N8151070
NexION 1000/2000	1.0 mL/min Quartz	N8151072
NexION 1000/2000	2.0 mL/min	N8151071

DuraMist Nebulizers

The DuraMist concentric nebulizer is an economical nebulizer for high precision analyses involving samples digested in HF. The DuraMist nebulizer is recommended for samples containing up to 5% HF. For samples with higher concentrations of HF, the OpalMist PFA nebulizer is recommended.



ICP-MS Model	Uptake Rate	Part No.
ELAN/NexION 300/350	0.4 mL/min	N8121046
ELAN/NexION 300/350	1.0 mL/min	N8121045
NexION 1000/2000	0.4 mL/min	N8151077
NexION 1000/2000	1.0 mL/min	N8151078

OpalMist Nebulizers

The OpalMist is ideal for the geochemistry and semiconductor industry. Ideal for high precision analyses involving analyses requiring high chemical resistancy to HF, alkalis and organics. It also provides excellent results for trace analyses.



ICP-MS Model	Uptake Rate	Part No.
ELAN/NexION 300/350	0.4 mL/min	N0777485
ELAN/NexION 300/350	0.1 mL/min	N0777486
ELAN/NexION 300/350	0.2 mL/min	N8121056
ELAN/NexION 300/350	0.05 mL/min	N8121057
ELAN/NexION 300/350	2 mL/min	N8121061

UniFit Connector



EzyFit Connector



Direct Connection Nebulizer Gas Fitting



Connectors for MicroMist and SeaSpray Nebulizers

Description	Pkg.	Part No.
UniFit		
0.25 mm ID x 1.27 mm OD x 700 mm Long	10	N0777514
0.50 mm ID x 1.27 mm OD x 700 mm Long	10	N0777513
0.75 mm ID x 1.27 mm OD x 700 mm Long	10	N0777512
1.30 mm OD x 0.75 mm ID x 700 mm Long	3	N0774077
1/16 in. OD x 0.75 mm ID x 700 mm Long	3	N0774080
UniFit-EzyFit Sample Tube	6	N0777061
EzyFit		
0.25 mm ID x 1.27 mm OD x 700 mm Long	10	N0777437
0.50 mm ID x 1.27 mm OD x 700 mm Long	10	N0777436
0.75 mm ID x 1.27 mm OD x 700 mm Long	10	N0777435
0.25 mm ID x 1/16 in. OD x 700 mm Long	10	N0777464
0.50 mm ID x 1/16 in. OD x 700 mm Long	10	N0777463
0.50 mm ID x 1/16 in. OD x 700 mm Long Twin	6	N0777462
1/16 in. OD x 0.25 mm ID x 700 mm	10	N0777845
1/16 in. OD x 0.50 mm ID x 700 mm	10	N0777846
1/16 in. OD x 0.75 mm ID x 700 mm	10	N0777847
UniFit-EzyFit Sample Tube	6	N0777061
Direct Connection Nebulizer Gas Fitting		
1/8 Gas Fitting with Ratchet Nebulizer Connector (DC)	1	N8151079

End Cap for Concentric Nebulizers

End cap to fit any concentric nebulizer onto a Scott Spray Chamber.



Description	Part No.
End Cap for Concentric Nebulizers	N0680504

High Efficiency MicroFlow Nebulizers

MicroFlow nebulizers are constructed entirely from chemically resistant fluoropolymers, ideal for strong acids, alkalis, organics, high salt solutions and high solid concentrations. They are resistant to clogging, are reliably self-aspirated or pumped and produce a fine aerosol for high transport efficiency and high sensitivity.

PFA-ST Nebulizer

The PFA-ST nebulizer features high purity, HF-resistance and high performance, along with an exchangeable external sample uptake capillary. The sample uptake rate is controlled by the dimension of the external capillary or probe. Chemically resistant – ideal for strong acids, alkalis, organics. Resistant to clogging – reliably self-aspirated or pumped.



ICP-MS Model	Part No.
ELAN/NexION (Concentric)	N8122192
ELAN/NexION (Self-Aspirating for prepFAST)	N8145368

PFA-ST3 Nebulizer

Designed for superior clog resistance and higher sensitivity. PFA-ST3 nebulizer with external threaded connector is a high performance, clog resistant and chemically inert nebulizer for ICP-MS.



ICP-MS Model	Part No.
ELAN/NexION 300/350	N8145101

PolyPro-ST Nebulizer

The PolyPro-ST Nebulizer is an HF resistant alternative to the PFA nebulizer. The PolyPro has lower chemical resistance than the PFA nebulizer but has the same high efficiency aerosol generation. A robust nebulizer that can self aspirate with an exchangeable external sample uptake capillary or used with a peristaltic pump.



Description	Part No.
PolyPro-ST Nebulizer	N0777220



PFA Nebulizer Replacement Parts

Description	Part No.
Union Fittings for LC to PFA Nebulizer	N8152478
PTFE Connection Line for PFA LC Microflow Nebulizer	N8152479
0.15 mm ST Capillary Line for PFA Microflow Nebulizer	N8152480
PFA Nebulizer Gas Line for PFA-ST Nebulizer	N8145531
Sample Introduction Line for PFA-ST Nebulizer	N8152455
Internal Standard Addition Tee for ST-Nebulizer, 0.25 mm ID (Green). Attaches to port #3, 14 cm	N0777294
Internal Standard Addition Tee for ST-Nebulizer, 0.5 mm ID (Orange). Attaches to port #3, 14 cm	N0777295

apex High Temperature Nebulizers

Description	Part No.
High Temperature apex-ST PFA MicroFlow Nebulizer with External 1/4-28 Threaded Connector	N0777375
High Temperature apex-100 PFA Nebulizer with Integrated 90-150 µL/min Self-Aspiration Capillary	N0777376
High Temperature apex-100 PFA Nebulizer with Uitem Manual Sampling Probe, 90-150 µL/min, 80 cm Capillary	N0777828



PTFE Sample Capillaries

For use with ST Nebulizers.

ID	Self-Aspiration Rate	Part No.
0.15 mm Red	20 µL/min	N8122382
0.2 mm Purple	50 µL/min	N8145135
0.25 mm Green	100 µL/min	N8122383
0.3 mm Yellow	200 µL/min	N8145136
0.5 mm Orange	400 µL/min	N8122384
0.8 mm Blue	700 µL/min	N8145137
1.0 mm Gray	1 mL/min	N8145138



Carbon Fiber Supported Autosampler Probes for ST Nebulizers

Self-aspiration rate @ 1 L/m Ar

Description	Part No.
0.25 mm ID, Capillary Length 80 cm, Self-Aspiration Rate (@ 1 L/m Ar) 100 µL/min	N0777223
0.50 mm ID, Capillary Length 80 cm, Self-Aspiration Rate (@ 1 L/m Ar) 400 µL/min	N0777225
0.25 mm ID, Capillary Length 150 cm, Self-Aspiration Rate (@ 1 L/m Ar) 100 µL/min	N0777826
0.50 mm ID, Capillary Length 150 cm, Self-Aspiration Rate (@ 1 L/m Ar) 100 µL/min	N0777827
Reset Probe Weight Kit. PTFE coated Stainless Steel Weight with Black PEEK Retainer Assembly	N0786043

PTFE Autosampler Probes for ST Nebulizers

Description	Part No.
PTFE Sampling Probe Assembly with Carbon Fiber Support and Female Fitting, 0.25 mm ID for ICP-MS. Requires but does not include N8145017	N8145139
PTFE Sampling Probe Assembly with Carbon Fiber Support and Female Fitting, 0.5 mm ID for ICP/ICP-MS. Requires but does not include N8145017	N8145140
PTFE Internal Standard Probe, 0.5 mm with Carbon Fiber Support with female nut. Connects to standard addition tee or internal standard line	N8145344
PTFE Sampling Probe Assembly with Carbon Fiber Support and Male Screw Fitting, 0.55 mm ID for AA/ICP/ICPMS. For ICP/ICPMS requires but does not include N8145018* . For AA with a stainless steel nebulizer, the male connect should be removed so that tubing can be directly connected to the nebulizer, no additional tubing is required	N2024132

*Keep spare ferrules on hand, **N8145237** Qty. 10



PFA MicroFlow Nebulizers with Integrated Capillaries for NexION 300/350

Measured self-aspiration rate @ 1 L/m Ar

Description	Uptake Rate	Part No.
PFA-20 PFA Nebulizer	20 µL/min	N8122350
PFA-50 PFA Nebulizer	50 µL/min	N8145102
PFA-100 PFA Nebulizer	100 µL/min	N8122351
PFA-200 PFA Nebulizer	200 µL/min	N8145103
PFA-400 PFA Nebulizer	400 µL/min	N8145104

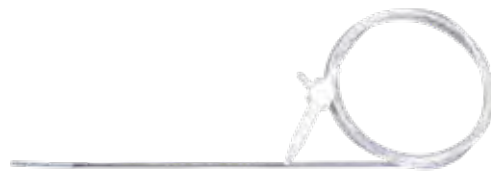

PFA MicroFlow Nebulizers with Integrated Autosampler Probes for NexION 300/350

Measured self-aspiration rate @ 1 L/m Ar

Description	Uptake Rate	Part No.
PFA-20 PFA (Carbon Fiber Support)	20 µL/min, length 80 cm	N0777214
PFA-50 PFA (Carbon Fiber Support)	50 µL/min, length 80 cm	N0777215
PFA-100 PFA (Carbon Fiber Support)	100 µL/min, length 100 cm	N0777216
PFA-200 PFA (Carbon Fiber Support)	200 µL/min, length 100 cm	N0777217
PFA-400 PFA (Carbon Fiber Support)	400 µL/min, length 100 cm	N0777218
PFA-20 PFA (Ultem Support)	20 µL/min, length 100 cm	N8145141
PFA-50 PFA (Ultem Support)	50 µL/min, length 100 cm	N8145142
PFA-100 PFA (Ultem Support)	100 µL/min, length 100 cm	N8145143
PFA-200 PFA (Ultem Support)	200 µL/min, length 100 cm	N8145144
PFA-400 PFA (Ultem Support)	400 µL/min, length 100 cm	N8145275

PFA Nebulizers with Integrated Capillaries for NexION 1000/2000

Measured self-aspiration rate @ 1 L/m Ar

Description	Uptake Rate	Part No.
PFA-20 PFA Nebulizer	20 µL/min	N8152582
PFA-50 PFA Nebulizer	50 µL/min	N8152583
PFA-100 PFA Nebulizer	100 µL/min	N8152584
PFA-200 PFA Nebulizer	200 µL/min	N8152585
PFA-400 PFA Nebulizer	400 µL/min	N8152586

PFA Nebulizers with Integrated Autosampler Probes for NexION 1000/2000

Measured self-aspiration rate @ 1 L/m Ar

Description	Uptake Rate	Part No.
PFA-20 PFA (Carbon Fiber Support)	20 µL/min, length 80 cm	N8152587
PFA-50 PFA (Carbon Fiber Support)	50 µL/min, length 80 cm	N8152588
PFA-100 PFA (Carbon Fiber Support)	100 µL/min, length 100 cm	N8152589
PFA-200 PFA (Carbon Fiber Support)	200 µL/min, length 100 cm	N8152590
PFA-400 PFA (Carbon Fiber Support)	400 µL/min, length 100 cm	N8152591
PFA-20 PFA (Ultem Support)	20 µL/min, length 100 cm	N8152592
PFA-50 PFA (Ultem Support)	50 µL/min, length 100 cm	N8152593
PFA-100 PFA (Ultem Support)	100 µL/min, length 100 cm	N8152594
PFA-200 PFA (Ultem Support)	200 µL/min, length 100 cm	N8152420
PFA-400 PFA (Ultem Support)	400 µL/min, length 100 cm	N8152595

GemClean Nebulizer

GemClean Cross-Flow II Nebulizer

Complete chemically inert Cross-Flow II nebulizer assembly specially processed to reduce BEC levels below 1 ppb. Contains an end cap with a GemTip clear sapphire sample tip and a GemTip red ruby argon tip optimized for ICP-MS.



Description	Part No.
GemClean Cross-Flow II Nebulizer	N8120516

Cross-Flow Replacement GemTips and Spares

Includes a clear sapphire sample tip and a red ruby argon tip optimized for ICP-MS. Tips are constructed of PEEK for maximum corrosion resistance.



Description	Part No.
Cross-Flow II Replacement GemTips	N8120515
Cross-Flow II Nebulizer Argon Ferrule	09920515
Cross-Flow II Nebulizer Ferrule Kit*	N0680612
Cross-Flow II Nebulizer End Cap	N8122239
Cross-Flow II Nebulizer Sample Ferrule	09920518
GemTip II O-Ring	09921045
End Cap O-Ring	09902033
Sample Tubing	09985708
Argon Tubing	09985723

*Includes 09920515 and 09920518

GemClean Cross-Flow II Nebulizer Replacement Parts

Description	Part No.
1 Sample Ferrule – TBG 1/16 Tefzel	09920518
2 Nut – TBG PEEK	09920516
3 Nut	09920517
4 Argon Ferrule – TBG 1/8 Tefzel	09920515
5 O-Ring, 18W, 1 3/8 ID, 1 5/8 OD	09902033
6 Ring	00473543
7 O-Rings (2) 0.126 ID, 0.040 WD, Viton	09921045
8 End Cap Cross-Flow II Nebulizer	N8122239
9 GemTip Kit for Cross-Flow II Nebulizer (Contains one each: Argon and Sample tip)	N8120515
9a Red Ruby Nebulizer, Argon Tip	
9b Clear Nebulizer Sample Tip	
10 Screws (2) – Knurled	00473539

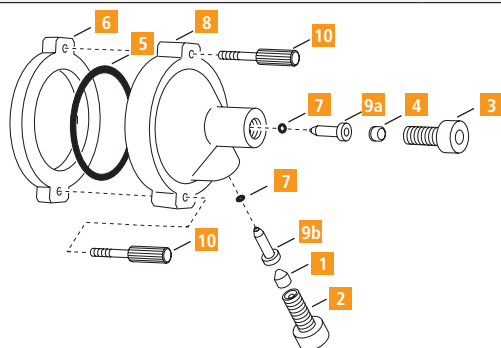

Nebulizer Cleaners

The Eluo™ Nebulizer Cleaner



The Eluo is designated to efficiently deliver a cleanser through the nebulizer capillary to dislodge particle build-up and thoroughly clean the nebulizer.

Description	Part No.
For Newer OpalMist, PolyCon, DuraMist, MEINHARD, Other Glass Nebulizers	N0777712
For OLD Style OpalMist or PolyCon Nebulizers	N0775358

PFA Nebulizer Obstruction Removal Kit



Obstruction Removal Kit while naturally resistant to obstructions, PFA nebulizers may occasionally require maintenance. Use this kit to safely remove obstructions in all PFA-ST nebulizers for long-term high performance.

Description	Part No.
Nebulizer Obstruction Removal Kit	N8145236

Syringe Flush Kit



Use syringe and white adapter to back-flush the carrier line or tee-line. Use syringe and red adapter to forward flush the carrier line, the side port of the tee-line and to forward flush the PFA nebulizer.

Description	Part No.
Syringe Flush Kit Includes 3 mL syringe, two luer to 1/4-28 adapters	N8121035

pergo Argon Humidifier

The *pergo* improves performance of all concentric nebulizers for the routine analysis of brines, fusion digests and other high-TDS samples. *pergo 2* for ICP-MS humidifies both the nebulizer gas flow and the AMS gas flow for optimum performance.



ICP-MS Model	Description	Part No.
ELAN/NexION	<i>pergo 1</i> without Nebulizer	N8145315
ELAN/NexION	<i>pergo 1</i> with MEINHARD Type C Nebulizer	N8145316
ELAN/NexION	<i>pergo 1</i> with PFA-ST Nebulizer	N8150427
ELAN/NexION	<i>pergo 2</i> without Nebulizer	N8150743
ELAN/NexION	<i>pergo 2</i> with MEINHARD Type C Plus Nebulizer	N8150428
ELAN/NexION	<i>pergo 2</i> with PFA-ST Nebulizer	N8150429
NexION 1000/2000	<i>pergo 1</i> NexION 1000/2000 gas line conversion kit	N8152683
NexION 1000/2000	<i>pergo 2</i> NexION 1000/2000 gas line conversion kit	N8152692

Baffled Cyclonic Spray Chambers

The spray chamber is an integral part of the sample introduction system responsible for filtering the sample mist to permit the appropriate droplet size distribution to reach the plasma. The baffled cyclonic spray chamber features a central transfer tube which acts as a secondary particle separator helping separate larger aerosol particles from the sample. This reduces solvent load in the plasma without compromising detection limits. The distance between the bottom of the baffle and the chamber wall is carefully controlled so that droplets cannot form on the bottom of the baffle. The advantage is smooth draining and improved precision.

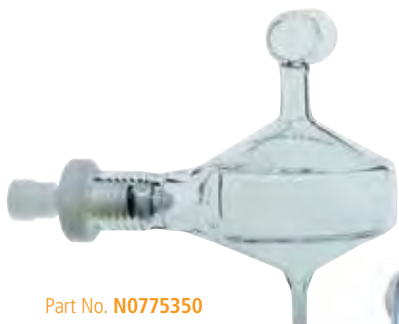

Part No. **N0775350**



Part No. **N8152375**



UV PC³ Light Shield
Part No. **N8152475**

UV Light Shields

ICP-MS Model	Description	Part No.
NexION 1000/2000 ICP-MS 'B' Configuration	UV Light Shield	N8152425
NexION 2000 ICP-MS 'C', 'P' and 'S' Configurations (for use with PC ³)	UV Light Shield	N8152475



High Sensitivity Spray Chamber with Matrix Gas Port
Part No. **N8152389**

Description	Material	Part No.
For NexION 2000 B		
High Sensitivity All-Purpose Spray Chamber for Non-Hf Samples	Glass	N8152375
For NexION 1000 and 2000 C/P		
High Sensitivity Spray Chamber with Matrix Gas Port	Glass	N8152389
For NexION 2000 S		
High Sensitivity All-Purpose Spray Chamber for Non-Hf Samples. Provides Excellent Sensitivity, Stability And Ultra-Low Blanks	SilQ	N8152424
For NexION 1000 and 2000		
High Sensitivity Spray Chamber with Matrix Gas Port for Applications Requiring Low Levels Of Boron and Silicon Detection	Quartz	N8152383
For NexION 300/350		
O-Ring Free Spray Chamber	Quartz	N8145013
For ELAN DRC/DRCplus/DRC II		
Spray Chamber	Quartz	WE025221
For NexION (Standard with NexION 300/350 Q/X/D)*		
Spray Chamber	Glass	N8145014
For ELAN		
Spray Chamber	Glass	N8122188
For ELAN/NexION 300/350		
O-Ring Free Spray Chamber	Glass	N0775350

Asperon™ Spray Chamber



ICP-MS Model	Description	Part No.
NexION 1000/2000	Asperon Spray Chamber	N8152493

See page 129 for
Single Cell Sample Introduction Kits

Spray Chamber Replacement Parts



Part No. **N8141420**



Part No. **N0777438**



Part No. **N0777439**

Description	Part No.
Threaded Spray Chamber Drain Line PTFE 1/4-28	N8152456
Argon Matrix Gas Line for NexION 2000, AMS. For Gas Dilution of High TDS Samples	N8152374
Argon Matrix Gas Line for NexION 300/350. For Gas Dilution of High TDS Samples	N8152720
Addition Gas Line 0.8 mm ID for NexION 2000. Attaches to AMS Spray Chamber Port	N8152426
Addition Gas Line 0.8 mm ID for NexION 2000 47 mm PFA Spray Chamber. Attaches to AMS Spray Chamber Port	N8152449
Cyclonic Spray Chamber Matrix Gas Plug	N8145516
Spray Chamber Nebulizer Port Plug	N8145517
Spray Chamber Outlet Plug	N8145518
Long (6 mm) PFA Spray Chamber Secure Nut	N8145321
Short (6 mm) PFA Spray Chamber Secure Nut	N8141420
Cyclonic Spray Chamber Adapter	N8152551
Helix Locking Screw	N0777438
Helix Seal Pkg. 4	N0777439
O-Ring for Baffled Quartz Cyclonic Spray Chamber	09210011



Part No. **N8120124**



Scott Spray Chambers

Complete HF-resistant Scott Spray Chamber
Includes (1) large O-Ring (**WE013060**), (1) Retaining Ring (**WE014081**) and (1) Right-Angled Drain Connector (**WE013119**).

Description	Part No.
For ELAN 9000/6x00/5000/DRC-e/NexION 300/350	
Scott Spray Chamber	N8120124
Scott Spray Chamber Large O-Ring	WE013060
Scott Spray Chamber Retaining Ring	WE014081
End-Cap for Concentric Nebulizer. Ryton Endcap to Fit Nebulizer onto Scott Spray Chamber	N0680504



Part No. **N8150450**



Part No. **N8142000**

PFA Spray Chambers

ICP-MS Model	Description	Part No.
NexION 1000/2000	PFA Barrel Spray Chamber Double Pass Spray Chamber for use with HF acid	N8152390
NexION 1000/2000	PFA Barrel Spray Chamber with Additional Gas Port Double Pass Spray Chamber for use with HF acid	N8150450
NexION 300/350	PFA Spray Chamber with PFA End Cap*	N8142000
ELAN	PFA PTFE Spray Chamber	N8122356

* Requires PFA body injector **N8122411** or **N8122412** or **N8122413**

PC³ Replacement Spray Chambers



Part No. **N8145120**

NexION O-Ring Free Baffled Cyclonic PC³/PC^{3x} Spray Chambers

Description	Part No.
High Purity Quartz Cyclonic Spray Chamber	N8145120
Micro Cyclonic Spray Chamber	N8145121
Borosilicate Glass Spray Chamber	N8145119
PFA Cyclonic Spray Chamber	N8145122



Part No. **N0777034**

ELAN Baffled Quartz Cyclonic PC³ Spray Chambers

Description	Part No.
With Auxiliary Gas Port	N0777034
Without Auxiliary Gas Port	N0777035

Temperature Controlled Spray Chambers



Part No. **N8145314**



Part No. **N8142003**



Part No. **N8145099**

PC³ Peltier Coolers

The PC³ is a small and robust Peltier cooler for ICP-MS cyclonic spray chambers. The cyclonic spray chamber offers the advantages of low memory effects, fast rinseout and high sample transport efficiency. The PC³ cools the outer walls of the cyclonic spray chamber to a constant temperature, enhancing long-term signal stability, reducing polyatomic interferences such as oxides and reducing solvent loading when volatile organic solvents are analyzed. The PC³ has 2 preset temperatures +2 °C / -5 °C and is ideal for analysis of aqueous or aqueous/organic mixtures. The PC³-LT operates at -20 °C to reduce the solvent load on the plasma for analysis of 100% volatile organic solvents.

Description	Injector Size	Temperature	Additional Gas Port	Part No.
NexION 300/350				
PC ³ Sample Introduction Kit*	1.5 mm	+2 °C / -5 °C	Yes	N8142003
PC ³ Sample Introduction Kit with Quartz SSI Cyclonic/Scott Dual Spray Chamber	1.5 mm	+2 °C / -5 °C	No	N8145314
HF PC ³ Sample Introduction Kit*	1.5 mm	+2 °C / -5 °C	Yes	N8145309
PC ³ -LT Organic Sample Introduction Kit*	1.0 mm	+2 °C / -20 °C	Yes	N8145099
HF PC ³ -LT Organic Sample Introduction Kit*	1.5 mm	+2 °C / -20 °C	Yes	N8145310

* All PC³ kits include a PFA-ST nebulizer (N8122192)



Part No. **N8145340**



Part No. **N8152382**

PC^{3x} Peltier Controlled Heated or Cooled Thermally Stabilized Inlet Systems

The PC^{3x} is a compact Peltier heated or cooled inlet system that controls the spray chamber temperature and improves long-term stability. In cooling mode, water or solvent is removed from the aerosol, reducing water or solvent loading on the plasma. In heating mode, sensitivity is increased and volatility-related sample transport effects can be reduced or eliminated.

- Variable temperature control from -10 °C to +80 °C
- Thermal stabilization of spray chamber improves long-term stability
- USB or Bluetooth connectivity
- Remote monitoring and control

ICP-MS Model	Spray Chamber	Part No.
NexION 1000/2000	Not included	N8152382
NexION 300/350	Quartz	N8145340
NexION 300/350	Quartz	N8145446

PC^{3x} Thermally Stabilized Inlet System

The PC^{3x} for the High Performance PFA spray chamber is a compact, Peltier-heated or cooled inlet system that offers the advantages of low memory effects, constant temperature, rapid wash-out and high sample transport efficiency. In cooling mode the PC^{3x} cools the outer walls of the chamber, reducing the water or solvent vapor loading on the plasma, achieving enhanced stability and performance. In heating mode, sensitivity can be improved for low-flow applications. Includes spray chamber and nebulizer.



ICP-MS Model	Description	Part No.
NexION 1000/2000	Includes PFA Nebulizer and Spray Chamber	N8150446
NexION 1000/2000	Includes PFA Spray Chamber	N8150445

See next page for more
Temperature Controlled Spray Chambers

Temperature Controlled Spray Chambers

PC³ Peltier Coolers

The PC³ is a small and robust Peltier cooler for ICP-MS cyclonic spray chambers. The cyclonic spray chamber offers the advantages of low memory effects, fast rinse-out and high sample transport efficiency. The PC³ cools the outer walls of the cyclonic spray chamber to a constant temperature, enhancing long-term signal stability, reducing polyatomic interferences such as oxides and reducing solvent loading when volatile organic solvents are analyzed. The PC³ has two present temperatures +2 °C / -5 °C and is ideal for analysis of aqueous or aqueous/organic mixtures. The PC³-LT operates at +2 °C / -20 °C to reduce the solvent load on the plasma for analysis of 100% volatile organic solvents.



ICP-MS Model	Description	Part No.
ELAN	Cassette Torch Mount	N8122410
ELAN	Twist Type Torch Mount	N8122389
ELAN	PC3-LT	N8122452

IsoMist Temperature Controlled Spray Chambers

The IsoMist Programmable Temperature Controlled Spray Chamber provides the benefits of a temperature-controlled ICP sample introduction system in a compact, convenient package. The temperature is electronically controlled using a powerful inbuilt Peltier device. The rapid response of the Peltier device allows a spray chamber temperature of -5°C to be reached within 15 minutes.



The IsoMist XR programmable temperature controlled cyclonic spray chamber now features an improved thermodynamic design providing an extended temperature range and faster cool-down, so your ICP is ready to go sooner. IsoMist XR has a peltier unit with a range of -25°C to +80°C.

ICP-MS Model	Description	Part No.
NexION 300/350	IsoMist XR Glass	N8140747
NexION 300/350	IsoMist XR PFA	N8140748
NexION 300/350	IsoMist XR Quartz	N8140749

Sample Introduction Kits

Complete high purity sample introduction system for NexION 300/350.

All wetted surfaces are PTFE and Pt. Used by a majority of semiconductor labs worldwide for the analysis of semiconductor grade chemicals and Si wafer samples.



Description	Part No.
PFA-Platinum HF resistant Sample Introduction Kit Includes: Microflow PFA-100 Nebulizers Qty. 2 (N8122351), 47 mm PFA Spray Chamber, PFA PureCap Endcap (N8122357), Threaded Drain Line (N8141425), 2 mm Pt Cassette Injector with PFA Base (N8122412), Pt Injector Shield Disc (N077366), Quartz Torch (N8122006)	N8142001

Complete HF-resistant sample introduction system for NexION 300/350. All wetted surfaces are PTFE and Sapphire. Provides a chemically inert and clean introduction system.



Description	Part No.
PFA-Sapphire HF-Resistant Sample Introduction Kit Includes: 47 mm PFA Spray Chamber, PFA PureCap Endcap (N8122357), 1.8 mm Sapphire Injector (N8122411), Quartz Torch (N8122006), Platinum Shield Disc (N077366), PFA-ST Nebulizer (N8122192)	N8142002

HF Sample Introduction Kit

Description	Part No.
HF Sample Introduction Kit for NexION 300/350 Includes: Tygon Tubing 0.3 m/per ft. (02506516), PTFE Coated O-Ring 0.239 ID x 0.070 WD (09210011), PTFE Coated O-Ring 0.364 ID x 0.070 WD (09210012), Polyethylene Tubing for AA Neb, 10 ft. (09908265), PVC Black/Black Tubing 0.76 mm ID, Pkg. 12 (09908587), Adapter Kit 1/8x1/8 (09920379), Sapphire Injector 2.0 mm 3000/SCR/3x00 RL (N0695495), Cross-Flow II Nebulizer End Cap ELAN (N8120516), Quartz Torch (N8122006), 3.18 mm ID Black/White PVC Pkg. 12 (N8122012), HF Sample Introduction Kit (N8140507), Spray Chamber Kit Etched (N8140511), Injector Nut (W1012408), Injector Spacer (W1012409), Torch Spacer (W1012410), Cassette Torch Mount Adapter (W1013266), PTFE O-Ring 5/8 in. ID x 1/8 in. Wide (W1013545), Scott Spray Chamber Adapter (W1024879)	N8140507

Injectors



Part No. **N8125029**



Part No. **N8152444**



Part No. **N8122412**

Quartz Injectors

ICP-MS Model	Dimensions	Part No.
For use when using the HF-Resistant Sample Introduction System (WE024782)		
ELAN/NexION 300/350	1.2 mm ID	N0681631
ELAN/NexION 300/350	1.6 mm ID	00473292
ELAN/NexION 300/350	2.0 mm ID	N8125029



Part No. **WE023948**

Quartz Ball Joint Injectors

ICP-MS Model	Dimensions	Part No.
For use with Pass-Through Ball Joint Injector Support Adapters (WE023951 or W1012406)		
ELAN/NexION 300/350	0.85 mm ID*	WE027030
ELAN/NexION 300/350	1.5 mm ID*	WE027005
ELAN/NexION 300/350	2.0 mm ID	WE023948

*For reduced sample loading



Part No. **N0695495**

Sapphire Injector

Demountable injector for use with the HF-resistant sample introduction system. Not for use with PFA sample introduction system.

ICP-MS Model	Dimensions	Part No.
ELAN/NexION 300/350	2.0 mm	N0695495

Torch Injector Replacement Parts for NexION 1000/2000

Description	Part No.
Torch Injector Nut	N8152451
Torch Injector Nut Removal Tool	N8152443
Torch O-Ring Kit Viton O-Ring Kit Includes 2.8 mm ID (Qty. 4), 14 mm ID (Qty. 1) and 16 mm ID (Qty. 1)	N8152476

Injectors for Demountable Torches

Description	Dimensions	Part No.
NexION 1000/2000		
Quartz (Black/Orange/Orange)	1.0 mm	N8152444
Quartz (Black/Orange)	1.5 mm	N8152445
Quartz (Black)	2.0 mm	N8152376
Quartz (Black/Green)	2.5 mm	N8152446
Sapphire (Black/Gold/Gold)	1.5 mm	N8152606
Sapphire (Black/Gold)	2.0 mm	N8152447
Platinum (Gray/Gray/Gray)	1.0 mm	N8152603
Platinum (Gray/Gray)	1.5 mm	N8152604
Platinum (Gray)	2.0 mm	N8152429
NexION 300/350		
Quartz	1.0 mm	N0777410
Quartz	1.5 mm	N8122413
Quartz	2.0 mm	N0777457
Quartz	2.5 mm	N8145118
Quartz (O-Ring Free)	1.0 mm	N8145114
Quartz (O-Ring Free High TDS)	1.0 mm	N8145117
Quartz (O-Ring Free)	1.5 mm	N8145115
Quartz (O-Ring Free)	2.0 mm	N8145116
Sapphire	1.6 mm	N8145112
Sapphire	1.8 mm	N8122411
Sapphire	2.5 mm	N8145338
Sapphire (O-Ring Free)	1.5 mm	N8145113
Sapphire (O-Ring Free)	1.6 mm	N8145072
Sapphire (O-Ring Free)	2.5 mm	N8145339
Platinum	1.0 mm	N8145107
Platinum	1.5 mm	N8145108
Platinum	2.0 mm	N8122412
Platinum (O-Ring Free)	1.0 mm	N8145109
Platinum (O-Ring Free)	1.5 mm	N8145110
Platinum (O-Ring Free)	2.0 mm	N8145111

Injector Assemblies and Support Adapters can be found on the next page

Injector Assemblies and Support Adapters



Part No. **N8122358**

PFA Injector Assemblies

Description	Recommended Use	Part No.
PFA/Quartz Torch Injector Assembly		
PFA/Quartz Twist Type	1.5 mm ID	N8122394
PFA/Quartz Cassette	1.5 mm ID	N8122413
PFA/Sapphire Torch Injector Assembly		
PFA/Sapphire Twist Type	1.8 mm ID	N8122358
PFA/Sapphire Cassette	1.8 mm ID	N8122411
PFA/Platinum Torch Injector Assembly		
PFA/Platinum Twist Type	2.0 mm ID	N8122359
PFA/Platinum Cassette	2.0 mm ID	N8122412



Part No. **W1012406**



Part No. **N8122007**



Part No. **WE023951**

Injector Support Adapters

ICP-MS Model	Part No.
ELAN DRC/DRCplus/DRC II	
Ball Joint Twist Type Torch Injector Support Adapter	WE023951
ELAN DRC II	
Ball Joint Cassette Torch Injector Support Adapter	W1012406
ELAN 9000/6x00/5000/DRC-e	
Twist Type Torch Injector Support Adapter	N8122007
Twist Type Torch Injector Support Adapter (Assembled with O-Rings)	N8120116
ELAN 9000/6x00/5000/DRCs/NexION 300/350	
Injector Support Adapter O-Ring Kit	N8120100
Cassette Torch Injector Support Adapter For Non-Ball Joint Injectors	W1013266
Ball Joint Cassette Torch Injector Support Adapter	W1012406

Injector Support Adapter O-Rings

Position	Torch Type	Part No.
Internal	Twist/Cassette	09210011
External (Large)	Cassette	W1013545
External	Twist/Cassette	09210012
Internal	Cassette (Non-Ball Joint Only)	N8122010
Internal	Twist (Non-Ball Joint)	WE013060

Injector Adapter Kits and O-Rings

Description	Qty.	Part No.
For NexION 300/350 Injector Adapter Kit		
Kit Includes:		N8140360
Adapter	1	W1012406
O-Ring 3/8 in. ID x 1/16 in.	1	W1008572
O-Ring 1/4 in. ID x 1/16 in.	1	W1008573
Injector Spacer	1	W1012409
Injector Nut	1	W1012408
For NexION 300/350 Injector Adapter Kit 2		
Kit Includes:		N8140527
Injector O-Ring 0.239 ID x 0.070 WD	1	09210011
O-Ring 0.551 ID x 0.070 WD	1	N8122010
O-Ring 3/8 in. ID x 1/16 in.	1	W1008572
Adapter	1	W1012406
Injector Nut	1	W1012408
Injector Spacer	1	W1012409
O-Ring 5/8 in. ID x 1/8 in. WD	1	W1013545
For ELAN Cassette O-Ring Kit for Injector Support		
Kit Includes:		N8120100
Injector O-Ring 0.239 ID x 0.070 WD	2	09210011
Torch O-Ring 0.364 ID x 0.070 WD	2	09210012
O-Ring 0.551 ID x 0.070 WD	1	N8122010
O-Ring 5/8 in. ID x 1/8 in. WD	1	W1013545

Load Coils



LumiCoil™ Plasma Load Coil

ICP-MS Model	Part No.
NexION 1000/2000	N8150279

RF Load Coil Assemblies

ICP-MS Model	Part No.
ELAN 9000/6x00/DRCs/NexION 300/350	WE021816
ELAN 5000	WE012411



Torches



Part No. **N8152473**

Demountable and Fixed Quartz Torches

The one-piece quartz torch has the injector integrated directly into the torch.

Torch	Description	Part No.
NexION 1000/2000		
Demountable Quartz Torch (Black)	Demountable Quartz Torch, PVDF O-Ring Free Holder for Demountable Injectors	N8152379
Demountable UHP Quartz Torch (Gray)	Demountable Ultra Pure Quartz Torch, PVDF O-Ring Free Holder for Demountable Injectors	N8152448
Demountable Quartz Torch (Organics)	Demountable Quartz Torch for Organic Analysis	N8152596
Fixed 2.0 mm Injector UHP Quartz Torch (White)	One Piece Ultra Pure Quartz Torch with 2.0 mm Injector, PVDF O-Ring Free Holder for 'S' Configuration	N8152428
Fixed 2.0 mm Injector Quartz Torch (Blue/Purple)	One Piece Quartz Torch with 2.0 mm Injector, PVDF O-Ring Free Holder for 'B' Configuration	N8152472
Fixed 2.5 mm Injector Quartz Torch (Green)	One Piece Quartz Torch with 2.5 mm Injector, PVDF O-Ring Free Holder for 'C' Configuration	N8152473
Fixed 1.5 mm Injector Quartz Torch (Blue/Blue)	One Piece Quartz Torch with 1.5 mm Injector, PVDF O-Ring Free Holder	N8152427
Fixed 1.5 mm Injector Quartz Torch (Orange)	One Piece Quartz Torch with 1.5 mm Injector, PVDF O-Ring Free Holder for Organic Solvents	N8152616
Fixed 1.5 mm Injector UHP Quartz Torch (White/White)	One Piece Ultra Pure Quartz Torch with 1.0 mm Injector, PVDF O-Ring Free Holder	N8152601
Fixed 1.0 mm Injector Quartz Torch (Orange/Orange)	One Piece Quartz Torch with 1.0 mm Injector, PVDF O-Ring Free Holder for High Volatility Organic Solvents	N8152474
Fixed 1.0 mm Injector Quartz Torch (Blue/Blue/Blue)	One Piece Quartz Torch with 1.0 mm Injector, PVDF O-Ring Free Holder	N8152699
Fixed 1.0 mm Injector UHP Quartz Torch (White/White/White)	One Piece Ultra Pure Quartz Torch with 1.0 mm Injector, PVDF O-Ring Free Holder	N8152600
Torch Injector Nut		N8152451
Torch Injector Nut Removal Tool		N8152443
Torch O-Ring Kit for Torch Cassette	Viton O-Ring Kit Includes: 2.8 mm ID (Qty. 4), 14 mm ID (Qty. 1) and 16 mm ID (Qty. 1)	N8152476

Demountable Quartz Torch

ICP-MS Model	Part No.
ELAN/NexION 300/350	N8122006
ELAN (Organics)/NexION 300/350	N8141315
ELAN/NexION 300/350 (O-Ring Free for ESI Injectors)	N8145106

High Efficiency Demountable Quartz Torch

ICP-MS Model	Part No.
NexION 300/350	N8145318
ELAN 9000/6x00/DRCs	W1008384

D-Torch

Demountable Torch

The D-Torch™ provides a demountable torch design without sacrificing performance or usability. Featuring a torch body with fixed alumina intermediate tube for greater robustness, in addition to a demountable outer tube and injector, the D-Torch significantly reduces torch replacement costs for the analysis of challenging sample matrices.



Part No. **N0777419**



Part No. **N0777415**



Part No. **N0777417**

Description	Part No.
For ELAN/NexION 300/350	
D-Torch Complete with Quartz Outer Tube	N0777419
D-Torch Complete with Ceramic Outer Tube	N0777415
Base and Inner Tube	N0777416
Ceramic Outer Tube	N0777417
Quartz Outer Tube	N0777420
Retaining Ring	N0777055



Torch Alignment Tool

Used to align the torch in the load coil.

ICP-MS Model	Part No.
NexION 1000/2000	N8157042
ELAN 9000/6x00/DRCs/NexION 300/350	WE015554







Cassette Torch Mount

ICP-MS Model	Part No.
NexION 300/350	W1037485
ELAN DRC II	W1020672
ELAN 9000/DRC-e	W1020668

Does not include Demountable Quartz Torch or Injector.

Sample Introduction Kits for NexION 1000/2000

NexION 2000 SMARTintro sample introduction solutions are tested as a complete unit to ensure intra- and inter-laboratory performance. Each system utilizes specific combinations of sample introduction components and the kits are color-coded according to the application of the user.

SMARTintro Sample Introduction Kit	Description	Part No.
	PFA-Platinum HF-Resistant Sample Introduction Kit Kit Includes: PFA Spray Chamber with PFA End Cap (N8150450), Cyclonic Spray Chamber Adapter (N8152551), Demountable SilQ Torch (N8152448), Platinum 2 mm Injector (N8152429), Plasma Light Shield (N8152377), Cassette Only Platinum (N8152434), Gas Line Addition (N8152449), Spray Chamber Drain Line 1/4-28 Fitting (N8152456), PFA-200 PFA MicroFlow Nebulizer (N8152420), Torch Injector Nut Removal Tool (N8152443), Torch Injector Nut (N8152451)	N8150033
	Organics Sample Introduction Kit (Orange) Kit Includes: Quartz Nebulizer Type C (N8152372), Cyclonic Quartz Spray Chamber (N8152383), Quartz 1.5 mm Organics Torch One-Piece (N8152616), MEINHARD Nebulizer Sample Line (N8145503), Plasma Light Shield (N8152377), MEINHARD Internal Standard Nebulizer Tee (N8152386), Spray Chamber Light Shield (N8152425), Gas Line Addition (N8152426), Cassette Only Orange (N8152435), Torch Injector Nut Removal Tool (N8152443), Torch Injector Nut (N8152451), Internal Standard Probe Qty. 2 (N8152452), PeriPump Union Male Fitting (N8152453), Spray Chamber Drain Line 1/4-28 Fitting (N8152456)	N8150031
	Geological Sample Introduction Kit (Gold) Kit Includes: PeriPump Tubing Starter Kit (N8150060), PFA Spray Chamber with PFA End Cap (N8150450), Plasma Light Shield (N8152377), PFA Nebulizer (N8152378), Quartz Torch (N8152379), Internal Standard Addition Tee for PFA-ST Nebulizer (N8152423), Torch Injector Nut Removal Tool (N8152443), Sapphire 2 mm Injector (N8152447), Gas Line Addition (N8152449), Torch Injector Nut (N8152451), Internal Standard Probe Qty. 2 (N8152452), Sample Introduction Line for PFA-ST Nebulizer (N8152455), Spray Chamber Drain Line 1/4-28 Fitting (N8152456), PC ³ Spray Chamber Light Shield (N8152475), Cassette Only Gold (N8152532)	N8150040
	Sample Introduction Kit for NexION 1000 ICP-MS (Purple) Kit Includes: MEINHARD Nebulizer Sample Line (N8145503), PeriPump Tubing Starter Kit (N8150060), Glass Nebulizer Type C (N8152373), Matrix Gas Line 9 in. (N8152374), Plasma Light Shield (N8152377), Glass Cyclonic C3 High Sensitivity Spray Chamber with Matrix Port (N8152389), Spray Chamber Light Shield (N8152425), Torch Injector Nut Removal Tool (N8152443), Torch Injector Nut (N8152451), Internal Standard Probe Qty. 2 (N8152452), PeriPump Union Male Fitting (N8152453), Spray Chamber Drain Line 1/4-28 Fitting (N8152456), One Piece 2.0 mm Quartz Torch (N8152472), Cassette Only Purple (N8152533)	N8150038
	Sample Introduction Kit for NexION 2000 Base Configuration (Blue) Kit Includes: Glass Nebulizer Type C (N8152373), Glass Cyclonic Spray Chamber (N8152375), One Piece 2.0 mm Quartz Torch (N8152472), MEINHARD Nebulizer Sample Line (N8145503), PeriPump Tubing Starter Kit (N8150060), Plasma Light Shield (N8152377), MEINHARD Internal Standard Nebulizer Tee (N8152386), Spray Chamber Light Shield (N8152425), Cassette Only Blue (N8152430), Torch Injector Nut Removal Tool (N8152443), Internal Standard Probe Qty. 2 (N8152452), PeriPump Union Male Fitting (N8152453), Spray Chamber Drain Line 1/4-28 Fitting (N8152456), Torch Injector Nut (N8152451)	N8150034
	Sample Introduction Kit for NexION 2000 Core Configuration (Green) Kit Includes: Glass Nebulizer Type C (N8152373), Glass Cyclonic C3 High Sensitivity Spray Chamber with Matrix Port (N8152389), Quartz Torch (N8152473), MEINHARD Nebulizer Sample Line (N8145503), PeriPump Tubing Starter Kit (N8150060), Matrix Gas Line 9 in. (N8152374), Plasma Light Shield (N8152377), PC3 Peltier Cooler (N8152382), MEINHARD Internal Standard Nebulizer Tee (N8152386), Spray Chamber Light Shield (N8152425), Cassette Only Green (N8152431), Torch Injector Nut Removal Tool (N8152443), Internal Standard Probe Qty. 2 (N8152452), PeriPump Union Male Fitting (N8152453), Spray Chamber Drain Line 1/4-28 Fitting (N8152456), PC ³ Spray Chamber Light Shield (N8152475), Torch Injector Nut (N8152451)	N8150035

SMARTintro Sample Introduction Kit	Description	Part No.
	Sample Introduction Kit for NexION 2000 Productivity Configuration (Black) Kit Includes:	N8150036
	PFA Nebulizer (N8152378), Quartz Torch (N8152379), Glass Cyclonic C3 High Sensitivity Spray Chamber with Matrix Port (N8152389), Cyclonic Peltier Cooler (N8152382), CTFE Liquid Fitting Female (N8145018), FAST 1 Valve (N8152359), MP ² Micro Peristaltic Pump with Single FAST Valve (N8152364), Matrix Gas Line 9 in. (N8152374), 2 mm Demountable Quartz Injector (N8152376), Plasma Light Shield (N8152377), FAST Pump Tubing Starter Kit (N8152380), Spray Chamber Light Shield (N8152425), Cassette Only Black (N8152433), Torch Injector Nut Removal Tool (N8152443), PFA-ST Nebulizer Sample Introduction Line (N8152455), Spray Chamber Drain Line 1/4-28 Fitting (N8152456), Spray Chamber Light Shield (N8152475), Nuts/Ferrules 1/4-28 for HF Valve Qty.10 (N0777283), Sample Loop for Ports 1 and 4, 0.5 mL (N0777289), HF Ferrule/Nut Set, 1/4-28 Qty.10 (N0777297), 0.8 mm ID Sample Loop PTFE, 300 µL (N0777430), 2 mL Sample Loop (N0777479), 4 mL Sample Loop (N0777480), 1 mL Loop 1 mm ID (N0777664), 1.5 mL Loop 1 mm ID (N0777665), 0.5 mL Loop 1 mm ID (N0777666), L 3 mL Loop 1 mm ID (N0777667), Holder with FAST Bottles (N0777777), RS485 Serial Cable – Power/Communication (N2024191), CTFE Female Barb Fitting (N8145018), Waste Line for SC-FAST (N8145536), FAST 1 Valve with P7 (N8152359), Torch Injector Nut (N8152451)	
	Sample Introduction Kit for NexION 2000 Semi-Conductor Configuration (White) Kit Includes:	N8150037
	PFA Nebulizer (N8152378), Quartz SiIQ Spray Chamber (N8152424), Quartz Fixed Torch (N8152428), Cyclonic Peltier Cooler (N8152382), CTFE Liquid Fitting Female (N8145018), PeriPump Tubing Starter Kit (N8150060), Plasma Light Shield (N8152377), Internal Standard Addition Tee for PFA ST Nebulizer (N8152423), Cassette Only White (N8152432), Torch Injector Nut Removal Tool (N8152443), Internal Standard Probe Qty. 2 (N8152452), PFA-ST Nebulizer Sample Introduction Line (N8152455), Spray Chamber Drain Line 1/4-28 Fitting (N8152456), Spray Chamber Light Shield (N8152475)	

SMARTintro Sample Introduction Modules and Cassettes

SMARTintro Sample Introduction Modules and Cassettes include Cassettes, Torch, PTFE Torch Light Shield and Torch Injector Removal Tool.

	Description	Part No.
	Blue Colored Cassette, One-Piece Quartz Torch, 2.0 mm Quartz Injector	N8152437
	Green Colored Cassette, One-Piece Quartz Torch, 2.5 mm Quartz Injector	N8152438
	White Colored Cassette, One-Piece SiIQ Torch, 2.0 mm Quartz Injector	N8152439
	Black Colored Cassette, Demountable Quartz Torch, 2.0 mm Quartz Injector	N8152440
	Purple Colored Cassette, One-piece Quartz Torch, 2.0 mm Quartz Injector	N8152536
	Platinum Colored Cassette, Demountable Quartz Torch, 2.0 mm Platinum Injector	N8152441
	Orange Colored Cassette, One-Piece Quartz Torch, 1.5 mm Quartz Injector	N8152442
	Gold Colored Cassette, One-Piece Quartz Torch, 2.0 mm Quartz Injector	N8152535

Sample Introduction Cassettes Only

	Color	Part No.
	Blue (Included with NexION 2000 ICP-MS Base 'B' Configuration)	N8152430
	Green (Included with NexION 2000 ICP-MS Core 'C' Configuration)	N8152431
	White (Included with NexION 2000 ICP-MS High Purity 'S' Configuration)	N8152432
	Black (Included with NexION 2000 ICP-MS Productivity 'P' Configuration)	N8152433
	Purple (included with NexION 1000 ICP-MS)	N8152533
	Platinum (High Purity/HF Resistant)	N8152434
	Orange (Organic Solvents)	N8152435
	Gold (For Geological Samples)	N8152532

Mass Spectrometer Hardware



Part No. **N8145027**



Part No. **N8145000**

SimulScan Dual-Stage Detector

The dual -stage detector is an integral part of the NexION ICP-MS SimulScan™ system. This discrete dynode electron multiplier measures both high- and low-level analytes simultaneously. This conserves valuable or limited samples eliminates the need to perform time-consuming sample dilutions and allows you to quickly characterize unknown samples.

ICP-MS Model	Part No.
NexION 350/1000/2000*	N8145027
NexION 300/350**	N8145000

* Service installation is required, but not included.

**Not compatible with NexION 350 shipped after March 1, 2016

Original SimulScan Dual-Stage Detector

The original dual-stage detector is an integral part of the ELAN SimulScan™ system. This electron multiplier measures both high- and low-level analytes simultaneously. This conserves valuable or limited samples, eliminates the need to perform time-consuming sample dilutions and allows you to quickly characterize unknown samples.



ICP-MS Model	Part No.
ELAN 9000/6x00/DRCs* Manufactured Prior to April, 2005	N8125001

Improved SimulScan Dual-Stage Detector

ELAN instruments produced after April, 2005 have the proper electronics to accept this detector without modification. ELAN instruments manufactured before April, 2005 will require a one-time upgrade to the Detector Electronics (**W1013195**). Using this detector in an instrument without the upgraded electronics will result in higher noise levels and shorter lifetime.



ICP-MS Model	Part No.
ELAN 9000/6x00/DRCs*	N8125050

Detector Electronics Upgrade Kit

Boosts detector life at least 20%.

ICP-MS Model	Part No.
ELAN 9000/6x00/DRCs* Manufactured Prior to April, 2005	W1013195

* Service installation is required, but not included.

Ion Optics

PerkinElmer offers the industry's only single-ion lens with the exclusive SwiftMount™ II cassette lens mount. No tools are required as the design incorporates a clean capture-and-release concept.

Ion Lens

Description	ICP-MS Model	Part No.
Cassette Ion Lens Upgrade Kit	ELANs Manufactured Before April, 2005	W1017871
Series II Ion Lens	ELAN 9000/6x00/DRCs Manufactured After January, 1998	WE018034
Ion Lens	ELAN 6000s Manufactured Before January, 1998	WE014777
Series II Lens Removal Tool	ELAN 9000/6x00/DRCs Manufactured Between January, 1998 and April, 2005	W1010620

Series II Ion Lens



Series II ShadowStop

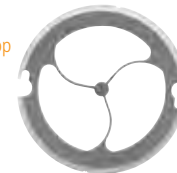

ShadowStop

Description	ICP-MS Model	Part No.
Cassette Lens ShadowStop	ELAN 9000/DRCs Manufactured After April, 2005	W1013361
Series II ShadowStop	ELAN 9000/6X00/DRCs Manufactured Between January, 1998 and April, 2005	WE029011

Vacuum Pump Fluid for ELAN

For use with roughing pumps.

Pump Model	Part No.
Leybold	N8122004
Varian	N8122308

Vacuum Pump Fluid for NexION

For use with NexION ICP-MS only. 1 L Fomblin GV80 fluid (perfluoro polyether). 1 L required per pump.

Description	Part No.
NexION Vacuum Pump Fluid	N8145003

High Vacuum Silicon Grease

For lubrication of vacuum system O-Rings.

Description	Part No.
High Vacuum Silicon Grease	09905147

Cones and Accessories

Sampler and Skimmer Cones

Precision-designed and manufactured, large-orifice sampler and skimmer cones provide superior long-term stability and resist clogging, allowing analysis under both high and low sample-uptake conditions. Nickel is a very rugged, long-lasting material for the majority of sample types, while platinum is the material of choice for more corrosive samples. They have been designed to maximize signal stability and to minimize clogging during extended runs of samples containing high dissolved solids.

Nickel Sampler and Skimmer Cones

ICP-MS Model	Type	Part No.
NexION	Sampler	W1033612
NexION	Skimmer	W1026356
ELAN 9000/6x00/DRC	Sampler	WE021140
ELAN 9000/6x00/DRC	Skimmer	WE021137
NexION	Sampler Gasket	W1040148



NexION Cones



ELAN Cones

Platinum Sampler and Skimmer Cones*

ICP-MS Model	Type	Part No.
NexION	Sampler	W1033614
NexION	Sampler for Sulfur Based Acids/Solvents (18 mm)	N8145028
NexION	Skimmer	W1026907
NexION	Sampler Gasket	W1040148
ELAN 9000/6x00/DRC	Sampler	WE027802
ELAN 9000/6x00/DRC	Skimmer	WE027803

* Prices subject to change based on volatile precious metal prices.



Cone Removal Tool

ICP-MS Model	Part No.
NexION	W1034694
ELAN 9000/6x00/DRC	WE017142

Hyper Skimmer Cone and Spares

ICP-MS Model	Description	Part No.
NexION	Hyper Skimmer Cone	W1033995
NexION	Hyper Skimmer O-Ring	09902123
NexION	Hyper Skimmer Screw	WE027484



Part No. **N8145319**



Part No. **N8145320**

ConeGuard Thread Protector

When cleaning cones which have a screw thread, it is important that the thread is not contacted by any corrosive solution. If the thread gets corroded, the cone may not seal correctly or it may bond to the base and be difficult to remove.

ICP-MS Model	Type	Part No.
NexION	Sampler ConeGuard	N8145319
NexION	Skimmer ConeGuard	N8145320
ELAN	Skimmer ConeGuard	N8121086

Sampler and Skimmer Cone O-Rings

ICP-MS Model	Type	Qty.	Part No.
ELAN 9000/6x00/DRC	Sampler	5	N8120511
ELAN 9000/6x00/DRC	Skimmer	5	N8120512



NexION Consumable Kits



NexION 1000/2000 Consumable Kits

Typical one year's supply of consumables.

Description	Qty.	Part No.	2000 B	2000 C	2000 P	2000 S	1000
Configuration			2000 B	2000 C	2000 P	2000 S	1000
NexION 1000/2000 Consumables Kit Part No. Kit Includes:			N8150054	N8150055	N8150056	N8150057	N8150058
Fixed 2.0 mm Injector Quartz Torch (Blue/Purple Mark)	2	N8152472	✓				✓
Fixed 2.5 mm Injector Quartz Torch (Green Mark)	2	N8152473		✓			
Demountable Quartz Torch PVDF	2	N8152379			✓		
2.0 mm Demountable Quartz Injector	2	N8152376			✓		
Fixed 2.0 mm Injector UHP Quartz Torch	2	N8152428				✓	
Glass Cyclonic High Sensitivity Spray Chamber	1	N8152375	✓				
Glass Cyclonic High Sensitivity Spray Chamber with Matrix Gas Port	1	N8152389		✓	✓		✓
SiIQ Cyclonic High Sensitivity Spray Chamber	1	N8152424				✓	
Threaded Spray Chamber Drain Line	2	N8152456	✓	✓	✓	✓	✓
Nickel Skimmer Cone	2	W1026356	✓	✓	✓		✓
Nickel Sampler Cone	2	W1033612	✓	✓	✓		✓
Platinum Skimmer Cone	2	W1026907				✓	
Platinum Sample Cone	2	W1033614				✓	
Hyper Skimmer Cone	1	W1033995	✓	✓	✓	✓	✓
Sampler Cone Gasket	3	W1040148	✓	✓	✓	✓	✓
Hyper Skimmer O-Ring	2	09902123	✓	✓	✓	✓	✓
Gray/Gray Pump Tubing	2	N8152415	✓	✓		✓	✓
Gray/Gray Pump Tubing MP ²	2	N8145173			✓		
Flared PVC 0.51 mm Orange/Yellow Pump Tubing	4	N8152405	✓	✓		✓	✓
Flared PVC 0.51 mm Orange/Yellow Pump Tubing MP ²	4	N8145150			✓		
Drain Tubing (ft.)	6	02506495	✓	✓	✓	✓	✓
PTFE Sample Uptake Tubing	12	WE024375	✓	✓	✓	✓	✓
Sample Introduction Line for PFA-ST Nebulizer	1	N8152455			✓	✓	
Sample Introduction Line for Concentric Nebulizer	1	N8145503	✓	✓			✓
Female Barb CTFE Fitting	4	N8152388	✓	✓	✓	✓	✓
Male Barb CTFE Fitting	4	N8152453	✓	✓	✓	✓	✓
Instrument Filter (Left)	2	N8152167	✓	✓	✓	✓	✓
Instrument Filter (Right)	2	N8152136	✓	✓	✓	✓	✓
Instrument Filter (Rear)	2	N8152465	✓	✓	✓	✓	✓
Torch Injector Nut	2	N8152451	✓	✓	✓	✓	✓



NexION 300/350S Consumable Kits

Typical one year's supply of consumables.

Description	Qty.	Part No.
NexION 300/350S Consumables Kit Kit Includes:		N8140514
Demountable Quartz Torch	2	N8122006
Load Coil	1	WE021816
Quartz Ball Joint Injector 2.0 mm ID	2	WE023948
Cassette Torch Injector Support Adapter for Ball Joint Injectors	1	W1012406
Glass Cyclonic Spray Chamber	1	N8145013
Platinum Skimmer Cone	1	W1026907
Platinum Sampler Cone	1	W1033614
Hyper Skimmer Cone	1	W1033995
Sampler Cone Gasket	3	W1040148
Hyper Skimmer O-Ring	2	09902123
Hyper Skimmer Screw	2	09919737
Santoprene® 1.30 mm Gray/Gray Pump Tubing	4	N0777444
Flared PVC 0.38 mm Green/Orange Pump Tubing	4	N0777042
Drain Tubing (ft.)	6	02506495
PTFE Sample Uptake Tubing (cm)	12	WE024375
Instrument Filter (left)	1	W1036712
Instrument Filter (back right)	1	W1036713
Spray Chamber Drain Fitting	2	N8145015
Nebulizer Fitting	2	N8145016
Male Barb CTFE Fitting	2	N8145017
Female Barb CTFE Fitting	2	N8145018

NexION 300/350Q/X/D Consumable Kits

Typical one year's supply of consumables.

Description	Qty.	Part No.
NexION 300/350Q/X/D Consumables Kit Kit Includes:		N8140513
Demountable Quartz Torch	2	N8122006
Load Coil	1	WE021816
Quartz Ball Joint Injector 2.0 mm ID	2	WE023948
Cassette Torch Injector Support Adapter for Ball Joint Injectors	1	W1012406
Glass Cyclonic Spray Chamber	1	N8145014
Nickel Skimmer Cone	2	W1026356
Nickel Sampler Cone	2	W1033612
Hyper Skimmer Cone	1	W1033995
Sampler Cone Gasket	3	W1040148
Hyper Skimmer O-Ring	2	09902123
Hyper Skimmer Screw	2	09919737
Santoprene® 1.30 mm Gray/Gray Pump Tubing	4	N0777444
Flared PVC 0.38 mm Green/Orange Pump Tubing	4	N0777042
Drain Tubing (ft.)	6	02506495
PTFE Sample Uptake Tubing (cm)	12	WE024375
Instrument Filter (left)	2	W1036712
Instrument Filter (back right)	2	W1036713
Spray Chamber Drain Fitting	2	N8145015
Nebulizer Fitting	2	N8145016
Male Barb CTFE Fitting	2	N8145017
Female Barb CTFE Fitting	2	N8145018

ELAN Consumable Kits



Glass Cyclonic Sample Introduction System for ELAN

Description	Part No.
Glass Cyclonic Sample Introduction System Kit Includes (1 of each):	N8120518
Baffled Glass Cyclonic Spray Chamber O-Ring Free	N0775352
Cyclonic Spray Chamber Mount	WE014034
MicroMist Micro-uptake Glass Concentric Nebulizer 0.2 mL/min	N0775342
Quartz Injector 2.0 mm ID	N8125029
Tygon Tubing (1 foot)	02506516
Insert	09903094
1/4 in. Front Ferrule	09903456
Fitting	09903464
Tube Fitting	09903465
Red/Red Standard PVC Tubing 1.14 mm ID (Pkg. 12)	09908585
Green/Yellow Flared End PVC Tubing 0.44 mm ID (Pkg. 12)	N0773113

Quartz Cyclonic Sample Introduction System for ELAN

Description	Part No.
Quartz Cyclonic Sample Introduction System Kit Includes (1 of each):	N8120519
Baffled Quartz Cyclonic Spray Chamber Baffled Quartz Spray Chamber (PTFE O-Ring Type) with Ball Joint	WE025221
MicroMist Micro-Uptake Glass Concentric Nebulizer 0.2 mL/min	N0775342
Quartz Ball Injector 2.0 mm ID	WE023948
Tygon Tubing (1 foot)	02506516
Insert	09903094
1/4 in. Front Ferrule	09903456
Fitting	09903464
Tube Fitting	09903465
Red/Red Standard PVC Tubing 1.14 mm ID (Pkg. 12)	09908585
Green/Yellow Flared End PVC Tubing 0.44 mm ID (Pkg. 12)	N0773113
Ball Joint Cassette Torch Injector Support Adapter	W1012406
UV Safety Shield	W1020996
Connector 1A	B0199233

ELAN® DRC-e/9000 Spares Kit

Description	Qty.	Part No.
ELAN® DRC-e/9000 Spares Kit Kit Includes:		N8120610
Demountable Quartz Torch	1	N8122006
RF Coil Assembly	1	WE021816
Alumina Injector 2.0 mm ID	1	N8126041
Cross-Flow II Replacement GemTips™	1	N8120515
Series II Ion Lens	1	WE018034
Nickel Sampler Cones	2	WE021140
Nickel Skimmer Cones	2	WE021137
Sampler Cone O-Rings (Pkg. 5)	1	N8120511
Skimmer Cone O-Rings (Pkg. 5)	1	N8120512

ELAN® DRC II Spares Kit

Description	Qty.	Part No.
ELAN® DRC II Spares Kit Kit Includes:		N8120611
Demountable Quartz Torch	1	N8122006
RF Coil Assembly	1	WE021816
Quartz Ball Joint Injector 2.0 mm ID	1	WE023948
Series II Ion Lens	1	WE018034
Platinum Sampler Cone	1	WE027802
Platinum Skimmer Cone	1	WE027803
Sampler Cone O-Rings (Pkg. 5)	1	N8120511
Skimmer Cone O-Rings (Pkg. 5)	1	N8120512

FAST High Productivity Systems

The *FAST* is a high-throughput automated sample introduction system for PerkinElmer ICP-OES and ICP-MS. The *FAST* increases productive instrument time by reducing sample uptake, stabilization and rinse steps, allowing you to run more samples each day.

Features and Benefits

- Sample never touches peristaltic pump tubing
- *FAST* uptake, stabilization and washout
- P-Series valve and loop combination has superb washout
- Carrier stream without segmented air bubbles ensures high-precision sample introduction
- Direct integration of MP² peripump and *FAST* valve with instrument

Description	Type	Part No.
2 DX <i>FAST</i> DXi System NexION 350	2 Rack	N8145074
4 DX <i>FAST</i> DXi System NexION 350	4 Rack	N8145075
2 DX <i>FAST</i> DXi System NexION 2000 B,C,S / 1000	2 Rack	N8150478
4 DX <i>FAST</i> DXi System NexION 2000 B,C,S / 1000	4 Rack	N8150479

8 rack and 14 rack *FAST* DXi Systems also available.
NexION 2000P ICP-MS includes DXi *FAST* valve; just add **N8150390** (2DX Autosampler) or **N8150391** (4DX Autosampler)



4 DX *FAST* DXi System for NexION 300 and 350 ICP-MS

prepFAST Autodilution and Autocalibration Systems

prep*FAST* is an inline dilution system that automatically performs precise and accurate dilutions for samples and standards, improving laboratory workflow, productivity and data quality.

Features and Benefits

- Autodilution
- Autocalibration
- Automatic IS addition
- Auto QC dilution
- Automatic standard addition

Description	Type	Part No.
2 DX prep <i>FAST</i> System NexION 350	2 Rack	N8145280
4 DX prep <i>FAST</i> System NexION 350	4 Rack	N8145281
2 DX prep <i>FAST</i> System NexION 2000 B,C,S / 1000	2 Rack	N8150468
4 DX prep <i>FAST</i> System NexION 2000 B,C,S / 1000	4 Rack	N8150469
2 DX prep <i>FAST</i> System NexION 2000 P	2 Rack	N8150472
4 DX prep <i>FAST</i> System NexION 2000 P	4 Rack	N8150473
8 DX prep <i>FAST</i> System NexION 2000 B,C, S/ 1000	8 Rack	N8150470
14 DX prep <i>FAST</i> System NexION 2000 B,C, S/ 1000	14 Rack	N8150471

See page 89 for additional ESI DX Autosamplers



2 DX prep*FAST* System for NexION 2000 ICP-MS

Atomic Spectroscopy General Supplies

PerkinElmer offers a wide selection of superior quality products designed to work with your PerkinElmer instruments. Our precision designed products deliver the peace of mind that comes from knowing that you'll get the results you need.

Quick Reference Index Page

➤ Autosamplers	89
➤ Chillers	90
➤ Noise Enclosures	91
➤ Power Conditioners and UPS Systems	92
➤ Regulators and Filters	94
➤ Peristaltic Pump Tubing	96
➤ Internal Standard Kits	98
➤ Autosampler Racks and Probes	100
➤ Autosampler Tubes	104
➤ Benches and Accessory Carts	106

Chillers

PerkinElmer offers a PolyScience® WhisperCool™ Recirculating Chiller for your ICP-OES and ICP-MS instruments. The WhisperCool Chiller is designed to deliver quiet and reliable performance over a broad range of operating temperatures and conditions.



➤ [VIEW PAGE](#)

Power Conditioners and UPS Systems

Powervar power quality solutions combine specific technologies that ensure sensitive analytical equipment will operate optimally on a day to day basis and for the long run. Power disturbances can result in quality issues undermining instrument performance and user confidence.



➤ [VIEW PAGE](#)

Peristaltic Pump Tubing

PerkinElmer offers a wide range of high-quality peristaltic pump tubing for all of your AA, ICP-OES and ICP-MS applications.



Remember to replace your tubing frequently and always keep spares on hand.

➤ [VIEW PAGE](#)

Autosampler Supplies

PerkinElmer offers a wide variety of Autosampler Racks, Probes and Tubes for your PerkinElmer, Cetac and ESI Autosamplers.



➤ [VIEW PAGE](#)

Benches and Accessory Carts

PerkinElmer offers custom Benches and Accessory carts for your instrumentation and accessories.



➤ [VIEW PAGE](#)

➤ [TABLE OF CONTENTS](#)

➤ [ORDER ONLINE](#)

➤ [CLICK THE ARROWS TO VIEW EACH PAGE](#)

Autosamplers

PerkinElmer offers a wide range of Autosamplers to perform your routine analysis and your high productivity lab.

PerkinElmer S10 Autosampler

Ruggedly designed, the S10 features corrosion-resistant components to ensure long-term reliability, reproducibility and precise performance. The PerkinElmer® S10 autosampler is a computer-controlled, multi-purpose sampling system for AA, ICP-OES and ICP-MS. The autosampler automates standard and sample introduction for instrument calibration and sample analysis, extending the spectrometer's capabilities to those of a fully automated analytical workstation.



ESI DX Autosamplers

DX Autosampler systems are customizable solutions specially designed for your application needs. We offer a comprehensive selection of sample introduction products for specific trace-metal and non-metal applications, including semiconductor pure chemicals, environmental, clinical, organic solvents, isotope ratio and many other types of trace metal determinations. The DX systems are durable, acid resistant autosamplers which feature dual rinse stations (each with dedicated rinse pump) to eliminate carryover. All DX models may be upgraded to analyze samples up to 3X faster (*FAST*) and with auto dilution (prep3 or prep*FAST*).

DXe models also have dual rinse stations (supplied by one rinse pump) and can be upgraded with 2nd rinse pump with vacuum pump for *FAST* automation.

Cetac ASX Autosamplers and Prep Station

More features and improved performance define the latest generation of autosamplers from Teledyne CETAC Technologies. CETAC Automation provides immediate solutions to the various challenges typical in laboratory environments with a variety of products and accessories including autosamplers, autodilutors and liquid handling stations.

Description	Type	Part No.
ASX-280 Autosampler	2 Rack	N0782036
ASX-280 Autosampler Oils	2 Rack	N0780825
ASX-560 Autosampler	4 Rack	N0782035
ASX-860 Extended 8 Rack Autosampler	8 Rack	N0780826
ASX-1400 with CETAC 96-Position Racks	4 Rack	N0771650
ASX-1400 with Gilson 60-Position Racks	4 Rack	N0777174
ASX-1400 with CETAC 80-Position Racks	4 Rack	N0777175
ASX-1400 with CETAC 90-Position Racks	4 Rack	N0777176
ASX-1400 with PerkinElmer OE4 Racks	4 Rack	N0777196
ASX-1600 with CETAC 96-Position Racks	6 Rack	N0777687
APS-1650 Automated Preparation Station	4 Rack	N0777177

Description	Type	Part No.
2 DXe Dual Rinse Autosampler	2 Rack	N0786010
2 DX <i>FAST</i> Ready Dual Rinse Autosampler	2 Rack	N8150390
4 DXe Dual Rinse Autosampler	4 Rack	N0786011
4 DX <i>FAST</i> Ready Dual Rinse Autosampler	4 Rack	N8150391
8 DX <i>FAST</i> Ready Dual Rinse Autosampler	8 Rack	N0777342
8 DX Benchtop <i>FAST</i> Ready Dual Rinse Autosampler	8 Rack	N8145400
14 DX <i>FAST</i> Ready Dual Rinse Autosampler	14 Rack	N0777319
14 DX Benchtop <i>FAST</i> Ready Dual Rinse Autosampler	14 Rack	N8145329



Cooling Systems

PolyScience® WhisperCool™ Refrigerated Chiller

The PolyScience® WhisperCool® Refrigerated Chiller is designed to deliver quiet and reliable performance over a broad range of operating temperatures and conditions. Extremely dependable and energy efficient, it features a -10 to 40 °C operating temperature range, built-in process and equipment protection and highly intuitive user interface. This chiller is designed for use on both ICP-OES and ICP-MS instruments.

Features and Benefits

- 50% quieter operation than comparable models (62 dB*)
- 2900 watts (9889 BTU/hour) cooling capacity
- Built-in temperature, pressure and flow rate alarms

* WhisperCool® environmental control reduces operational noise (62 dB)

Part No.	N0772046	N0772045
Electrical Requirements	208-230 V, 60 Hz, 12.2 A	240 V, 50 Hz, 12.2 A
Operating Temperature Range	-10 to 40 °C	-10 to 40 °C
Temperature Stability	±0.1 °C (±1.8 °F)	±0.1 °C (±1.8 °F)
Cooling Capacity	at 20 °C 2900 Watts (9889 BTU/hr) at 10 °C 1925 Watts (6574 BTU/hr) at 0 °C 1000 Watts (3410 BTU/hr)	2650 Watts (9889 BTU/hr) 1900 Watts (6574 BTU/hr) 1200 Watts (3410 BTU/hr)
Compressor	1.0 HP	1.0 HP
Reservoir Capacity	4.2 L	4.2 L
Pump Type	Turbine	Turbine
Maximum Pump Pressure	90 PSI	83 PSI
Maximum Pump Flow	13.2 L/min	13.2 L/min
Dimensions	22 5/8 x 14 1/2 x 27 5/8 in. / 57.6 x 36.8 x 70.2 cm	
Shipping Weight	189 lbs. / 85.7 kg	
Replacement Air Filter	N0777095 (Air Filter with Frame, 13 x 14 in.)	
ICP Chiller Coolant Mix	N0776200 (Five Half-gallon bottles)	
ICP-MS Chiller Coolant Mix	WE016558 (1 L bottles) for ELAN/NexION	
Stainless Steel Strainer for Reservoir	N0691907	

ICP Chiller Coolant Mix
Part No: **N0776200**

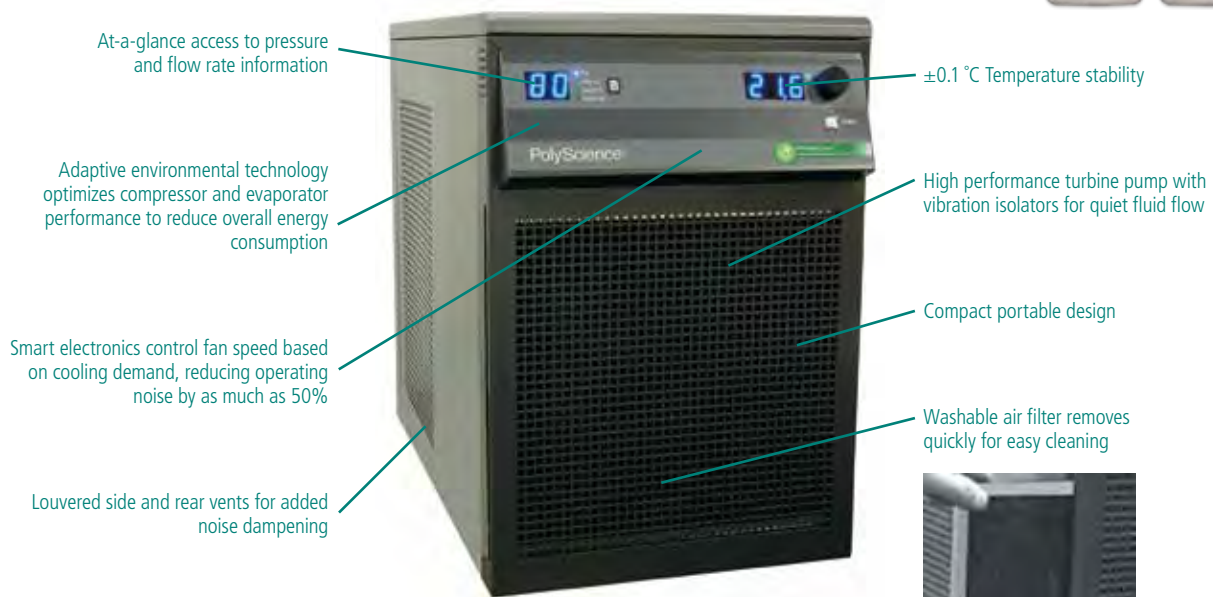

Noise Enclosures for Vacuum Pumps and Chillers



Vacuum Pump Noise Enclosure



Vacuum Pump Noise Reduction Cover

Laboratories can be loud and noise in labs is distracting, stressful and potentially harmful to your hearing. While noise in labs may not be frequently talked about, it is something you should be concerned with.

Our noise reduction enclosures are designed specifically for your instrument. They provide noise reduction performance from -12 db(A) up to -20 db(A), equivalent to a 75% reduction in noise perception! Thick 50 mm Polyurethane acoustic open cell foam covers the interior part of the enclosure, delivering good noise absorption. The wave shape of the foam multiplies the absorption capacity, providing you with a quieter, safer lab.

Vacuum Pump Noise Enclosure For NexION® Leybold SV40 Vacuum Pump

External Dimensions	Centimeters (cm)	Inches (in.)
Depth	67.4	26.5
Width	45.6	17.95
Height	55	21.65
Height with Oil Tray	64.6	25.39
Weight	Kilograms (kg)	Pounds (lbs)
Enclosure	14	30.8
Oil Tray	8	16.75

Description	Part No.
Noise Enclosure (Dolly not Included)	N8121068
Noise Enclosure with Built-In Overheating Temperature Alarm (Dolly not Included)	N8145407
Noise Enclosure Dolly (Option)	N8121069

Vacuum Pump Noise Reduction Cover

Description	Part No.
Noise Reduction Cover (Dolly not Included)	MZ321146
Noise Reduction Cover Dolly (Option)	MZ321147

Chiller noise in the lab can be distracting, tiring, irritating and stressful. But many people are unaware of the presence of environmental sound at damaging levels, or at the level on which sound becomes harmful.

Chiller Noise Enclosure Features and Benefits

- Performance: average sound level decrease is – 15 dB(A) (equivalent to a 75% reduction in noise perception)
- Environment friendly noise adsorbing material, oil and water resistant
- Heat exchange controlled by six internal silent fans
- Worldwide electrical compatibility-enclosures are delivered with European, US, Japan and UK plugs
- Easy access to front monitor and switch (the transparent window can be opened)
- Easy water level check (window on the back panel)
- Includes overheating temperature alarm
- The noise reduction is in conformity with the European directive related to low voltage equipment (2006/95/EC) and electromagnetic compatibility (2004/108/EC)

Chiller Noise Enclosure For Polyscience 6000 Series

External Dimensions	Centimeters (cm)	Inches (in.)
Depth	88	34.7
Width	57	23.7
Height	71	30.7
Description	Part No.	
Chiller Enclosure	N0777920	



Chiller Noise Enclosure

Power Conditioners and UPS Systems

PerkinElmer/Powervar power quality solutions combine specific technologies that ensure sensitive analytical equipment will operate optimally on a day to day basis and for the long run. Power disturbances can result in quality issues undermining instrument performance and user confidence. Damaged or compromised components, disrupted processes, lack of reliability – they all add up to frustration, broken schedules and costly downtime. The problem is caused by a host of power disturbances – some visible and many invisible – that threaten your equipment’s operation every year. Power ‘disturbances’ are simply those large and small variations in the quality of the electric power you use day in and day out. Some come from your local utility company, but most are created within your own facility as a result of the distribution and use of electrical power. These variations include high-energy voltage transients, sags and swells, electrical noise and common mode voltage, as well as the power outages everyone witnesses when the lights go out.

Power Conditioners

Features and Benefits

- Conditioners provide clean power at 120, 208, or 240 VAC for loads up to 62 amps
- Dual-output models can protect both high-voltage system loads and low-voltage peripherals at less expense and effort than installing two conditioners
- Protects against: high-voltage surges, common-mode voltage, electrical noise, voltage swells and sags, power outages, unstable AC frequency, ground loops



Instrument Model	Description	Input Voltage	Frequency (Hz)	Part No.
Atomic Absorption				
AAnalyst 100/200/300/400	520 VA	120 V	60	N9307504
PinAAcle 500/900 F	840 VA	120 V	60	N9307517
AAnalyst 100/200/300/400, PinAAcle 500/900 F	750 VA	220/230 V	50	N9307521
AAnalyst 600/800	5.8 kVA	208/240 V	60	N9307511
AAnalyst 600/800	6.0 kVA	220/230 V	50	N9307523
AAnalyst 700	3.8 kVA	208/240 V	60	N9307509
AAnalyst 700	3.6 kVA	220/230 V	50	N9307522
PinAAcle 900 H/T/Z	5.8 kVA	208/240 V	60	N9307760
PinAAcle 900 H/T/Z	6.0 kVA	220/230 V	50	N9307523
PinAAcle 500/900 F	1440 VA	120 V	60	N9307503
PinAAcle 500/900 F	1500 VA	220/230 V	50	N9306752
Inductively Coupled Plasma-OES				
Optima™ 2x00/4x00/5x00/7x00/8x00, Avio 200/500	3.8 kVA	208/240 V	60	N9307512
Optima 2x00/4x00/5x00/7x00/8x00, Avio 200/500	3.6 kVA	220/230 V	50	N9307522
Inductively Coupled Plasma-MS				
ELAN® 6x00/9000 Controller Side	3.8 kVA	208/240 V	60	N9307519
ELAN 6x00/9000 Controller Side	3.6 kVA	220/230 V	50	N9307522
ELAN 6x00/9000 RF Generator Side	5.8 kVA	208/240 V	60	N9307511
ELAN 6x00/9000, NexION® RF Generator Side	6.0 kVA	220/230 V	50	N9307523
NexION 300/350/1000/2000	5.0 kVA	208/240 V	60	N0777690
Titan MPS™				
Titan MPS	2.0 kVA	208/240 V	60	N9306758
Titan MPS	2.0 kVA	220/230 V	50	N9306755

Power Conditioners include a POWERVAR five-year warranty on parts and labor.

UPS Systems

On-Line Conditioned Uninterruptible Power Supply Systems

With the Security Plus Series, you get much more protection and a higher comfort level than you get with most other UPS systems. The Security Plus Series also provides complete power conditioning and, because the Security Plus Series features on-line inverter design, added peace of mind. And regardless of input fluctuations, the Security Plus Series insures that the output remains continuous and regulated.



Instrument Model	Description	Input Voltage	Frequency (Hz)	Part No.
Atomic Absorption				
PinAAcle 500	1440 VA	120 V	60	N9306750
PinAAcle 500	1440 VA	220/230 V	50	N0777798
PinAAcle 900F, AAnalyst 100/200/300/400	800 VA	120 V	60	N0777681
PinAAcle 900F, AAnalyst 100/200/300/400	800 VA	220/230 V	50	N0777689
AAnalyst 700, HGA 900	5.2 kVA	208/240 V @ 50Hz 220/230 V @ 60Hz	50/60	N9308150
PinAAcle 900 T/H/Z	10 kVA	208/240 V @ 50Hz 220/230 V @ 60Hz	50/60	N9306757
AAnalyst 600/800	10 kVA	208/240 V @ 50Hz 220/230 V @ 60Hz	50/60	N0777613
Inductively Coupled Plasma-OES				
Optima 2x00/4x00/5x00/7x00/8x00, Avio 200/500	5.2 kVA	208/240 V @ 50Hz 220/230 V @ 60Hz	50/60	N0777511
Inductively Coupled Plasma-MS				
NexION 300/350/1000/2000	8.0 kVA	208/240 V @ 50Hz 220/230 V @ 60Hz	50/60	N0777682
ELAN	12 kVA	208/240 V @ 50Hz 220/230 V @ 60Hz	50/60	N0777719

UPS Systems include a POWERVAR three-year warranty (two-year on batteries) on parts and labor.

Extended Run Battery Cabinets

Description	Shipping Weight	Part No.
Extended Run Battery Cabinet 30 min additional run time battery for Optima/Avio. 208/240 Volt, 8 Amp input for internal charger Compatible with: N0777511 or N9308150	413 lbs. (187 kg)	N0777727
Extended Run Battery Cabinet 60 min additional run time battery for Optima/Avio. 208/240 Volt, 8 Amp input for internal charger Compatible with: N0777511 or N9308150	497 lbs. (225 kg)	N0777728
Extended Battery Cabinet 45 min additional run time battery for NexION. 208/240 Volt input for internal charger Compatible with: N0777682	746 lbs. (338 kg)	N0777729

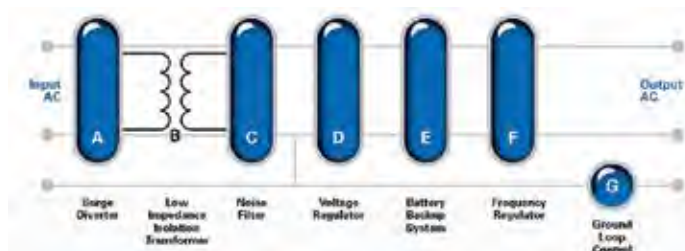

The ABC's of power conditioning

Laboratory Products

Acetylene Regulator

For AA labs, this regulator includes an adapter so that the pressure regulator can be connected to cylinders requiring either CGA 300 or CGA 510 fittings and a connector for attaching the fuel hose assembly supplied with the instrument. Includes hose assembly.



Description	Part No.
Max Inlet Pressure: 400 psig	03030106

Air Regulator

For AA labs. Regulator to cylinder CGA no. 590. Includes hose assembly.



Description	Part No.
Max Inlet Pressure: 3,000 psig	03030264

Nitrous Oxide Regulator

For use in AA labs with gas cylinders with a CGA 326 connection. Provides pressure control from 350-520 kPa (50-75 psig) and contains an integral thermostatted heater to prevent freezing of the regulator diaphragm.



Description	Part No.
115 V	03030204
220 V	03030349

Argon/Nitrogen Regulator

For AA and ICP, this regulator can be used with argon or nitrogen and has a CGA 580 fitting. A color-coded hose with 1/4 in. SWAGELOK® fittings is also included.



Description	Part No.
Max Inlet Pressure: 3,000 psig	03030284

Matheson Flashback Arrestor

Because acetylene is an extremely unstable gas, users can experience flashbacks at the instrument burner head. The flash arrestor prevents these potentially dangerous flashbacks from reaching the regulator or cylinder.



Description	Part No.
Acetylene Max Operating Pressure: 15 psig	N9300068

Hose Assemblies

Hose assemblies for connecting fuel, air and nitrous oxide from supply to instrument.



Description	Part No.
Acetylene, Red Neoprene, 3.7 m (12 ft.)	00570559
Air/Argon, Black, 3.7 m (12 ft.)	00570567
Nitrous Oxide, Blue, 3.7 m (12 ft.)	00470258

Blower and Vent Assembly for AA and ICP

A venting system is required to remove fumes and vapors from the torch of ICP emission spectrometers. A vent is recommended for use over the power supply unit of most ICP spectrometers for removal of dissipated heat.

Use exhaust venting to:

- Protect lab personnel from toxic vapors
- Protect your instrument from corrosive vapors
- Improve stability of the ICP torch



Blower and vent assemblies do not include ducting.

Description	Part No.
110 V PinAAcle/Optima Includes Exhaust Hood, Blower and Adapter	03030447
230 V PinAAcle/Optima Includes Exhaust Hood, Blower and Adapter	03030448
110 V Avio 200/500 Includes Blower and Adapter	N0790188
230 V Avio 200/500 Includes Blower and Adapter	N0790189
Flexible Gas Hosing 100 mm ID x 3 m hosing for RF Generator Exhaust Vent	N0691578

PerkinElmer service engineers are not permitted to install this unit

Parker Balston® 73-099 AA Gas Purifier

For AA labs, this wall-mounted system designed to purify the compressed air and acetylene gases used in atomic absorption. It consists of two independent filtration systems, one for compressed air and one for acetylene. The unit also has a flashback arrestor on the acetylene line and a pressure regulator on the compressed air line.



The 2-stage air filtration assembly consists of a Balston Grade DX coalescing filter and a Balston Grade BX coalescing filter. Together these filters remove trace amounts of oil, water and particulate contamination (99.99% at 0.01 micron) from the compressed air supply.

Warning, this filter will not protect an instrument from acetylene tanks that have been overfilled with acetone, or from standard sized tanks that are below 85 psi.

Description	Part No.
Parker Balston 73-099 AA Gas Purifier	N9301398

Parker Balston® Replacement Filters

Description	Cartridges Part No.	Seal Sets Part No.
1st Air Filter	N9301710	N9301712
2nd Air Filter	N9301711	N9301712
Acetylene Filter	N9301714	N9301715

Balston® 95A Acetylene Filter

For your AA lab, this filter includes a Balston Grade BQ filter cartridge to remove trace amounts of liquid and solid contaminants from the acetylene supply to 99.99% at 0.01 micron. Max working pressure: 15 psig.



Warning, this filter will not protect an instrument from acetylene tanks that have been overfilled with acetone, or from standard sized tanks that are below 85 psi.

Description	Part No.
Acetylene Filter	N9301399
Replacement Acetylene Filter Cartridge	N9301714

Balston® Air Filter Assembly Type A-82

For AA and ICP labs, this filter is specifically designed to remove water, oil and dirt particles down to 0.6 microns in diameter from compressed air lines. It is recommended for use with oil-type compressors and for removing moisture and dirt particles from air supplied by oil-less compressors. Also recommended to filter argon for the PinAAcle furnace.



Description	Part No.
Air Filter Assembly	N0580531
Replacement Filter Cartridge Element	N0582251

Air Dryer Filter Assembly with R250 Regulator

To filter compressed air for AA and ICP instrumentation. Replaces **00470652** and **N0770198**.



Description	Part No.
Air Dryer Filter Assembly with R250 Regulator	N0775325
Replacement Filter Element	N9306067
Float Assembly	N0777710
Bowl O-Ring	N0777328

Wilkerson® Air Dryer Filter Accessories*

Description	Pre-Filter Part No.	Final Filter Part No.
Filter Elements	09923464	09907120
Filter Bowls	N9302199	N9302199
Bowl O-Ring Kit, Final Filter	N9302197	N9301715

* For Wilkerson Filter PerkinElmer (00470652)

ICP Filter Replacement Parts

ICP Model	Filter Element	Final Filter Part No.
2x00/3x00/4x00/5x00/7x00/8x00	Air Filter in Front of Spectrometer Fan	09995098
2x00/3x00/4x00	Water Filter	09904845
2x00/3x00/4x00	Cartridge for Water Filter	09904846
2x00/4x00/5x00/7x00/8x00	Air Filter for the RF Generator Inlet	N0775220
3x00	Washable Air Filter for the RF Generator Inlet	02509115
3x00	Disposable Air Filter for the RF Generator Inlet	09923517

Instrument Filters

Description	Part No.
For AAnalyst 100/300/PinAAcle 900	09995097
For AAnalyst 200/400/600/700/800	B0501696
For AAnalyst 600/700/800 (80x80)	B0502706
For Optima 2x00/3x00/4x00/5x00/7x00/8x00 Avio 200/500	09995098
For NexION 300/350 (Left)	W1036712
For NexION 300/350 (Back Right)	W1036713
NexION 1000/2000 Instrument Filter (Left)	N8152167
NexION 1000/2000 Instrument Filter (Right)	N8152136
NexION 1000/2000 Instrument Filter (Back)	N8152465

Polyscience Replacement Air Filters

Description	Part No.
Polyscience Air Filter	N0777359
Polyscience Air Filter with Frame	N0777095
Heat Exchanger Air Filter	N0777360

Peristaltic Pump Tubing

PerkinElmer offers a wide range of high-quality peristaltic pump tubing for all of your AA, ICP-OES and ICP-MS applications. Remember to replace your tubing frequently and always keep spares on hand.

Two-Stop Peristaltic Pump Tubing for Optima, Avio and NexION 300/350

ID (mm)	Stop Colors	Standard PVC (Pkg. 12)	Flared PVC (Pkg. 12)	Solvent Flex (Pkg. 12)	Viton® (Pkg. 12)	Santoprene® (Pkg. 12)	Silicone (Pkg. 6)
0.19	orange red	N0695476	N0773111				
0.25	orange blue	N0773117	N0773112				
0.38	orange green	N0777110	N0777042	N0777874			
0.44	green yellow		N0773113				
0.51	orange yellow		N0777476		N0777446		
0.64	orange white		N0777711				
0.76	black black	09908587	N0777043	00473550	N0773118		00473552
1.02	white white				N0777442		N0777441
1.14	red red	09908585		09923037	N0773115	N0773119	N0691595
1.3	gray gray				N0777445	N0777444	N0777443
1.42	yellow yellow	N0777521					
1.52	yellow blue	09923536					
1.65	blue blue				N0777447		
1.85	green green	N0777518				N0773116	
2.06	purple purple	N0777561					
2.79	purple white			02508080			09923448
3.18	black white	N8122012					

Three-Stop Peristaltic Pump Tubing for FIAS, FIMS and S10

ID (mm)	Stop Colors	Standard PVC Clear (Pkg. 12)	Pharmed Tan (Pkg. 12)	Solvent Resistant Yellow (Pkg. 12)
1.65	black black black	B0506058	N0773111	
1.75	white white white			B0507692
1.85	red red red	B0193160	*B3140730 (Pkg. 6)	
2.06	yellow blue yellow	B0193161		
2.2	purple purple purple	B0199034		
2.54	purple white purple		*B3140721 (Pkg. 6)	
2.79	black white black	B0508310		
0.51	orange yellow orange	B0506737		

* Used for S10 and AS9X autosamplers



Peristaltic Pump Tubing Starter Kit for NexION 1000/2000 – for Standard Pump











Peripump Tubing Kit (Starter Pack of Tubing Includes 4 of each commonly used sizes)			Part No. N8150060
ID (mm)	Stop Colors	Qty.	Type
0.19	orange red	4	PVC Pure
0.44	green yellow	4	PVC Pure
0.51	yellow orange	4	PVC Pure
1.3	gray gray	4	Santoprene

Standard Pump Tubing – for NexION 1000/2000*

ID (mm)	Stop Colors	PVC Pure (Pkg. 12) Part No.	Solvent Flex (Pkg. 12) Part No.	Santoprene (Pkg. 12) Part No.
0.19	orange red	N8152401	N8152408	
0.25	orange blue	N8152402		
0.38	orange green	N8152403	N8152409	
0.44	green yellow	N8152404	N8152410	
0.51	orange yellow	N8152405		
0.64	orange white	N8152406	N8152411	
0.76	black black	N8152407	N8152412	
1.14	red red		N8152413	N8152414
1.3	gray gray			N8152415





















































* Excluding NexION 2000 P Configuration

Peristaltic Pump Tubing Starter Kit for NexION 2000 P Configuration – for MP² Pump

Peripump Tubing Kit (Starter Pack of Tubing, Includes 4 of each commonly used sizes)			Part No. N8152380
ID (mm)	Stop Colors	Qty.	Type
1.30	 gray  gray	4	Santoprene
0.76	 black  black	4	PVC Flared
0.51	 orange  yellow	4	PVC Flared
0.38	 orange  green	4	PVC Flared
0.19	 orange  red	4	PVC Flared



MP² Two-Stop Peristaltic Pump Tubing

ID (mm)	Stop Colors	Slope (L/min per RPM)	PVC 2-Stop	Non-Flared		Flared	
				Santoprene 2-Stop	Solva 2-Stop	PVC 2-Stop	Solva 2-Stop
0.13	 orange  black	0.6	N8145145			N8145194	N8145208
0.19	 orange  red	1.3	N8145146			N8145195	N8145209
0.27	 orange  blue	2.7	N8145147			N8145196	N8145210
0.38	 orange  green	4.7	N8145148	N8145171		N8145197	N8145211
0.44	 green  yellow	7.6	N8145149			N8145198	N8145212
0.51	 orange  yellow	9.5	N8145150			N8145199	N8145213
0.57	 white  yellow	11	N8145151			N8145200	N8145214
0.64	 orange  white	14	N8145152			N8145201	N8145215
0.76	 black  black	19	N8145153	N8145172	N8145176	N8145202	N8145216
0.89	 orange  orange	24	N8145154		N8145177	N8145203	N8145217
0.95	 white  black	28	N8145155		N8145178	N8145204	N8145218
1.02	 white  white	31	N8145156		N8145179	N8145205	N8145219
1.09	 white  red	33	N8145157		N8145180	N8145206	N8145220
1.14	 red  red	35	N8145158		N8145181	N8145207	
1.22	 red  gray	46	N8145159		N8145182		
1.3	 gray  gray	47	N8145160	N8145173	N8145183		
1.42	 yellow  yellow	50	N8145161		N8145184		
1.52	 yellow  blue	51	N8145162	N8145174	N8145185		
1.65	 blue  blue	55	N8145163		N8145186		
1.75	 blue  green	58	N8145164		N8145187		
1.85	 green  green	61	N8145165		N8145188		
2.06	 purple  purple	64	N8145166		N8145189		
2.2	 purple  black	65	N8145167		N8145190		
2.54	 purple  orange	67	N8145168		N8145191		
2.79	 purple  white	69	N8145169		N8145192		
3.17	 black  white	70	N8145170	N8145175	N8145193		

Internal Standard Kits

In-line Standard Additions kits, one which includes a glass mixing chamber/combiner for solutions which do not contain HF and another which includes an inert mixing chamber/combiner. Both kits are completely modular so that damaged or worn components can easily be replaced. The heart of the kit is the mixing chamber/combiner. It is designed for zero dead volume on the input ends which accommodate the sample and addition lines. The output end is designed with a small mixing chamber so that the sample and added reagent are intimately mixed prior to introduction to the nebulizer. All connections to the mixing chamber/combiner use EzyFit connectors. A sampling probe for the reagent addition bottle is included so that it remains well anchored in the bottle. In-line addition of internal standards and ionization buffers provides an efficient means of accurately and precisely dosing all of your samples without extra effort or the risk of error or contamination. Internal standardization is often used to compensate for physical and mass-space interferences in ICP spectrometry. In many cases, it also enhances short-term and long-term reproducibility.

HF-Resistant Internal Standard Kit

Description	Part No.
HF-Resistant Internal Standard Kit Includes:	N0774067
HF Mixing T-Piece	N077466
Internal Standard Sample Probe 0.25 mm ID	N077465
EzyFit Sample Tube 0.5 mm ID	N077463
UniFit-EzyFit Sample Tube	N077061
EzyFit Internal Standard Tube 0.25 mm ID	N077464
Vitex® Gripper Paper – Qty. 6	N077848
Orange/Blue Flared End PVC Tubing 0.25 mm ID – Qty. 12	N0773112

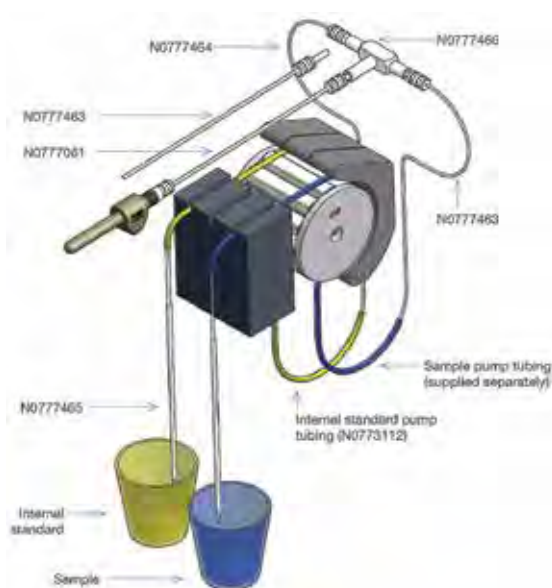

Non HF-Resistant Internal Standard Kit

Description	Part No.
Non HF-Resistant Internal Standard Kit Kit Includes:	N0774068
EzyFit Glass Mixing T-piece	N077461
Internal Standard Sample Probe 0.25 mm ID	N077465
EzyFit Sample Tube – Twin	N077462
EzyFit Sample Tube 0.5 mm ID	N077463
EzyFit Internal Standard Tube 0.25 mm ID	N077464
Vitex® Gripper Paper – Qty. 6	N077848
Orange/Blue Flared End PVC Tubing 0.25 mm ID – Qty. 12	N0773112
UniFit-EzyFit Sample Tube	N077061

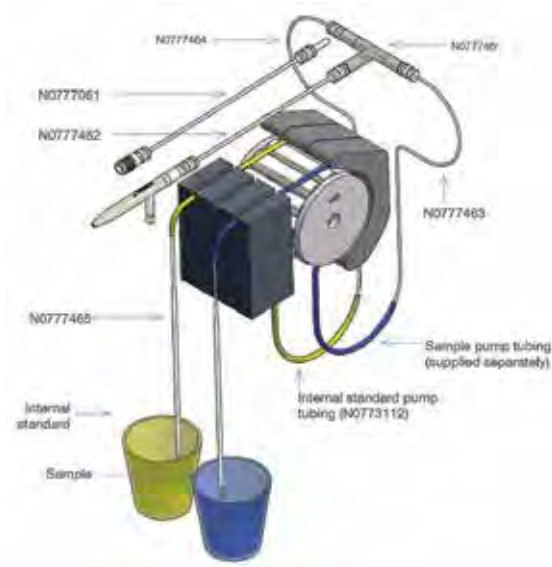

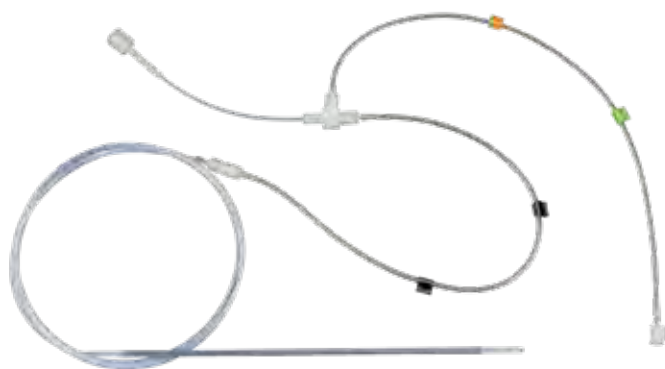

Part No. **N8152571**

Internal Standard Addition Kits

NexION 1000/ 2000 internal standards kits utilize a low-internal volume mixing tee for in-line addition of internal standard with sample. Utilizing the MP² micro peristaltic pump to achieve the highest level of accuracy and precision, the internal standards kit is available for both PFA-ST and MEINHARD[®] Plus nebulizers.

Includes:

- Fluoropolymer mixing tee (0.5 mm ID)
- Internal standard probes
- Fluoropolymer peripump fittings
- MP² peripump tubing

Description	Part No.
Internal Standards Kit for MEINHARD [®] Plus Nebulizer. Includes PFA Tee, Fittings, IS Probe, SPP Starter Flared Pump Tubing Pack (Orange/Green, Black/Black, Pharmed Gray/Gray)	N8152421
Internal Standards Kit for PFA-ST Nebulizer. Includes PFA Tee, Fittings, IS Probe, SPP Starter Flared Pump Tubing Pack (Orange/Green, Black/Black, Pharmed Gray/Gray)	N8152571
Organic Solvent IS Kit for Nebulizer. Includes PFA Tee, fittings, IS Probe, SPP Starter Viton Pump Tubing Pack (PVC Orange/Green/ Viton Black/Black, Viton Gray/Gray)	N8152422



Part No. **N8152423**



Part No. **N8152386**

Internal Standard Addition Tees

NexION 1000/2000 internal standard mixing tee is perfect for online addition of internal standard or online dilution. Achieves excellent mixing with minimal dead volume.

Description	Part No.
Internal Standard Addition Tee 0.5 mm ID (Orange) for PFA-ST Nebulizer	N8152423
Internal Standard Addition Tee 0.5 mm ID (Orange) for MEINHARD [®] Plus Nebulizer	N8152386

Fittings

Description	Qty.	Part No.
Black, High-Flow Nut (1/4-28) for FASTValve and 1/16 in. (1.6 mm) Ferrule	10	N0777283
White, High-Flow Nut (1/4-28) for FASTValve and 1/8 in. (3.2 mm) Ferrule	10	N0777297
1/16 in. (1.6 mm) Ferrule for High-Flow Fitting (1/4-28)	10	N8145237
1/8 in. (3.2 mm) Ferrule for High-Flow Fitting (1/4-28)	10	N8145238
Black, Low-Flow Nut (M5/10-32) for FASTValve	10	N0777284
Female Perilink Fitting, Barbed	1	N8152388
Female Perilink Fitting	5	N0786030
Male Perilink Fitting, Barbed	1	N8152453
Male Perilink Fitting	5	N0786036
PFA-ST Nebulizer to Micro Fitting Adapter, PFA	1	N8145520
MEINHARD [®] Plus Nebulizer to Micro Fitting Adapter	1	N8152387
Barbed for Low Pressure Applications (Female)	1	N8145018
Barbed for High Pressure Applications (Male)	1	N8145017
Non-Barbed for Low Pressure Applications (Female)	1	N0777829
Non-Barbed for High Pressure Applications (Male)	1	N0777830

PerkinElmer Autosampler Supplies



PerkinElmer AS-9x/S10 Sampling Probe Assemblies

Stainless Steel

Description	Part No.
Flame Sampling Probe Assembly, 0.6 mm ID Includes Stainless Steel Sampling Probe and Screw Fitting (B3000152) and Flame Capillary (B3000157 – Replaces B0196963) Tubing Assembly	B3000159
FIAS™ Sampling Probe Assembly, 0.6 mm ID Includes Stainless Steel Sampling Probe and Screw Fitting (B3000152) and FIAS Capillary Tubing Assembly (B3000158 – Replaces B0196966)	B3000160
FIAS Standard Sampling Probe Assembly, 1.0 mm ID Includes Stainless Steel Sampling Probe and Screw Fitting (B3000152) and FIAS Capillary Tubing Assembly (B0191060 – Replaces B0501044)	B3000161

Corrosion-Resistant

Corrosion-resistant probes are suitable for inorganic acids and most organic solvents, except NMP.

Description	Part No.
Flame Sampling Probe Assembly, 0.6 mm ID* Includes Sampling Probe with FEP Tube and Screw Fitting (B3000055) and Capillary Tubing Assembly (B3000157). Standard with AS93plus/S10	B3001770
FIAS Sampling Probe Assembly, 0.6 mm ID* Includes Sampling Probe with FEP Tube and Screw Fitting (B3000055) and FIAS Capillary Tubing Assembly (B3000158)	B3001771
FIAS Standard Sampling Probe Assembly, 1.0 mm ID* Includes Sampling Probe with FEP Tube and Screw Fitting (B3001769) and Capillary Tubing Assembly (B0191060)	B3001772

*This probe cannot be used with AS-90s, with the older sampling probe holder

PTFE

PTFE probes provide laminar flow and are the most resistant to chemical degradation.

Description	Part No.
PTFE Sampling Probe Assembly with Carbon Fiber Support and Female Fitting, 0.25 mm ID for ICP-MS. Requires but does not include N8145017	N8145139
PTFE Sampling Probe Assembly with Carbon Fiber Support and Female Fitting, 0.5 mm ID for ICP/ICP-MS. Requires but does not include N8145017	N8145140
PTFE Internal Standard Probe, 0.5mm with Carbon Fiber Support with female nut. Connects to standard addition tee or internal standard line	N8145344
PTFE Sampling Probe Assembly with Carbon Fiber Support and Male Screw Fitting, 0.55 mm ID for AA/ICP/ICPMS. For ICP/ICPMS requires but does not include N8145018* . For AA with a stainless steel nebulizer, the male connect should be removed so that tubing can be directly connected to the nebulizer, no additional tubing is required	N2024132
PTFE Flame Sampling Probe Assembly and Male Screw Fitting, 0.8 mm ID for AA. Requires but does not include B0172053*	N0777434
PTFE Flame Sampling Probe Assembly with Carbon Fiber Support and Male Screw Fitting, 1.0 mm ID for FIAS*	N2024131

*Keep spare ferrules on hand, **N8145237** Qty. 10



Part No. **B3000152**

Sampling Probe Assembly Components

Description	Part No.
Stainless Steel Sampling Probe with Screw Fitting Requires, but does not include, one of the capillary tubing assemblies described below:	B3000152
Flame Capillary Tubing Assembly 1 m Length, 0.6 mm ID, One Fitting (Red)	B3000157
FIAS Capillary Tubing Assembly 1 m Length, 0.6 mm ID, Two Fittings (Red)	B3000158
FIAS Capillary Tubing Assembly 1 m Length, 1.0 mm ID, Two Fittings (Blue)	B0191060
Corrosion-Resistant Probe only 0.6 mm	B3000055
Corrosion-Resistant Probe only 1.0 mm	B3001769
O-Ring to Hold Probe	B0172053
Probe Holder (White Plastic)	B3000151

PerkinElmer Autosampler Supplies



PerkinElmer AS-93plus/S10 Sample Racks

Description/Capacity	Sample Vessel Size	Part No.
Tray F – 9/29* ¹	50 mL/15 mL	B3001647
Tray E – 90 ²	4.5 mL, 6 mL, 8 mL	B3140617
Tray H and Tray F – 60 ³	15 mL, 16 mL	B3140618
Tray E, H and Tray G – 21 ⁴	50 mL	B3140621

* AS-93plus/S10 sample trays are polypropylene.

¹ Rack **B3001647** (rinsing-port rack) with rinsing port location (location 0), 8 locations for 50 mL solution containers (calibration and/or test sample solutions) and 29 locations for 15 mL solution containers (test sample solutions)

² Rack **B3140617** each with 90 locations for 6 mL and 8 mL solution containers (test sample solutions)

³ Rack **B3140618** with 60 locations for 15 mL solution containers (test sample solutions)

⁴ Rack **B3140621** with 21 locations each for 50 mL solution containers (calibration and/or test sample solutions). Location 0 in the first rack is for the rinsing port

PerkinElmer AS-90/90A/90plus Sample Racks

Description/Capacity	Sample Vessel Size	Part No.
Tray A – 144	4.5 mL, 6 mL, 8 mL	B3000133
Tray B – 98*	15 mL, 16 mL	B3000132
Blank Tray		B0501056

* Polypropylene sample tray

PerkinElmer AS-91 Sample Racks

Description/Capacity	Sample Vessel Size	Part No.
Tray E – 218	4.5 mL, 6 mL, 8 mL	B0509554
8 – 50 mL Spots and Tray F – 152 / 8 (160)	15 mL, 16 mL	B0509555
Tray G – 55	50 mL	B0508520

Trays A, C, E, F and G are powder-coated, corrosion-resistant aluminum

PerkinElmer AS-93plus/S10 Rinsing Kit

Description/Capacity	Part No.
AS-93plus/S10 Rinsing Kit	B3140236
Spare Parts	
Rinsing Port	B3140622
Adapter M	B0507919
Pump Tube – 2.79 mm ID (Pkg. 6) Purple/White	B3140721
Pump Tube – 1.14 mm ID (Pkg. 6)	B3140730
Tygon® Drain Tube – 2 m Red/Red/Red	B0018283
PVC Rinse Liquid Feed Tube – 1 m	B0048139
Connector	B3140715

Cetac Autosampler Supplies



Cetac Carbon Fiber Autosampler Probes

Description	Part No.
0.5 mm Blue 0.5 mm ID x 108 in. – PTFE	N0777547
1.0 mm 2 Blue 1.0 mm ID x 75 in. – PTFE	N0777568



Cetac Ultem Autosampler Probes

Description	Part No.
0.5 mm Blue 0.5 mm ID x 108 in. – PTFE	N0774088
1.0 mm 2 Blue 1.0 mm ID x 75 in. – PTFE	N0777565



Cetac Stainless Steel Autosampler Probe

Description	Part No.
Steel Probe with Screen Tip (100 mesh) Designed for Oil Analysis	N0771529

Cetac Autosampler Racks

Rack	Vial Size	Part No.
21-Position, 30.5 mm Square Opening	50 mL	N0777152
24-Position, 25.2 mm Square Opening	30 mL	N0777151
40-Position, 20.6 mm Square Opening	20 mL	N0777150
30-Position Tall Rack, Square Opening	14 mL	N0777062
40-Position/Gilson 29	20 mL	N0777155
45-Position/120 cc Round Opening (Oils)		N0777298
60-Position, 17.0 mm Square Opening	14 mL or 15 mL	N0777149
80-Position, Collection Metal for Oil	15 mL	N0774085
90-Position, Round Opening	2 mL	N0777717
90-Position, 13.5 mm Square Opening	7 mL or 8 mL	N0777148
90-Position, 13.3 mm Round Opening	7 mL or 8 mL	N0777153
90-Position, 13 mm Collection Metal for Oil	8 mL	N0777154
96-Position, 13 mm Collection Metal for Oil	15 mL	N0777368

ESI Autosampler Supplies



ESI Autosampler Probes

Description	Part No.
Carbon Fiber Autosampler Probes for ST Nebulizers	
Autosampler Probe, 0.15 mm, Capillary Length 80 cm	N0777221
Autosampler Probe, 0.2 mm, Capillary Length 80 cm	N0777222
Autosampler Probe, 0.25 mm, Capillary Length 80 cm	N0777223
Autosampler Probe, 0.25 mm, Capillary Length 150 cm	N0777826
Autosampler Probe, 0.3 mm, Capillary Length 80 cm	N0777224
Autosampler Probe, 0.5 mm, Capillary Length 80 cm	N0777225
Autosampler Probe, 0.5 mm, Capillary Length 150 cm	N0777827
Autosampler Probe, 0.8 mm, Capillary Length 80 cm	N0777226
Sample Probes	
High Flow, Carbon Fiber Support, 0.8 mm ID (Blue)	N0777285
Sample Probe Line Holder	N0777227
Carrier Probes	
High Flow, Carbon Fiber Support, 0.5 mm ID (Orange)	N0777286

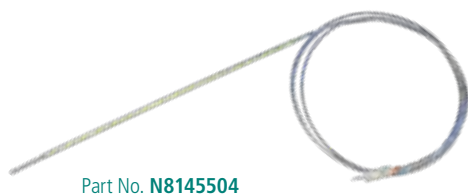

Additional ESI Autosampler Probes

Description	Part No.
PFA <i>FAST</i> Sample Probe for High-flow <i>FAST</i> Valve, 1.0 mm ID (Gray), 150 cm	N0777522
PFA <i>FAST</i> Sample Probe for High-flow <i>FAST</i> Valve, 0.8 mm ID (Blue), 150 cm	N0777523
PFA <i>FAST</i> Carrier / Probe <i>FAST</i> Valve, 0.5 mm ID (Orange), 150 cm	N0777286
PFA Internal Standard Probe for use with Standard Addition Tee 0.5 mm ID (Orange), 150 cm	N8145344
Sample Probe with Ultem Support, 0.5 mm ID (Orange). Includes Fluoropolymer Micro Fitting	N8145504
Internal Standard Probe with Carbon Fiber Support for NexION 2000, 0.5 mm ID (Orange), 150 cm. Includes Fluoropolymer Micro Fitting	N8152452

PFA MicroFlow Nebulizers with Integrated Autosampler Probes (carbon fiber support)

ICP Model	Description	Part No.
Optima/Avio/NexION 350	PFA-20 PFA, Capillary Length 80 cm	N0777214
NexION 1000/2000	PFA-20 PFA, Capillary Length 80 cm	N8152587
Optima/Avio/NexION 350	PFA-50 PFA, Capillary Length 80 cm	N0777215
NexION 1000/2000	PFA-50 PFA, Capillary Length 80 cm	N8152588
Optima/Avio/NexION 350	PFA-100 PFA, Capillary Length 100 cm	N0777216
NexION 1000/2000	PFA-100 PFA, Capillary Length 100 cm	N8152589
Optima/Avio/NexION 350	PFA-200 PFA, Capillary Length 100 cm	N0777217
NexION 1000/2000	PFA-200 PFA, Capillary Length 100 cm	N8152590
Optima/Avio/NexION 350	PFA-400 PFA, Capillary Length 100 cm	N0777218
NexION 1000/2000	PFA-400 PFA, Capillary Length 100 cm	N8152591

PFA MicroFlow Nebulizers with Integrated Autosampler Probes (Ultem Support)

ICP Model	Description	Part No.
Optima/Avio/NexION 350	PFA-20 PFA, Capillary Length 100 cm	N8145141
NexION 1000/2000	PFA-20 PFA, Capillary Length 100 cm	N8152592
Optima/Avio/NexION 350	PFA-50 PFA, Capillary Length 100 cm	N8145142
NexION 1000/2000	PFA-50 PFA, Capillary Length 100 cm	N8152593
Optima/Avio/NexION 350	PFA-100 PFA, Capillary Length 100 cm	N8145143
NexION 1000/2000	PFA-100 PFA, Capillary Length 100 cm	N8152594
Optima/Avio/NexION 350	PFA-200 PFA, Capillary Length 100 cm	N8145144
NexION 1000/2000	PFA-200 PFA, Capillary Length 100 cm	N8152420
Optima/Avio/NexION 350	PFA-400 PFA, Capillary Length 100 cm	N8145275
NexION 1000/2000	PFA-400 PFA, Capillary Length 100 cm	N8152595

ESI Autosampler Racks and Rack Covers



Part No. **N8145131**



Part No. **N0777231**



Part No. **N0777822**

Description	Size	Diameter	Part No.
Standard Racks			
5-Position Priority Samples Rack for 8 mL, 15 mL, 50 mL, 125 mL and 250 mL Bottles. Fits over DX Rinse Station		60 mm	N8145317
5-Position Extra Standards Rack for 3x 50mL Tubes and 2x 250 mL Bottles. Fits over DX Rinse Station		60 mm	N0782019
7-Position for 250 mL Bottles. For 4DX Autosampler only		60 mm	N8122464
9-Position for 125 mL Bottles. Recommended for prepFAST. For 4DX Autosampler only		50 mm	N0777771
9-Position for 125 mL Bottles. Recommended for prepFAST. For 2DX Autosampler only		50 mm	N0777772
10-Position Standards Rack for 20 mL and 50 mL Tubes		28 mm	N0777228
10-Position for 30 mL and 60 mL Tubes		31 mm	N8145131
Micro Racks			
10-Position Micro Sample Rack for 15 mL and 30 mL Tubes		30 mm	N8122463
10-Position for Gemetec/Cetac ASX-100's Racks	2 x 5	61 mm	N0777253
21-Position	3 x 7	14 mm	N0777229
24-Position	4 x 6	14 mm	N0777234
40-Position	4 x 10	14 mm	N0777230
60-Position	5 x 12	8 mm	N0777231
90-Position	5 x 12	8 mm	N0777232
Adapter Plate to adapt Gemetec Rack to ESI DX Autosampler			N0777235
Cover for Micro Racks			N0777233
Large Racks			
21-Position for 50 mL and 60 mL Tubes	3 x 7	30 mm	N0777242
21-Position for 50 mL and 60 mL Tubes – Metal		30 mm	N0777641
40-Position	4 x 10	20 mm	N0777243
60-Position for 15 mL Tubes – Metal		16 mm	N0777642
60-Position	5 x 12	16 mm	N0777244
90-Position for 8 mL Tubes – Metal		13 mm	N0777643
90-Position 3 Tier for 8 mL Tubes – Metal		13 mm	N0777644
90-Position	6 x 15	13 mm	N0777245

Description	Size	Diameter	Part No.
Super Racks			
12-Position for 125 mL Bottles. For 2DX Autosampler only	2 x 6	50 mm	N0777252
15-Position Super Sample Rack for 250 mL Bottles. For 4DX Autosampler only		60 mm	N0777823
20-Position Super Sample Rack for 125 mL Bottles. For 4DX Autosampler only		50 mm	N0777822
21-Position. For 2DX Autosampler only	3 x 7	22 mm	N0777251
21-Position. For 2DX Autosampler only	3 x 7	28 mm	N0777250
21-Position. For 2DX Autosampler only	3 x 7	30 mm	N0777249
27-Position. For 2DX Autosampler only	3 x 9	28 mm	N0777248
27-Position Super Sample Rack for 30 mL and 60 mL Tubes. For 2DX Autosampler only		31 mm	N8145130
60-Position Super Sample Rack for 1 mL, 2 mL and 4 mL Tubes. For 2DX and 4DX Autosamplers		14 mm	N0777397
Cover for 60-Position Super Rack			N0777398
80-Position. For 2DX Autosampler only	5 x 16	16 mm	N0777247

Microtiter Plates

Description	Qty.	Part No.
24 Well, 10 mL, Square Well, Pyramid Bottom	5	N0777236
48 Well, 5 mL, Square Well, Pyramid Bottom	5	N0777237
48 Well, 7.5 mL, Square Well, Pyramid Bottom	3	N0777238
96 Well, 500 µL, Polystyrene	2	N8145354
96 Well, 2 mL, Square Well, Pyramid Bottom	5	N0777239
X-Piercing Film Cover for 96 Well Microtiter Plate	25	N8145129



Part No. **N0777639**

Heated Racks

Description	Size	Part No.
21-Position for 50 mL and 60 mL Tubes – Heated	30 mm	N0777639
60-Position for 15 mL Tubes – Heated	16 mm	N0777640

Autosampler Tubes

PerkinElmer translucent polypropylene tubes are designed to provide excellent chemical resistance. PerformR™ 15 mL and 50 mL conical tubes are designed for your routine everyday applications and storage needs. SuperClear™ tubes are made from a unique medical grade resin.



Round Bottom Tubes



Description	Type	Size	Pack	Qty	Part No.
5 mL without Caps	Standard	12 mm x 75 mm	Bulk	500	B0193235
8 mL without Caps	Standard	13 mm x 100 mm	Bulk	1200	N0777156
8 mL without Caps	Standard	13 mm x 100 mm	250/Bag	1000	N0777159
8 mL without Caps	Standard	13 mm x 100 mm	Bulk	1000	B0508901
14 mL without Caps	Standard	17 mm x 100 mm	Bulk	1000	N0777940
14 mL with Dual-Position, Polyethylene Caps Included	Standard	17 mm x 100 mm	Bulk	1000	N0777941
Dual-Position Caps for 14 mL, N0777940 Tubes (Clear) Caps Only	Standard		Bulk	1000	N0777942
14 mL without Caps	Standard	17 mm x 100 mm	250/Bag	1000	N0777168
15 mL without Plugs	Standard	17 mm x 100 mm	Bulk	1200	N0777167
Plugs for 15 mL N0777167 Tubes, (Blue) Plugs Only	Standard		Bulk	1200	N0777599
15 mL Graduated without Plugs	Standard	17 mm x 100 mm	Bulk	2000	N0777099
16 mL without Caps	Standard	17 mm x 100 mm	250/Bag	1000	N9301205

Conical Bottom Tubes with Graduation



Description	Type	Size	Pack	Qty	Part No.
15 mL with Red Flat Caps, (Standard PerkinElmer S10 Tubes)	Standard	17 mm x 120 mm	50/Bag	500	B0193233
15 mL Sterile Tubes, with Teal Flat Caps Attached	Sterile	17 mm x 118 mm	50/Bag	500	N0774095
15 mL Metal Free Sterile Tubes with White Flat Caps	Sterile	17 mm x 118 mm	50/Bag	500	N0776117
15 mL Metal Free Sterile Tubes Racked with White Flat Caps	Sterile	17 mm x 118 mm	25/Rack	500	N0776118
15 mL with Teal Flat Caps Attached	SuperClear	17 mm x 118 mm	50/bag	500	N0777701
15 mL with Teal Flat Caps Attached	SuperClear	17 mm x 118 mm	Racked 50/Bag	500	N0777702
15 mL with Teal Flat Caps Attached	SuperClear	17 mm x 118 mm	Bulk	500	N0777703
15 mL with Teal Flat Caps Attached	SuperClear	17 mm x 118 mm	50/Bag	500	N0777704
15 mL with Teal Flat Caps Attached	SuperClear		Racked 50/Bag	500	N0777705
15 mL with Teal Plug Caps	SuperClear	17 mm x 118 mm	Bulk	500	N0777706
50 mL with Red Flat Caps Attached, (Standard PerkinElmer S10 Tubes), Freestanding	Standard	28 mm x 115 mm	25/Bag	500	B0193234
50 mL with Red Flat Caps Attached	Standard	28 mm x 114 mm	25/Bag	300	N0777901
50 mL with Teal Flat Caps Attached, Freestanding	PerformR	30 mm x 116 mm	50/Bag	500	N0777697
50 mL with Teal Flat Caps Attached, Freestanding	PerformR	30 mm x 116 mm	Bulk	500	N0777698
50 mL with Teal Plug Caps Attached, Freestanding	PerformR	30 mm x 116 mm	50/Bag	500	N0777699
50 mL with Teal Plug Caps Included, Freestanding	PerformR	30 mm x 116 mm	Bulk	500	N0777700
50 mL Sterile Tubes with Teal Flat Caps Attached	Sterile	29 mm x 115 mm	50/Bag	500	N0774096
50 mL Metal Free Sterile Tubes with White Flat Caps	Sterile	29 mm x 115 mm	50/Bag	500	N0776115
50 mL Metal Free Sterile Tubes Racked with White Flat Caps	Sterile	30 mm x 116 mm	25/Rack	500	N0776116
50 mL with Teal Flat Caps Attached	SuperClear	29 mm x 115 mm	50/Bag	500	N0777691
50 mL with Teal Flat Caps Attached	SuperClear	29 mm x 115 mm	Racked 50/Bag	500	N0777692
50 mL with Teal Flat Caps Included	SuperClear	29 mm x 115 mm	Bulk	500	N0777693
50 mL with Teal Plug Caps Attached	SuperClear	29 mm x 115 mm	50/Bag	500	N0777694
50 mL with Teal Plug Caps Attached	SuperClear	29 mm x 115 mm	Racked 50/Bag	500	N0777695
50 mL with Teal Plug Caps Included	SuperClear	29 mm x 115 mm	Bulk	500	N0777696

PFA Sample Vessels



Description	Qty	Part No.
1 mL, 14 mm OD Graduated PFA Micro Vial	10	N0777403
2 mL, 14 mm OD Graduated PFA Micro Vial	10	N0777404
4 mL, 14 mm OD Graduated PFA Micro Vial	10	N0777405
PFA Snap-On Cap for 14 mm Graduated PFA Micro Vials	10	N0777393
PFA Cap with Knob for 14 mm Graduated PFA Micro Vials	10	N0777392
ETFE Tweezers for Removal of PFA Cap with Knob	1	N0777396

PVDF Autosampler Vials



Description	Qty	Part No.
2 mL PVDF Vial	10	N8145473
2 mL PVDF Vial	100	N8145474
2 mL PVDF Vial	1000	N8145475
2 mL Pre-Cleaned PVDF Vial	100	N8145352

PFA Bottles, Vials and Caps



Description	Qty	Part No.
15 mL, 30 mm OD Graduated PFA Vial	10	N8145132
30 mL, 30 mm OD Graduated PFA Vial	10	N8145133
60 mL, 30 mm OD Graduated PFA Vial	10	N8145134
Screw Cap for 30 mm OD Vials	10	N8145105
10 mL, 16 mm OD Graduated PFA Tubes	10	N8145348
PFA Insert Cap for 16 mm PFA Tube, Knurled Grip	10	N8145349
PFA Septum Pierce Cap for 16 mm PFA Tube (PFA-T16), Knurled Grip	10	N8145350
PFA Sheet for Septum Pierce Cap with 16 mm PFA Tube	100	N8145351
PFA Cap for 14 mm Micro Vials	10	N0777402
PFA Cap for 14 mm Micro Vials	100	N8145476
Pre-Cleaned PFA Cap for 14 mm Vials	100	N8145353
20 mL, 28 mm OD PFA Bottle and Cap	5	N0777406
125 mL, 50 mm OD PFA Bottle and Cap with TFM Insert	1	N0777407

Non-PFA Bottles and Vials



Description	Qty	Part No.
20 mL, 20 mm OD Polypropylene Tube with Screw Cap	50	N8145079
20 mL, 20 mm OD Polypropylene Tube with Screw Cap	500	N0777815
8 mL, 13 mm OD Polypropylene Tube with Rounded Bottom	90	N8145125
8 mL, 13 mm OD Polypropylene Tube with Rounded Bottom	500	N0777814
0.5 mL, 8 mm OD Centrifuge Tube	100	N8121043
0.5 mL, 8 mm OD Centrifuge Tube	500	N0777813
4 L, Polypropylene Rinse Container with Filtered Air Inlet	1	N0777258
250 mL, 61 mm OD Polyethylene Wide Mouth Bottle	12	N0777818
250 mL, 61 mm OD Polyethylene Wide Mouth Bottle	100	N0777819
125 mL, 50 mm OD Polyethylene Bottle with Screw Cap	12	N0777820
125 mL, 50 mm OD Polyethylene Bottle with Screw Cap	24	N0777821

Instrument Benches and Accessory Carts



Avio 200/500 Bench
Part No. **N0782060**



NexION 350 Bench with
Optional Monitor Arm



NexION 1000/2000 Bench
Part No. **N8142011**

A Customized Approach

Lab space is precious and it can be a challenge to find room for a new instrument or accessory. To make the transition easier, we've customized every bench we offer for your instrument and accessory configuration, enabling you to use your lab space to its full potential. Whether you're making room for a new instrument or replacing an old system, we have a bench solution for you.

Dimensions (Depth x Width x Height – inches)	Model	Product Line	Part No.
30 x 60 x 34	PinAAcle 500/900	AA	N077783
30 x 35 x 35	Avio 200/500	ICP-OES	N0782060
30 x 60 x 35	Optima Basic	ICP-OES	N0773106
33 x 21	Optional Large Shelf for Optima Basic Bench (Shelf Only)	ICP-OES	N0777930
30 x 60 x 35	Optima Advanced	ICP-OES	N0771725
30 x 35 x 29	NexION 1000/2000 Bench Not Including Vacuum Pump Dolly	ICP-MS	N8142011
	NexION 1000/2000 Vacuum Pump Dolly Only	ICP-MS	N8142012
30 x 60 x 29	NexION 350 Bench Including Vacuum Pump Dolly	ICP-MS	N8141230
	NexION 350 Vacuum Pump Dolly Only	ICP-MS	N8121069
26	Monitor Arm for Optima Advanced or NexION 350 Bench	ICP-OES/ICP-MS	N0771726
32 x 30 x 29	Titan MPS	AA/ICP-OES/ICP-MS	N0777900
16 x 19 x 34	Accessory Cart	Various	N0777784
16 x 22 x 34	Accessory Cart	Various	N0777785

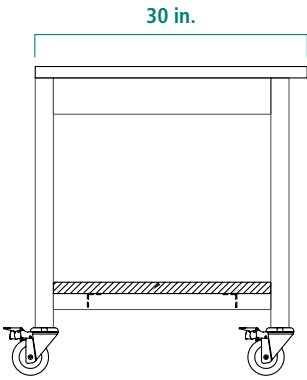

PinAAcle Bench Part No. **N077783**
shown as depth/width/height

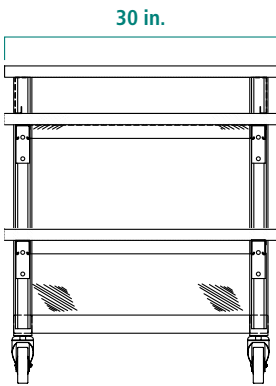
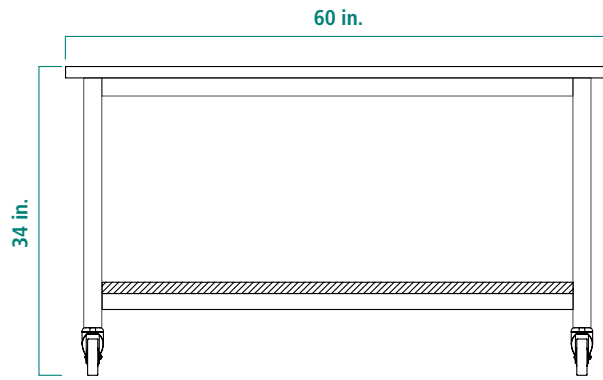

Avio 200/500 Bench Part No. **N0782060**
shown as depth/width/height

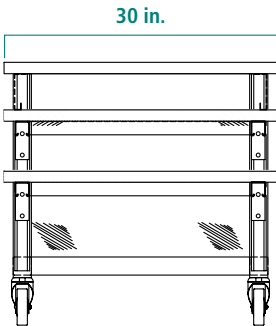
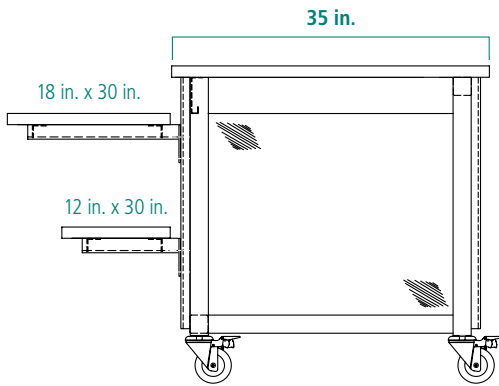

NexION 1000/2000 Bench Part No. **N8142011**
shown as depth/width/height

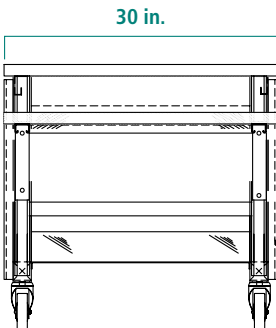
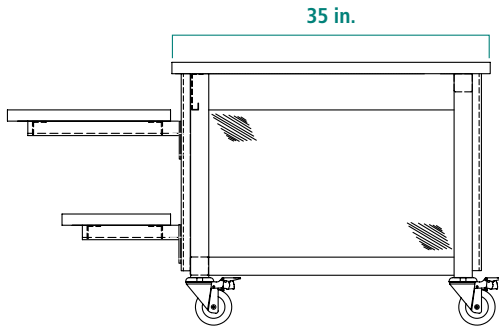

NexION 350 Bench Part No. **N8141230**
shown as depth/width/height

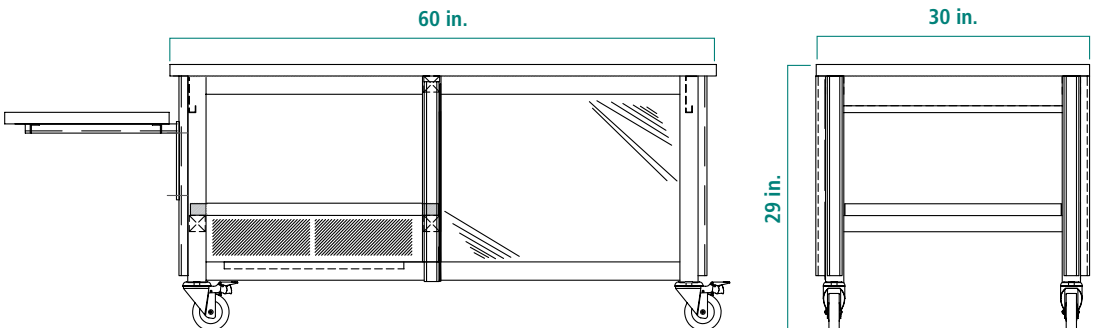

Reference Materials

PerkinElmer offers a complete selection of Atomic Spectroscopy reference materials. Each solution is supplied with a comprehensive Certificate of Analysis that documents the quality and reliability.

Quick Reference Index Page

▶ Aqueous Standards	109-123
▶ Single-Element Standards	109
▶ Custom Standards	112
▶ Matrix Modifiers	112
▶ Multi-Element Standards	113
▶ Environmental Analysis Standards	115
▶ Universal Calibration Standards	121
▶ Pharmaceutical Analysis Standards	122
▶ Gold Nanoparticle Standards	123
▶ Metallo-Organic Standards	124-128
▶ V-21, V-23, V-26 Wear Metal Standards	125
▶ Matrix Oils and Solvents	126
▶ Metal Additive Standards	126
▶ Acid Number Standards	126
▶ Fuel Dilution Standards	126
▶ Base Number Standards	127
▶ Karl Fischer Standards	127
▶ Soot Content Standards	127
▶ OilExpress Standards	127
▶ Viscosity Reference Standards	127
▶ Biodiesel Standards	128
▶ Sulfur Standards	128
▶ Proficiency Testing Standards	128
▶ Single Cell Sample Introduction Kits	129

PerkinElmer is a leading provider of Atomic Spectroscopy solutions. We've used our expertise to bring you a portfolio of the highest quality standards to enhance your instrument performance. From our Pure and Pure Plus Inorganic Aqueous Standards to our Metallo-Organic Standards, inside this guide you will find a range of standards that are certified and tested to provide you the quality and reliability you expect, for all your application needs.

At PerkinElmer, we're committed to helping you achieve success for your laboratory – starting with the standards you use everyday.

Aqueous Standards

PerkinElmer offers a wide selection of PerkinElmer Pure and Pure Plus Aqueous Standards for all of your application needs.



▶ VIEW PAGE

Metallo-Organic Standards

PerkinElmer offers a wide selection of Metallo-Organic Standards for all of your application needs.



▶ VIEW PAGE

Single Cell Sample Introduction Kit

The Single Cell Application Module within PerkinElmer's Syngistix™ for ICP-MS software is the ideal tool for laboratories analyzing metal content in cells, either from bioaccumulation of metals or metallic nanoparticles in solution or measuring the intrinsic metal content of the cell.



▶ VIEW PAGE

Single-Element Standards

We understand how important standards are to your laboratory. That's why we offer a complete selection of PerkinElmer Pure (AA and ICP-OES) and Pure Plus (ICP-MS) grade Standards supplied with a comprehensive Certificate of Analysis. Each solution is certified to provide you with the quality and reliability you expect, every time.

We offer 1 µg/mL, 10 µg/mL, 1,000 µg/mL and 10,000 µg/mL single-element standards in a variety of volumes and purity levels.



Single-Element Standards – 1,000 µg/mL

Element	Symbol	Matrix	Pure Grade 125 mL Part No.	Pure Grade 500 mL Part No.	Pure Plus Grade 125 mL Part No.
Aluminum	Al	2% HNO ₃	N9300184	N9300100	N9303726
Antimony	Sb	2% HNO ₃		N9300101	
Antimony	Sb	H ₂ O/0.6% Tart. Acid/Tr. HNO ₃	N9300207		N9303750
Arsenic	As	2% HNO ₃	N9300180	N9300102	N9303727
Barium	Ba	2% HNO ₃	N9300181	N9300103	N9303729
Beryllium	Be	2% HNO ₃	N9300172	N9300104	N9303730
Bismuth	Bi	10% HNO ₃	N9303761	N9300105	N9303731
Boron	B	H ₂ O	N9303760	N9300106	
Cadmium	Cd	2% HNO ₃	N9300176	N9300107	N9303734
Calcium	Ca	2% HNO ₃	N9303763	N9300108	N9303733
Carbon	C	H ₂ O	N9303762	N9300109	
Cerium	Ce	2% HNO ₃	N9303765	N9300110	
Cesium	Cs	2% HNO ₃	N9303767	N9300111	
Chromium	Cr	2% HNO ₃	N9300173	N9300112	N9303736
Cobalt	Co	2% HNO ₃	N9303766	N9300113	N9303735
Copper	Cu	2% HNO ₃	N9300183	N9300114	N9303737
Dysprosium	Dy	2% HNO ₃	N9303768	N9300115	
Erbium	Er	2% HNO ₃	N9303769	N9300116	
Europium	Eu	2% HNO ₃	N9303770	N9300117	
Gadolinium	Gd	2% HNO ₃	N9303773	N9300118	
Gallium	Ga	2% HNO ₃	N9303772	N9300119	
Germanium	Ge	H ₂ O/0.16% F-	N9303774	N9300120	
Gold	Au	10% HCl	N9303759	N9300121	
Hafnium	Hf	2% HCl	N9303775	N9300122	
Holmium	Ho	2% HNO ₃	N9303776	N9300123	
Indium	In	2% HNO ₃	N9303777	N9300124	
Iridium	Ir	10% HCl	N9303778	N9300125	
Iron	Fe	2% HNO ₃	N9303771	N9300126	N9303738
Lanthanum	La	2% HNO ₃	N9303780	N9300127	
Lead	Pb	2% HNO ₃	N9300175	N9300128	N9303748
Lithium	Li	2% HNO ₃	N9303781	N9300129	
Lutetium	Lu	2% HNO ₃	N9303782	N9300130	
Magnesium	Mg	2% HNO ₃	N9300179	N9300131	N9303743
Manganese	Mn	2% HNO ₃	N9303783	N9300132	N9303744
Mercury	Hg	10% HNO ₃	N9300174	N9300133	N9303740
Molybdenum	Mo	H ₂ O	N9303784	N9300134	N9303745

Element	Symbol	Matrix	Pure Grade 125 mL Part No.	Pure Grade 500 mL Part No.	Pure Plus Grade 125 mL Part No.
Neodymium	Nd	2% HNO ₃	N9303787	N9300135	
Nickel	Ni	2% HNO ₃	N9300177	N9300136	N9303747
Niobium	Nb	H ₂ O/0.4% HF	N9303786	N9300137	
Palladium	Pd	10% HCl	N9303789	N9300138	
Phosphorus	P	H ₂ O	N9303788	N9300139	
Platinum	Pt	10% HCl	N9303791	N9300140	
Potassium	K	2% HNO ₃	N9303779	N9300141	N9303742
Praseodymium	Pr	2% HNO ₃	N9303790	N9300142	
Rhenium	Re	H ₂ O	N9303793	N9300143	
Rhodium	Rh	10% HCl	N9303794	N9300144	
Rubidium	Rb	2% HNO ₃	N9303792	N9300145	
Ruthenium	Ru	10% HCl	N9303795	N9300146	
Samarium	Sm	2% HNO ₃	N9303800	N9300147	
Scandium	Sc	2% HNO ₃	N9303798	N9300148	
Selenium	Se	2% HNO ₃	N9300182	N9300149	N9303752
Silicon	Si	H ₂ O/0.4% F-	N9303799	N9300150	
Silver	Ag	2% HNO ₃	N9300171	N9300151	N9303725
Sodium	Na	2% HNO ₃	N9303785	N9300152	N9303746
Strontium	Sr	2% HNO ₃	N9303802	N9300153	
Sulfur	S	H ₂ O	N9303796	N9300154	
Tantalum	Ta	H ₂ O/0.8% HF	N9303803	N9300155	
Tellurium	Te	10% HNO ₃	N9304385	N9304384	
Terbium	Tb	2% HNO ₃	N9303804	N9300157	
Tin	Sn	20% HCl	N9303801	N9300161	
Tin	Sn	1% HNO ₃ /1% HF			N9303838
Thallium	Tl	2% HNO ₃	N9300170	N9300158	N9303755
Thorium	Th	2% HNO ₃			N9303842
Thulium	Tm	2% HNO ₃	N9303807	N9300160	
Titanium	Ti	H ₂ O/0.24% F-	N9303806	N9300162	N9303754
Tungsten	W	H ₂ O	N9303809	N9300163	
Uranium	U	2% HNO ₃			N9303844
Vanadium	V	2% HNO ₃	N9303808	N9300165	N9303756
Ytterbium	Yb	2% HNO ₃	N9303811	N9300166	
Yttrium	Y	2% HNO ₃	N9303810	N9300167	
Zinc	Zn	2% HNO ₃	N9300178	N9300168	N9303758
Zirconium	Zr	2% HNO ₃	N9303812	N9300169	

Single-Element Pure Plus ICP-MS Grade Standards – 1 µg/mL

Element	Symbol	Matrix	Pure Plus Grade 125 mL Part No.
Aluminum	Al	2% HCl	N9304200
Aluminum	Al	2% HNO ₃	N9304201
Antimony	Sb	5% HCl	N9304202
Antimony	Sb	H ₂ O/Tr. HNO ₃ /Tr. Tart	N9304203
Arsenic	As	2% HCl	N9304204
Arsenic	As	2% HNO ₃	N9304205
Barium	Ba	2% HCl	N9304206
Barium	Ba	2% HNO ₃	N9304207
Beryllium	Be	2% HNO ₃	N9304208
Bismuth	Bi	2% HNO ₃	N9304209
Boron	B	H ₂ O	N9304210
Cadmium	Cd	2% HCl	N9304211
Cadmium	Cd	2% HNO ₃	N9304212
Calcium	Ca	2% HCl	N9304213
Calcium	Ca	2% HNO ₃	N9304214
Carbon	C	H ₂ O	N9304215
Cerium	Ce	2% HNO ₃	N9304216
Cesium	Cs	2% HNO ₃	N9304217
Chromium	Cr	2% HCl	N9304218
Chromium	Cr	5% HNO ₃	N9304219
Chromium	Cr	H ₂ O	N9304220
Cobalt	Co	2% HCl	N9304221
Cobalt	Co	2% HNO ₃	N9304222
Copper	Cu	2% HCl	N9304223
Copper	Cu	2% HNO ₃	N9304224
Dysprosium	Dy	2% HNO ₃	N9304225
Erbium	Er	2% HNO ₃	N9304226
Europium	Eu	2% HNO ₃	N9304227
Gadolinium	Gd	2% HNO ₃	N9304228
Gallium	Ga	2% HNO ₃	N9304229
Germanium	Ge	H ₂ O	N9304230
Gold	Au	1% HNO ₃ /3% HCL	N9304231
Hafnium	Hf	2% HCl	N9304232
Holmium	Ho	2% HNO ₃	N9304233
Indium	In	2% HNO ₃	N9304234
Iridium	Ir	2% HCl	N9304235
Iron	Fe	2% HCl	N9304236
Iron	Fe	2% HNO ₃	N9304237
Lanthanum	La	2% HNO ₃	N9304238
Lead	Pb	2% HNO ₃	N9304239
Lithium	Li	2% HCl	N9304240
Lithium	Li	2% HNO ₃	N9304241
Lutetium	Lu	2% HNO ₃	N9304242
Magnesium	Mg	2% HCl	N9304243
Magnesium	Mg	2% HNO ₃	N9304244
Manganese	Mn	2% HNO ₃	N9304245

Element	Symbol	Matrix	Pure Plus Grade 125 mL Part No.
Mercury	Hg	2% HNO ₃	N9304246
Potassium	K	2% HCl	N9304247
Potassium	K	2% HNO ₃	N9304248
Molybdenum	Mo	H ₂ O	N9304249
Niobium	Nb	H ₂ O/tr HF	N9304250
Neodymium	Nd	2% HNO ₃	N9304251
Nickel	Ni	2% HNO ₃	N9304252
Palladium	Pd	2% HCl	N9304253
Phosphorus	P	H ₂ O	N9304254
Platinum	Pt	2% HCl	N9304255
Praseodymium	Pr	2% HNO ₃	N9304256
Rubidium	Rb	2% HNO ₃	N9304257
Rhenium	Re	H ₂ O	N9304258
Rhodium	Rh	2% HCl	N9304259
Ruthenium	Ru	2% HCl	N9304260
Samarium	Sm	2% HNO ₃	N9304261
Scandium	Sc	2% HNO ₃	N9304262
Selenium	Se	2% HNO ₃	N9304263
Silicon	Si	H ₂ O/Tr. F-	N9304264
Silver	Ag	2% HNO ₃	N9304265
Sodium	Na	2% HCl	N9304266
Sodium	Na	2% HNO ₃	N9304267
Strontium	Sr	2% HCl	N9304268
Strontium	Sr	2% HNO ₃	N9304269
Sulfur	S	H ₂ O	N9304270
Tantalum	Ta	H ₂ O/tr HF	N9304271
Tellurium	Te	5% HCl	N9304272
Tellurium	Te	5% HNO ₃	N9304273
Terbium	Tb	2% HNO ₃	N9304274
Thallium	Tl	2% HNO ₃	N9304275
Thorium	Th	2% HNO ₃	N9304276
Thulium	Tm	2% HNO ₃	N9304277
Tin	Sn	5% HCl	N9304278
Tin	Sn	2% HNO ₃ /tr HF	N9304279
Titanium	Ti	H ₂ O/tr HF	N9304280
Tungsten	W	2% HNO ₃ /tr HF	N9304281
Tungsten	W	H ₂ O	N9304282
Uranium	U	2% HNO ₃	N9304283
Vanadium	V	2% HCl	N9304284
Vanadium	V	2% HNO ₃	N9304285
Ytterbium	Yb	2% HNO ₃	N9304286
Yttrium	Y	2% HNO ₃	N9304287
Zinc	Zn	2% HCl	N9304288
Zinc	Zn	2% HNO ₃	N9304289
Zirconium	Zr	2% HCl	N9304290
Zirconium	Zr	2% HNO ₃	N9304291

Single-Element Pure Plus ICP-MS Grade Standards – 10 µg/mL

Element	Symbol	Matrix	Pure Plus Grade 125 mL Part No.
Bismuth	Bi	2% HNO ₃	N9303731
Germanium	Ge	H ₂ O tr HF	N9303739
Indium	In	2% HNO ₃	N9303741
Rhodium	Rh	2% HCl	N9303749
Scandium	Sc	2% HNO ₃	N9303751
Terbium	Tb	2% HNO ₃	N9303753
Yttrium	Y	2% HNO ₃	N9303757

Single-Element Pure Standards – 10,000 µg/mL

Element	Symbol	Matrix	Pure Plus Grade 125 mL Part No.	Pure Grade 500 mL Part No.
Aluminum	Al	5% HNO ₃	N9304111	N9304110
Antimony	Sb	20% HCl		N9304292
Antimony	Sb	H ₂ O/Tartaric Acid/Tr HNO ₃	N9304293	N9304294
Arsenic	As	5% HNO ₃	N9304295	N9304296
Barium	Ba	5% HNO ₃	N9304297	N9304298
Beryllium	Be	5% HNO ₃	N9304299	N9304300
Boron	B	H ₂ O	N9304301	N9304302
Cadmium	Cd	5% HNO ₃	N9304303	N9304304
Calcium	Ca	5% HNO ₃	N0691581	N9303764
Cerium	Ce	5% HNO ₃	N9304305	N9304306
Cesium	Cs	5% HNO ₃	N9304307	N9304308
Chromium	Cr	5% HNO ₃	N9304309	N9304311
Chromium	Cr	5% HCl		N9304310
Chromium	Cr	H ₂ O		N9304312
Cobalt	Co	5% HNO ₃	N9304313	N9304314
Copper	Cu	5% HNO ₃	N9304112	N9300283
Erbium	Er	5% HNO ₃		N9304315
Gadolinium	Gd	5% HNO ₃	N9304316	N9304317
Iron	Fe	5% HNO ₃	N9304113	N9307117
Lanthanum	La	5% HNO ₃	N9304318	N9304319
Lead	Pb	5% HNO ₃	N9304321	N9304320
Lithium	Li	5% HCl		N9304322
Lithium	Li	5% HNO ₃	N9304323	N9304324
Magnesium	Mg	5% HNO ₃	N0691745	N9304114
Manganese	Mn	5% HNO ₃	N9304115	
Mercury	Hg	10% HNO ₃	N9304325	N9304326
Molybdenum	Mo	H ₂ O/0.4% HF	N9304327	N9304328
Nickel	Ni	5% HNO ₃	N9304117	N9304116
Niobium	Nb	H ₂ O/0.4% HF	N9304330	N9304329
Phosphorus	P	H ₂ O	N9304119	N9304118
Potassium	K	5% HNO ₃	N9304121	N9304120
Rubidium	Rb	2% HNO ₃	N9304331	N9304332
Scandium	Sc	5% HNO ₃	N9304333	N9304334
Selenium	Se	5% HNO ₃	N9304335	N9304336

Pure Grade Standards for AA and ICP-OES

- Analyzed by ICP-OES
- Analyzed by Classical Wet Assay
- 32 trace impurities analyzed by ICP-MS of the final solution and reported on the certificate
- Impurities reported at ppm level
- All Standards are prepared and certified under ISO Guide 34 and ISO 17025



Pure Plus Grade Standards for ICP-MS

- Analyzed by ICP-OES
- Analyzed by Classical Wet Assay
- 67 trace impurities analyzed by ICP-MS of the final solution and reported on the certificate
- Impurities reported at ppb level
- All Standards are prepared and certified under ISO Guide 34 and ISO 17025

Element	Symbol	Matrix	Pure Plus Grade 125 mL Part No.	Pure Grade 500 mL Part No.
Silicon	Si	H ₂ O/4% F-	N9304122	
Silver	Ag	5% HNO ₃	N9304337	N9304338
Sodium	Na	5% HNO ₃	N9304124	N9304123
Strontium	Sr	5% HCl		N9304339
Strontium	Sr	5% HNO ₃	N9304340	N9304341
Sulfur	S	H ₂ O	N9304126	N9304125
Tantalum	Ta	H ₂ O		N9304342
Tantalum	Ta	H ₂ O/0.8% HF	N9304343	
Tin	Sn	2%/HNO ₃ /2% HF		N9304344
Tin	Sn	20% HCl	N9304345	N9304346
Titanium	Ti	40% HCl		N9304347
Titanium	Ti	H ₂ O/2.4% F-	N9304348	N9304349
Tungsten	W	2% HNO ₃ /5% HF		N9304350
Tungsten	W	H ₂ O	N9304351	N9304352
Uranium	U	5% HNO ₃	N9304353	N9304354
Vanadium	V	15% HCl		N9304355
Vanadium	V	15% HNO ₃	N9304356	N9304357
Yttrium	Y	5% HNO ₃	N9304128	N9304127
Zinc	Zn	5% HNO ₃	N9304129	
Zirconium	Zr	10% HCl		N9304358
Zirconium	Zr	5% HNO ₃	N9304359	N9304360

Custom Single and Multi-element Standards for Inorganic Analysis

We understand how important Standards are to your laboratory. That's why we've expanded PerkinElmer Pure and Pure Plus Standards to include custom Standards. We offer a complete selection of stock, single and multi-element, atomic spectroscopy aqueous Standards, and now provide single-element and multi-element custom Standards, prepared to meet your exact specifications. Each solution is supplied with a comprehensive Certificate of Analysis to provide you with the quality and reliability you expect, every time.



Design your own custom standard to fit your laboratory needs.

Choose PerkinElmer as your Standards provider and request your quote today. For a complete selection of Pure Atomic Spectroscopy Standards, please visit www.perkinelmer.com/standards

Custom Standards are now available in North America and select countries in Europe.



You can order Custom Standards online by visiting www.perkinelmer.com/customstandards or over the phone by calling your local PerkinElmer sales office.

Matrix Modifiers and AA Test Mixes

We offer standards specifically for your Atomic Absorption (AA) instrument. From mixed standards to reagents, we have what you need for your AA analysis.



Matrix Modifiers for Graphite Furnace AA

Matrix	Content	Volume	Part No.
Mg(NO ₃) ₂	1% Mg (NO ₃) ₂ (as nitrate)	100 mL	B0190634
Pd	1% Pd (as nitrate)	50 mL	B0190635
NH ₄ H ₂ PO ₄	10% NH ₄ H ₂ PO ₄	100 mL	N9303445

GFAAS Mixed Standard

Matrix	Content	Volume	Part No.
5% HNO ₃ with trace HF	100 µg/mL: Al, As, Pb, Sb, Se, Tl 50 µg/mL: Ba, Co, Cu, Ni 20 µg/mL: Cr, Fe, Mn 10 µg/mL: Ag 5 µg/mL: Be, Cd	125 mL	N9300244

AA Test Mix

Matrix	Content	Volume	Part No.
2% HCl	50 µg/mL: Ca, Cr, Cu, Fe, Ni 20 µg/mL: K 10 µg/mL: Na, Zn	125 mL	02900540

Reagents

Description	Volume	Part No.
Triton® X-100 Wetting Agent	100 mL	N9300260
Antifoaming Silicone Emulsion	500 mL	B0507226
Glycerol	1 L	B3141064

Multi-Element Standards

Our go-to multi-element standards are suitable for your daily laboratory needs. Spanning across a wide range of applications and methods, you'll find the right solution to help you achieve laboratory success.

Multi-Element Standards

Matrix	Content	Volume	Part No.
Multi-Element Solution			
5% HNO ₃	1,000 µg/mL: Al, Ca, Fe, Mg	500 mL	N9307113
Multi-Element Solution			
5% HNO ₃	1,000 µg/mL: K, Na, P	500 mL	N9307114
Multi-Element Solution			
2-5% HNO ₃	1,000 µg/mL: Mo, Sb, Sn, W, Zr	500 mL	N9307115
Multi-Element Solution			
5% HNO ₃	1,000 µg/mL: As, Ba, Be, Cd, Cr, Co, Cu, La, Pb, Li, Mn, Ni, Sc, Sr, V, Y, Zn	500 mL	N9307116
5% HNO ₃ /trace HF	100 µg/mL: Ge, Mo, S, Si, Ti	125 mL	N9308541
20% HCl/1% HNO ₃	100 µg/mL: Au, Cr, Sb, Sn, Te	125 mL	N9308542
5% HNO ₃	100 µg/mL: Ag, As, B, Ba, Be, Bi, Ca, Cd, Co, Cu, Fe, K, Li, Mg, Mn, Na, Ni, P, Pb, Se, Sr, Ti, U, V, Zn	125 mL	N9308543
Multi-Element Solution 1			
2% HNO ₃	10 µg/mL: Be, Bi, Ce, Co, In, Mg, Ni, Pb, U	125 mL	N9300231
Multi-Element Solution 2			
5% HNO ₃	10 µg/mL: Ce, Dy, Er, Eu, Gd, Ho, La, Lu, Nd, Pr, Sc, Sm, Tb, Th, Tm, Y, Yb	125 mL	N9300232
Multi-Element Solution 3			
5% HNO ₃	10 µg/mL: Ag, Al, As, Ba, Be, Bi, Ca, Cd, Co, Cr, Cs, Cu, Fe, Ga, Hg*, In, K, Li, Mg, Mn, Na, Ni, Pb, Rb, Se, Sr, Ti, U, V, Zn <small>*Supplied in separate bottle.</small>	125 mL	N9300233
Multi-Element Solution 3 without Mercury			
		125 mL	N9301720
Multi-Element Solution 4			
10% HCl/1% HNO ₃	10 µg/mL: Au, Hf, Ir, Pd, Pt, Rh, Ru, Sb, Sn, Te	125 mL	N9300234
Multi-Element Solution 5			
H ₂ O/trace HF/trace HNO ₃	10 µg/mL: B, Ge, Mo, Nb, P, Re, S, Si, Ta, Ti, W, Zr	125 mL	N9300235
Set of Multi-Element Solutions Includes: (1 bottle of each)			N9300236
	Multi-Element Solution 2	125 mL	N9300232
	Multi-Element Solution 3	125 mL	N9300233
	Multi-Element Solution 4	125 mL	N9300234
	Multi-Element Solution 5	125 mL	N9300235
	Water Blank	125 mL	N9303814
	Hydrochloric Acid Blank	125 mL	N9300238
	2% Nitric Acid Blank	125 mL	N9300239

Matrix	Content	Volume	Part No.
PerkinElmer Pure I			
5% HNO ₃	400 µg/mL: Tl 200 µg/mL: Bi, In, Pb 150 µg/mL: Ga 100 µg/mL: Al 50 µg/mL: Ag, Ni 25 µg/mL: Cr 20 µg/mL: Cd, Co, Cu, Zn 15 µg/mL: B, Fe 5 µg/mL: Ba, Mn 1 µg/mL: Be, Sr	125 mL	N9303940
PerkinElmer Pure IV (Quality Control Standard 23)			
10% HNO ₃	1,000 µg/mL: Ag, Al, B, Ba, Bi, Ca, Cd, Co, Cr, Cu, Fe, Ga, In, K, Li, Mg, Mn, Na, Ni, Pb, Sr, Ti, Zn	125 mL	N9303941
PerkinElmer Pure VIII			
5% HNO ₃	100 µg/mL: Al, B, Ba, Be, Bi, Ca, Cd, Co, Cr, Cu, Fe, Ga, K, Li, Mg, Mn, Na, Ni, Pb, Se, Sr, Te, Ti, Zn	125 mL	N9303942
PerkinElmer Pure IX			
5% HNO ₃	100 µg/mL: As, Be, Pb, Cd, Cr, Ni, Se, Ti	125 mL	N9303943
PerkinElmer Pure X			
2% HNO ₃	35,000 µg/L: Ca 15,000 µg/L: Mg 8,000 µg/L: Na 3,000 µg/L: K 100 µg/L: B, Fe, Mo, Sr 50 µg/L: As, Ba, Ni, V, Zn 30 µg/L: Mn 25 µg/L: Co, Pb 20 µg/L: Be, Cd, Cr, Cu 10 µg/L: Bi, Se, Ti	125 mL	N9303944
8 µg/mL Mercury in 5% HNO₃			
5% HNO ₃	8 µg/mL: Hg	125 mL	N9303954
PerkinElmer Pure XI			
5% HNO ₃	2,500 µg/mL: Zn 900 µg/mL: Cr, Pb 800 µg/mL: Cu 200 µg/mL: Ni 10 µg/mL: Cd	125 mL	N9303945
5 µg/mL Mercury in 5% HNO₃			
5% HNO ₃	5 µg/mL: Hg	125 mL	N9303949
PerkinElmer Pure XIII			
5% HNO ₃	500 µg/mL: Al 250 µg/mL: V 100 µg/mL: As, Be, Co, Cr, Cu, Fe, Mn, Ni, Pb, Zn 25 µg/mL: Cd, Se	125 mL	N9303946

Multi-Element Standards Continued

Matrix	Content	Volume	Part No.
PerkinElmer Pure XVI (Quality Control Standard, 21 Elements)			
5% HNO ₃ /trace Tartaric Acid/trace HF	100 µg/mL: As, Be, Ca, Cd, Co, Cr, Cu, Fe, Li, Mg, Mn, Mo, Ni, Pb, Sb, Se, Sr, Ti, Tl, V, Zn	125 mL	N9300281
PerkinElmer Pure XVII			
15% HCl/trace HF	100 µg/mL: Hf, Ir, Sb, Sn, Ta, Tl, Zr	125 mL	N9303948
PerkinElmer Pure VI			
1 mol/L HNO ₃ /trace Tartaric Acid	10 µg/mL: Ag, Al, Ba, Bi, Cd, Co, Cr, Cu, Ga, K, Li, Mg, Mn, Mo, Na, Ni, Pb, Rb, Sr, Te, Tl, U, V, 100 µg/mL: As, B, Be, Fe, Se, Zn, 1000 µg/mL: Ca	125 mL	N9307741
Multi-Element Standard			
10% HNO ₃	100 µg/mL: As, Ba, Ca, Cd, Be, Bi, Ce, Cs, Cr, Co, Cu, Dy, Er, Eu, Gd, Ga, Ho, In, La, Pb, Li, Lu, Mn, Nd, Ni, Pr, Rb, Sm, Sc, Se, Sr, Tb, Tl, Th, Tm, U, V, Yb, Y, Zn	125 mL	N9308544
Multi-Element Standard A			
5% HNO ₃ /1% HF/trace Tartaric Acid	100 µg/mL: Ge, Hf, Mo, Nb, Sb, Sn, Ta, Te, Ti, W, Zr	125 mL	N9308545
Multi-Element Standard B			
10% HNO ₃	10,000 µg/mL: Ca, K, Mg, Na, P	125 mL	N9308546
Multi-Element Standard C			
5% HNO ₃	10,000 µg/mL: Al, Fe	125 mL	N9308547
Multi-Element Standard D			
5% HCl	10 µg/mL: Au, Pd, Pt	125 mL	N9308548
Multi-Element Standard E			
5% HNO ₃	10 µg/mL: Ag, Hg	125 mL	N9308549

Quality Control Standards

Matrix	Content	Volume	Part No.
Quality Control Standard 1A			
5% HNO ₃ /trace Tartaric Acid HF	1,000 µg/mL: Sb, Ti	125 mL	N9304130
Quality Control Standard 1B			
10% HNO ₃	1,000 µg/mL: As, Be, Ca, Cd, Co, Cr, Cu, Fe, Li, Mg, Mn, Mo, Ni, Pb, Se, Sr, Ti, Tl, V, Zn	125 mL	N9304131
Quality Control Standard, 21 Elements Pure (Pure XVI)			
5% HNO ₃ /trace Tartaric Acid/trace HF	100 µg/mL: As, Be, Ca, Cd, Co, Cr, Cu, Fe, Li, Mg, Mn, Mo, Ni, Pb, Sb, Se, Sr, Ti, Tl, V, Zn	125 mL	N9300281
Quality Control Standard, 21 Elements Pure Plus			
5% HNO ₃ /trace Tartaric Acid/trace HF	100 µg/mL: As, Be, Ca, Cd, Co, Cr, Cu, Fe, Li, Mg, Mn, Mo, Ni, Pb, Sb, Se, Sr, Ti, Tl, V, Zn	125 mL	N9303837
Quality Control Standard, 7A Elements			
5% HNO ₃ /trace HF	1,000 µg/mL: K 500 µg/mL: Si 100 µg/mL: Al, B, Ba, Na 50 µg/mL: Ag	125 mL	N9300280

Mixed Calibration Standards

Matrix	Content	Volume	Part No.
Mixed Calibration Standard			
2% HNO ₃	50 µg/mL: As, K 10 µg/mL: La, Li, Mn, Ni, Sr, Zn 1 µg/mL: Ba, Mg	500 mL	N0691579
Mixed Calibration Standard 1			
2% HNO ₃	500 µg/mL: Pb 200 µg/mL: Se 150 µg/mL: Cd, Zn 100 µg/mL: Mn 50 µg/mL: Be	125 mL	N9300200
Mixed Calibration Standard 2			
5% HNO ₃	10,000 µg/mL: Fe 100 µg/mL: Ba, Co, Cu, V	125 mL	N9300201
Mixed Calibration Standard 3			
2% HNO ₃ /Tr. HF	500 µg/mL: As 100 µg/mL: Mo, Si	125 mL	N9300202
Mixed Calibration Standard 4			
5% HNO ₃	1,000 µg/mL: Ca 400 µg/mL: K 200 µg/mL: Al, Na 20 µg/mL: Cr, Ni	125 mL	N9300203
Mixed Calibration Standard 5			
5% HNO ₃ /trace Tartaric Acid/trace HF	1,000 µg/mL: Mg 200 µg/mL: Sb, Tl 100 µg/mL: B 50 µg/mL: Ag	125 mL	N9300204

Spike Standards

Matrix	Content	Volume	Part No.
Spike Sample Standard I			
5% HNO ₃ /trace Tartaric Acid/trace HF	200 µg/mL: Al, As, Ba, Se, Tl 100 µg/mL: Fe 50 µg/mL: Co, Mn, Ni, Pb, Sb, V, Zn 25 µg/mL: Cu 20 µg/mL: Cr 5 µg/mL: Ag, Be, Cd	125 mL	N9300230
Spike Sample Standard I (Water)			
5% HNO ₃ /trace Tartaric Acid/trace HF	500 µg/mL: Fe 250 µg/mL: Ba, Zn 100 µg/mL: Co, Cr, Cu, Mn, Ni, Sb, V 50 µg/mL: As, Pb 25 µg/mL: Ag, Be, Cd, Se, Tl	125 mL	N9303839
Spike Sample Standard 2 (Soil)			
5% HNO ₃ /trace Tartaric Acid/trace HF	250 µg/mL: Ba, Cr, Cu, Zn 150 µg/mL: V 125 µg/mL: Ni 100 µg/mL: Co, Pb, Sb 50 µg/mL: As, Cd 25 µg/mL: Ag, Be, Se, Tl	125 mL	N9303840
Spike Sample Standard 3 (for ILM 05.2)			
5% HNO ₃ /trace Tartaric Acid/trace HF	200 µg/mL: Al, Ba 50 µg/mL: Co, Mn, Ni, V, Zn 25 µg/mL: Cu 20 µg/mL: Cr 10 µg/mL: Sb 5 µg/mL: Ag, Be, Cd, Tl 4 µg/mL: As 2 µg/mL: Pb 1 µg/mL: Se	125 mL	N9303841

Environmental Analysis Standards

We offer a variety of environmental analysis standards for all your environmental application needs.

Environmental Method Sets

Matrix	Content	Volume	Part No.
Environmental Standard Kit for NexION Standard Mode Includes 1 bottle of each:			
5% HNO ₃	1,000 µg/mL: Ca, K, Mg, Na	125 mL	N9307805
5% HNO ₃	1,000 µg/mL: Al, Fe	125 mL	N9307806
5% HNO ₃ /trace Tartaric Acid/trace HF	100 µg/mL: Ag, Al, As, Ba, Be, Ca, Cd, Co, Cr, Cu, Fe, K, Mg, Mn, Mo, Na, Ni, Pb, Sb, Se, Sn, Sr, Ti, Tl, V, Zn	125 mL	N9301721
2% HNO ₃	100 µg/mL: B, Th, U	125 mL	N9307807
5% HNO ₃	10 µg/mL: Hg	125 mL	N9300253
2% HNO ₃	50 µg/mL: Sc, Ge 10 µg/mL: Rh, In, Tb	125 mL	N9308591
Environmental Standard Kit for NexION KED/DRC Mode Includes 1 bottle of each:			
5% HNO ₃	1,000 µg/mL: Ca, K, Mg, Na	125 mL	N9307805
5% HNO ₃	1,000 µg/mL: Al, Fe	125 mL	N9307806
5% HNO ₃ /trace Tartaric Acid/trace HF	100 µg/mL: Ag, Al, As, Ba, Be, Ca, Cd, Co, Cr, Cu, Fe, K, Mg, Mn, Mo, Na, Ni, Pb, Sb, Se, Sn, Sr, Ti, Tl, V, Zn	125 mL	N9301721
2% HNO ₃	100 µg/mL: B, Th, U	125 mL	N9307807
5% HNO ₃	10 µg/mL: Hg	125 mL	N9300253
2% HNO ₃	100 µg/mL: Sc 50 µg/mL: Ge 1 µg/mL: Rh, In, Tb	125 mL	N9308592
Environmental Standard Kit for ELAN non-DRC/Standard ICP-MS Instruments Includes 1 bottle of each:			
5% HNO ₃	1,000 µg/mL: Ca, K, Mg, Na	125 mL	N9307805
5% HNO ₃	1,000 µg/mL: Al, Fe	125 mL	N9307806
	100 µg/mL: Ag, Al, As, Ba, Be, Ca, Cd, Co, Cr, Cu, Fe, K, Mg, Mn, Mo, Na, Ni, Pb, Sb, Se, Sn, Sr, Ti, Tl, V, Zn	125 mL	N9301721
2% HNO ₃	100 µg/mL: B, Th, U	125 mL	N9307807
5% HNO ₃	10 µg/mL: Hg	125 mL	N9300253
Internal Standard Mix			
5% HNO ₃ /trace HCL	50 µg/mL: Sc 20 µg/mL: Ge 10 µg/mL: In, Ir, Li6, Rh, Tb, Y	125 mL	N9307808

Matrix	Content	Volume	Part No.
Environmental Standard Kit for ELAN DRC Instruments Includes 1 bottle of each:			
5% HNO ₃	1,000 µg/mL: Ca, K, Mg, Na	125 mL	N9307805
5% HNO ₃	1,000 µg/mL: Al, Fe	125 mL	N9307806
5% HNO ₃ /trace Tartaric acid/trace HF	100 µg/mL: Ag, Al, As, Ba, Be, Ca, Cd, Co, Cr, Cu, Fe, K, Mg, Mn, Mo, Na, Ni, Pb, Sb, Se, Sn, Sr, Ti, Tl, V, Zn	125 mL	N9301721
2% HNO ₃	100 µg/mL: B, Th, U	125 mL	N9307807
5% HNO ₃	10 µg/mL: Hg	125 mL	N9300253
5% HNO ₃ /trace HCl	Internal Standard Mix 200 µg/mL: Sc 20 µg/mL: Ga 10 µg/mL: In, Ir, Rh, Tm	125 mL	N9307738
Contract Lab Program Modification Set Includes 1 bottle of each:			
2% HNO ₃ /5% HCl	10 µg/mL: Ba, Be, Ce, Co, In, Li, Mg, Pb, Rh, Tl, U, Y	125 mL	N9303843
2% HNO ₃ /trace Tartaric Acid	20 µg/mL: Ag, Al, As, Ba, Be, Cd, Co, Cr, Cu, Mn, Mo, Ni, Pb, Sb, Se, Th, Tl, U, V, Zn	125 mL	N9303816
5% HNO ₃ /trace Tartaric Acid/trace HF	100 µg/mL: Ag, Al, As, Ba, Be, Ca, Cd, Co, Cr, Cu, Fe, K, Mg, Mn, Mo, Na, Ni, Pb, Sb, Se, Sn, Sr, Ti, Tl, V, Zn	125 mL	N9301721
5% HNO ₃ /trace Tartaric Acid	500 µg/mL: Ca, K, Mg, Na 20 µg/mL: Al, Ba 10 µg/mL: Fe 6 µg/mL: Sb 5 µg/mL: Co, V 4 µg/mL: Ni 2.5 µg/mL: Cu 2 µg/mL: Zn 1.5 µg/mL: Mn 1 µg/mL: Ag, As, Cr, Tl 0.5 µg/mL: Be, Cd, Se 0.3 µg/mL: Pb	125 mL	N9303819
2% HNO ₃ /trace Tartaric Acid/trace HF	10 µg/mL: Ag, Al, As, Ba, Be, Cd, Co, Cr, Cu, Mn, Ni, Pb, Sb, Se, Tl, V, Zn	125 mL	N9303821
5% HNO ₃	10 µg/mL: Hg	125 mL	N9300253
2% HNO ₃	200 µg/mL: Ca, Fe, K, Mg, Na	125 mL	N9303822
2% HNO ₃	10 µg/mL: Mo, Th, U	125 mL	N9303823
2% HNO ₃ /trace HF	10 µg/mL: Mo, Sn, Sr, Ti	125 mL	N9303824
5% HNO ₃ /trace HF	21,215 µg/mL: Cl 3,000 µg/mL: Ca 2,500 µg/mL: Fe, Na 2,000 µg/mL: C 1,000 µg/mL: Al, K, Mg, P, S 20 µg/mL: Mo, Ti	125 mL	N9303827
2% HNO ₃	20 µg/mL: Co, Cr, Cu, Mn, Ni, V 10 µg/mL: As, Cd, Se, Zn 5 µg/mL: Ag	125 mL	N9303829

REFERENCE MATERIALS

Matrix	Content	Volume	Part No.
5% HNO ₃ /trace Tartaric Acid/trace HF	500 µg/mL: Fe 250 µg/mL: Ba, Zn 100 µg/mL: Co, Cr, Cu, Mn, Ni, Sb, V 50 µg/mL: As, Pb 25 µg/mL: Ag, Be, Cd, Se, Tl	125 mL	N9303839
5% HNO ₃ /trace Tartaric Acid/trace HF	250 µg/mL: Ba, Cr, Cu, Zn 150 µg/mL: V 125 µg/mL: Ni 100 µg/mL: Co, Pb, Sb 50 µg/mL: As, Cd 5 µg/mL: Ag, Be, Se, Tl	125 mL	N9303840
5% HNO ₃	1,000 µg/mL: Al, Ca, Fe, K, Mg, Na 20 µg/mL: Ag, As, Ba, Be, Cd, Co, Cr, Cu, Mn, Ni, Pb, Se, Tl, V, Zn	125 mL	N9303835
H ₂ O/trace HF	7,200 µg/mL: Cl 2,000 µg/mL: C 1,000 µg/mL: P, S 20 µg/mL: Mo, Sb, Ti	125 mL	N9303836
Calibration Standards Set for Method 6010 Includes 1 bottle of each:			N9307104
5% HNO ₃	5,000 µg/mL: Ca, K, Mg, Na	125 mL	N9300218
5% HNO ₃	400 µg/mL: Ni 200 µg/mL: Zn 150 µg/mL: Mn 100 µg/mL: Ag, Cr	125 mL	N9300219
5% HNO ₃	2,000 µg/mL: Al, Ba 1,000 µg/mL: Fe 500 µg/mL: Co, V 250 µg/mL: Cu 50 µg/mL: Be	125 mL	N9300220
5% HNO ₃	100 µg/mL: As, Tl 50 µg/mL: Cd, Pb, Se	125 mL	N9300221
H ₂ O/trace HF	10 µg/mL: B, Ge, Mo, Nb, P, Re, S, Si, Ta, Ti, W, Zr	125 mL	N9300235
2% HNO ₃	1,000 µg/mL: Li	500 mL	N9300129
2% HNO ₃	1,000 µg/mL: Sb	500 mL	N9300101
2% HNO ₃	1,000 µg/mL: Sr	500 mL	N9300153
20% HCl	1,000 µg/mL: Sn	500 mL	N9300161
2% HNO ₃	1,000 µg/mL: Cr	500 mL	N9300112
2% HNO ₃	1,000 µg/mL: Cu	500 mL	N9300114
2% HNO ₃	1,000 µg/mL: Mn	500 mL	N9300132
2% HNO ₃	1,000 µg/mL: Ni	500 mL	N9300136
H ₂ O/tr HF	1,000 µg/mL: Ti	500 mL	N9300162
2% HNO ₃	1,000 µg/mL: V	500 mL	N9300165
2% HNO ₃	1,000 µg/mL: Al	500 mL	N9300100
2% HNO ₃	1,000 µg/mL: Ca	500 mL	N9300108
2% HNO ₃	1,000 µg/mL: Fe	500 mL	N9300126
2% HNO ₃	1,000 µg/mL: Mg	500 mL	N9300131
Internal Standard Set for Method 6010 and 200.7 Includes 1 bottle of each:			N9307105
2% HNO ₃	1,000 µg/mL: Y	500 mL	N9300167
2% HNO ₃	1,000 µg/mL: Sc	500 mL	N9300148

Matrix	Content	Volume	Part No.
Interference Solutions for Method 6010 Includes 1 bottle of each:			N9307106
2% HNO ₃	1,000 µg/mL: Al	125 mL	N9300184
2% HNO ₃	1,000 µg/mL: Ca	500 mL	N9300108
2% HNO ₃	1,000 µg/mL: Mg	125 mL	N9300179
2% HNO ₃	1,000 µg/mL: Fe	500 mL	N9300126
2% HNO ₃	1,000 µg/mL: K	500 mL	N9300141
2% HNO ₃	1,000 µg/mL: Na	500 mL	N9300152
2% HNO ₃	1,000 µg/mL: Cr	500 mL	N9300112
2% HNO ₃	1,000 µg/mL: Cu	500 mL	N9300114
2% HNO ₃	1,000 µg/mL: Mn	500 mL	N9300132
2% HNO ₃	1,000 µg/mL: Ni	500 mL	N9300136
H ₂ O/trace HF	1,000 µg/mL: Ti	500 mL	N9300162
2% HNO ₃	1,000 µg/mL: V	500 mL	N9300165
5% HNO ₃	5,000 µg/mL: Al, Ca, Mg 2,000 µg/mL: Fe	500 mL	N9300226
5% HNO ₃ /trace Tartaric Acid/trace HF	100 µg/mL: Cd, Ni, Zn 60 µg/mL: Sb 50 µg/mL: Ba, Be, Co, Cr, Cu, Mn, V 20 µg/mL: Ag 10 µg/mL: As, Tl 5 µg/mL: Pb, Se	125 mL	N9300227
5% HNO ₃	1,000 µg/mL: Cr, Cu, Mn, Ni, Ti, V	500 mL	N9300228
5% HNO ₃ /trace Tartaric Acid/trace HF	100 µg/mL: Al, As, B, Mo, Na, Sb, Se, Tl 10 µg/mL: Ca, Fe, Mg, Si	125 mL	N9300229
Calibration Standards for Method 200.7 Includes 1 bottle of each:			N9307107
5% HNO ₃	5,000 µg/mL: Ca, K, Mg, Na	125 mL	N9300218
5% HNO ₃	400 µg/mL: Ni 200 µg/mL: Zn 150 µg/mL: Mn 100 µg/mL: Ag, Cr	125 mL	N9300219
5% HNO ₃	2,000 µg/mL: Al, Ba 1,000 µg/mL: Fe 500 µg/mL: Co, V 250 µg/mL: Cu 50 µg/mL: Be	125 mL	N9300220
5% HNO ₃	100 µg/mL: As, Tl 50 µg/mL: Cd, Pb, Se	125 mL	N9300221
H ₂ O/trace HF	10 µg/mL: B, Ge, Mo, Nb, P, Re, S, Si, Ta, Ti, W, Zr	125 mL	N9300235
2% HNO ₃	1,000 µg/mL: Li	500 mL	N9300129
2% HNO ₃	1,000 µg/mL: Sb	500 mL	N9300101
2% HNO ₃	1,000 µg/mL: Sr	500 mL	N9300153
20% HCl	1,000 µg/mL: Sn	500 mL	N9300161
2% HNO ₃	1,000 µg/mL: Cr	500 mL	N9300112
2% HNO ₃	1,000 µg/mL: Cu	500 mL	N9300114
2% HNO ₃	1,000 µg/mL: Mn	500 mL	N9300132
2% HNO ₃	1,000 µg/mL: Ni	500 mL	N9300136
H ₂ O/tr HF	1,000 µg/mL: Ti	500 mL	N9300162
2% HNO ₃	1,000 µg/mL: V	500 mL	N9300165
2% HNO ₃	1,000 µg/mL: Al	500 mL	N9300100
2% HNO ₃	1,000 µg/mL: Ca	500 mL	N9300108
2% HNO ₃	1,000 µg/mL: Fe	500 mL	N9300126
2% HNO ₃	1,000 µg/mL: Mg	500 mL	N9300131
Interference Solutions for Method 200.7 Includes 1 bottle of each:			N9307108
2% HNO ₃	1,000 µg/mL: Al	125 mL	N9300184
2% HNO ₃	1,000 µg/mL: Ca	500 mL	N9300108
2% HNO ₃	1,000 µg/mL: Mg	125 mL	N9300179
2% HNO ₃	1,000 µg/mL: Fe	500 mL	N9300126
2% HNO ₃	1,000 µg/mL: K	500 mL	N9300141
2% HNO ₃	1,000 µg/mL: Na	500 mL	N9300152
5% HNO ₃	5,000 µg/mL: Al, Ca, Mg 2,000 µg/mL: Fe	500 mL	N9300226
5% HNO ₃ /trace Tartaric Acid/trace HF	100 µg/mL: Cd, Ni, Zn 60 µg/mL: Sb 50 µg/mL: Ba, Be, Co, Cr, Cu, Mn, V 20 µg/mL: Ag 10 µg/mL: As, Tl 5 µg/mL: Pb, Se	125 mL	N9300227

Matrix	Content	Volume	Part No.
Environmental EPA Set 1 Includes 1 bottle of each:			N9307110
2% HNO ₃	500 µg/mL: Pb 200 µg/mL: Se 150 µg/mL: Cd, Zn 100 µg/mL: Mn 50 µg/mL: Be	125 mL	N9300200
5% HNO ₃	10,000 µg/mL: Fe 100 µg/mL: Ba, Co, Cu, V	125 mL	N9300201
2% HNO ₃ /trace HF	500 µg/mL: As 100 mg/mL: Mo, Si	125 mL	N9300202
5% HNO ₃	1,000 µg/mL: Ca 400 µg/mL: K 200 µg/mL: Al, Na 20 µg/mL: Cr, Ni	125 mL	N9300203
5% HNO ₃ /trace Tartaric Acid/ trace HF	1,000 µg/mL: Mg 200 µg/mL: Sb, Tl 100 µg/mL: B 50 µg/mL: Ag	125 mL	N9300204
5% HNO ₃	20,000 µg/mL: K 1,000 µg/mL: As, Pb, Tl 500 µg/mL: Se 300 µg/mL: Ag, Ba, Cd, Co, Cr, Cu, Ni, V, Zn 200 µg/mL: Mn 100 µg/mL: Be	125 mL	N9300205
5% HNO ₃	100 µg/mL: Hg	125 mL	N9300223
5% HNO ₃	6,000 µg/mL: Ca 5,000 µg/mL: Fe 3,000 µg/mL: Mgs 1,200 µg/mL: Al 1,000 µg/mL: Na	125 mL	N9300208
H ₂ O/trace HNO ₃ /0.6% Tartaric Acid	1,000 µg/mL: Sb	125 mL	N9300207
5% HNO ₃	ASTM® Type I Water	500 mL	N9307809
5% HCl	ASTM® Type I Water	500 mL	N9307810
Environmental EPA Set 2 Includes 1 bottle of each:			N9307109
2% HNO ₃	500 µg/mL: Pb 200 µg/mL: Se 150 µg/mL: Cd, Zn 100 µg/mL: Mn 50 µg/mL: Be	125 mL	N9300200
5% HNO ₃	10,000 µg/mL: Fe 100 µg/mL: Ba, Co, Cu, V	125 mL	N9300201
2% HNO ₃ /trace HF	500 µg/mL: As 100 µg/mL: Mo, Si	125 mL	N9300202
5% HNO ₃	1,000 µg/mL: Ca 400 µg/mL: K 200 µg/mL: Al, Na 20 µg/mL: Cr, Ni	125 mL	N9300203
5% HNO ₃ /trace Tartaric Acid/ trace HF	1,000 µg/mL: Mg 200 µg/mL: Sb, Tl 100 µg/mL: B 50 µg/mL: Ag	125 mL	N9300204
5% HNO ₃	20,000 µg/mL: K 1,000 µg/mL: As, Pb, Tl 500 µg/mL: Se 300 µg/mL: Ag, Ba, Cd, Co, Cr, Cu, Ni, V, Zn 200 µg/mL: Mn 100 µg/mL: Be	125 mL	N9300205

Matrix	Content	Volume	Part No.
5% HNO ₃	6,000 µg/mL: Ca 5,000 µg/mL: Fe 3,000 µg/mL: Mg 1,200 µg/mL: Al 1,000 µg/mL: Na	125 mL	N9300208
H ₂ O/trace HNO ₃ / 0.6% Tartaric Acid	1,000 µg/mL: Sb	125 mL	N9300207
5% HNO ₃	ASTM® Type I Water	500 mL	N9307809
5% HCl	ASTM® Type I Water	500 mL	N9307810

Water Pollutant Standards

Matrix	Content	Volume	Part No.
Primary Drinking Water Metals			
2% HNO ₃	100 µg/mL: Ba 10 µg/mL: Ag, As, Cr, Hg*, Pb 5 µg/mL: Cd, Se	125 mL	N9300216
Secondary Drinking Water Metals			
2% HNO ₃	500 µg/mL: Zn 100 µg/mL: Cu 30 µg/mL: Fe 5 µg/mL: Mn	125 mL	N9300217
Trace Metals I			
5% HNO ₃	500 µg/mL: Al 250 µg/mL: V 100 µg/mL: As, Be, Co, Cr, Cu, Fe, Mn, Ni, Pb, Zn 25 µg/mL: Cd, Se 10 µg/mL: Hg*	125 mL	N9300211
Trace Metals II			
2% HNO ₃	20 µg/mL: Sb, Tl 10 µg/mL: Ag	125 mL	N9300212
Trace Metals III			
2% HNO ₃	500 µg/mL: Ba, Ca, Mo, Na 100 µg/mL: K, Mg	125 mL	N9300213
Alternate Metals I			
2% HNO ₃	20 µg/mL: Al, Fe, V 10 µg/mL: Co, Cu, Mn, Ni, Zn 5 µg/mL: Be, Sb, Tl	125 mL	N9300214
Alternate Metals II			
2% HNO ₃	500 µg/mL: Ca, Na 100 µg/mL: K, Mg	125 mL	N9300215
2% HNO ₃	500 µg/mL: Ca, Na 100 µg/mL: K, Mg	500 mL	N9303952

Toxicity Characteristic Leachate Procedure (TCLP) Standard

Matrix	Content	Volume	Part No.
TCLP Standard 1			
2% HNO ₃	500 µg/mL: Ba 25 µg/mL: Ag, As, Cr, Pb 100 µg/mL: Hg* 5 µg/mL: Cd, Se	500 mL	N9300241

*Supplied in separate bottle

Instrument Set-Up and Calibration Standards

From instrument installation to instrument calibration, we provide quality set-up, check and calibration standards to ensure instrument performance.

Instrument Calibration Standards

Matrix	Content	Volume	Part No.
Instrument Calibration Standard 1			
5% HNO ₃ /trace Tartaric Acid/trace HF	20 µg/mL: Ag, Al, As, Ba, Be, Cd, Co, Cr, Cu, Mn, Mo, Ni, Pb, Sb, Se, Th, Tl, U, V, Zn	125 mL	N9303816
Instrument Calibration Standard 2			
5% HNO ₃ /trace Tartaric Acid/trace HF	100 µg/mL: Ag, Al, As, Ba, Be, Ca, Cd, Co, Cr, Cu, Fe, K, Mg, Mn, Mo, Na, Ni, Pb, Sb, Se, Sn, Sr, Ti, Tl, V, Zn	125 mL	N9301721
Instrument Calibration Standard 3			
5% HNO ₃	1,000 µg/mL: Ca, Fe, K, Mg, Na	125 mL	N9303818
Initial Calibration Verification Standard 1			
5% HNO ₃ /trace Tartaric Acid	1,000 µg/mL: Ca, Fe, K, Mg, Na, Sr 10 µg/mL: Ag, Al, As, Ba, Be, Cd, Co, Cr, Cu, Mn, Mo, Ni, Pb, Sb, Se, Tl, V, Zn, Th, U	125 mL	N9303825
Initial Calibration Verification Standard 2			
2% HNO ₃ /trace HF	10 µg/mL: Sn, Ti	125 mL	N9303826
ELAN® 6100 DRC Setup/Stab/Masscal Solution			
0.5% HNO ₃	10 µg/L: Ba 1 µg/L: Al, Cd, Ce, Cr, Cu, In, Pb, Mg, Mn, Rh, Th	1,000 mL	N8125035
ELAN DRC/DRCplus/DRC II Solution Kit			
Kit Includes:			N8120541
	2 x 1,000 mL: Setup/Stability/Masscal Solution		N8125035
	2 x 250 mL: Wash Solution		N8125033
	1 x 250 mL: Sensitivity/Detection Limit Solution		N8125034
	1 x 125 mL: Methanol Blank Solution		N8125037
	1 x 125 mL: Chromium in Methanol Solution		N8125038
ELAN 9000/6100 Solution Kit			
Kit Includes:			N8120522
	2 x 1,000 mL: Setup/Stability/Masscal Solution		N8125030
	1 x 125 mL: Dual-Detector		N8125010
	1 x 1,000 mL: Wash Solution		N8122038
	1 x 250 mL: Detection Limit Solution		N8125031
ELAN 9000/6100 Setup/Stability/Masscal Solution			
1% HNO ₃	10 µg/L: Ba, Cd, Ce, Cu, In, Pb, Mg, Rh, U	1,000 mL	N8125030
ELAN 9000/6x00 Dual-Detector Calibration Solution			
1% HNO ₃	200 µg/L: Cd, Cu, Pb, Mg, Rh	125 mL	N8125032
ELAN 6000/5000 Plasma Setup Solution			
2% HNO ₃	10 µg/L: Ba, Cd, Ce, Cu, Ge, Pb, Mg, Rh, Sc, Tb, Tl	1,000 mL	N8122014
ELAN 5000 Detection Limit Solution			
2% HNO ₃	10 µg/L: Be, Co, Ge, In, Tl, U	125 mL	N8122017

SmartTune Standards

Matrix	Content	Volume	Part No.
SmartTune Solution for Standard ELANS/DRC-e			
1% HNO ₃	10 µg/L: Ba, Be, Ce, Co, In, Pb, Mg, Rh, U	1,000 mL	N8125040
SmartTune Solution for DRC/DRCplus/DRC II			
0.5% HNO ₃	10 µg/L: Ba 1 µg/L: Be, Ce, Co, In, Fe, Pb, Mg, Th, U	1,000 mL	N8125041
Tuning Solution 1			
2% HNO ₃ /	10 µg/mL: Ba, Be, Ce, Co, In, Li,	125 mL	N9303843
5% HCl	Mg, Pb, Rh, Tl, U, Y		
NexION Setup Solution			
1% HNO ₃	1 µg/L: Be, Ce, Fe, In, Li, Mg, Pb, U	500 mL	N8145051
1% HNO ₃	10 µg/L: Be, Ce, Fe, In, Li, Mg, Pb, U	500 mL	N8145284

ICP-OES Solutions

Matrix	Volume	Part No.
UV Wavecal Solution	500 mL	N0582152
Mixed Calibration Standard	500 mL	N0691579
Low UV Standard	250 mL	N0691580
Calcium Stray Light Standard	125 mL	N0691581
VIS Align Solution	100 mL	N0691743
Magnesium Standard Pure	125 mL	N0691745
Optima Blank in 2% HNO ₃	500 mL	N0773120
Instrument Calibration Standard 4	125 mL	N9300221
Vis Wavecal Solution	250 mL	N9302946

Instrument Setup Solutions

Matrix	Content	Volume	Part No.
Vis Wavecal Solution			
2% HNO ₃	50 µg/mL: K 10 µg/mL: La, Li, Mn, Na, Sr 1 µg/mL: Ba, Ca	250 mL	N9302946
UV Wavecal Solution			
5% HCl	100 µg/mL: K, P, S 20 µg/mL: As, La, Li, Mn, Mo, Na, Mo, Na, Ni, Sc	250 mL	N0681470
5% HCl	100 µg/mL: K, P, S 20 µg/mL: As, La, Li, Mn, Mo, Na, Ni, Sc 1 µg/mL: Ca	500 mL	N0582152
Low UV Standard			
2% HNO ₃	10 µg/mL: Al, P, S	250 mL	N0691580
Calcium Stray Light Standard			
H ₂ O	10,000 µg/mL: Ca	125 mL	N0691581
1% HNO ₃	10 µg/L: Be, Ce, Fe, In, Li, Mg, Pb, U	500 mL	N8145284

Initial Calibration Verification Standards

Matrix	Contents	Volume	Part No.
5% HNO ₃ /trace Tartaric Acid	500 µg/mL: Ca, K, Mg, Na 200 µg/mL: Al, Ba 100 µg/mL: Fe 60 µg/mL: Sb 50 µg/mL: Co, V 40 µg/mL: Ni 25 µg/mL: Cu 20 µg/mL: Zn 15 µg/mL: Mn 10 µg/mL: Ag, As, Cr, Tl 5 µg/mL: Be, Cd, Se 3 µg/mL: Pb	500 mL	N9300224
5% HNO ₃ /trace Tartaric Acid	500 µg/mL: Ca, K, Mg, Na 200 µg/mL: Al, Ba 100 µg/mL: Fe 60 µg/mL: Sb 50 µg/mL: Co, V 40 µg/mL: Ni 25 µg/mL: Cu 20 µg/mL: Zn 15 µg/mL: Mn 10 µg/mL: Ag, As, Cr, Tl 5 µg/mL: Be, Cd, Se 3 µg/mL: Pb	125 mL	N9303953

Instrument Calibration Standards for CLP

Matrix	Content	Volume	Part No.
Instrument Calibration Standard 1			
5% HNO ₃	5,000 µg/mL: Ca, K, Mg, Na	125 mL	N9300218
Instrument Calibration Standard 2			
5% HNO ₃	400 µg/mL: Ni 200 µg/mL: Zn 150 µg/mL: Mn 100 µg/mL: Ag, Cr	125 mL	N9300219
Instrument Calibration Standard 3			
5% HNO ₃	2,000 µg/mL: Al, Ba 1,000 µg/mL: Fe 500 µg/mL: Co, V 250 µg/mL: Cu 50 µg/mL: Be	125 mL	N9300220
Instrument Calibration Standard 4			
5% HNO ₃	100 µg/mL: As, Tl 50 µg/mL: Cd, Se 30 µg/mL: Pb	125 mL	N9300221

Instrument Calibration Standards for CLP

Matrix	Content	Volume	Part No.
Instrument Check Standard 1			
2% HNO ₃ /trace Tartaric Acid/trace HF	10 µg/mL: Ag, Al, As, Ba, Be, Cd, Co, Cr, Cu, Mn, Ni, Pb, Sb, Se, Tl, V, Zn	125 mL	N9303821
Instrument Check Standard 3			
2% HNO ₃	200 µg/mL: Ca, Fe, K, Mg, Na	125 mL	N9303822
Instrument Check Standard 4			
2% HNO ₃	10 µg/mL: Mo, Th, U	125 mL	N9303823
Instrument Check Standard 5			
2% HNO ₃ /trace HF	10 µg/mL: Mo, Sn, Sr, Ti	125 mL	N9303824

Interference Check Standards

Matrix	Content	Volume	Part No.
Interference Check Standard 1			
H ₂ O/trace HNO ₃ /0.6% Tartaric Acid	1,000 µg/mL: Sb	125 mL	N9300207
Interference Check Standard 5			
5% HNO ₃	6,000 µg/mL: Ca 5,000 µg/mL: Fe 3,000 µg/mL: Mg 1,200 µg/mL: Al 1,000 µg/mL: Na	125 mL	N9300208
Interference Check Standard 18			
5% HNO ₃	20,000 µg/mL: K 1,000 µg/mL: As, Pb, Tl 500 µg/mL: Se 300 µg/mL: Ag, Ba, Cd, Co, Cr, Cu, Ni, V, Zn 200 µg/mL: Mn 100 µg/mL: Be, Hg*	125 mL	N9300205
Interferents A			
5% HNO ₃	5,000 µg/mL: Al, Ca, Mg 2,000 µg/mL: Fe	500 mL	N9300226
Alternate Interferents A			
5% HNO ₃	1,000 µg/mL: Cr, Cu, Mn, Ni, Ti, V	500 mL	N9300228
Analytes B			
5% HNO ₃ /trace Tartaric Acid/trace HF	100 µg/mL: Cd, Ni, Zn 60 µg/mL: Sb 50 µg/mL: Ba, Be, Co, Cr, Cu, Mn, V 20 µg/mL: Ag 10 µg/mL: As, Tl 5 µg/mL: Pb, Se	125 mL	N9300227
Alternate Analytes B			
5% HNO ₃ /trace Tartaric Acid/trace HF	100 µg/mL: Al, As, B, Mo, Na, Sb, Se, Tl 10 µg/mL: Ca, Fe, Mg, Si	125 mL	N9300229
Interference Check Standards			
H ₂ O/trace HNO ₃ /0.6% Tartaric Acid	1,000 µg/mL: Sb	500 mL	N9303797
Interference Check Solution 1 (for SW-846 and ILM 05.2)			
5% HNO ₃ /trace HF	10,000 µg/mL: Cl 2,000 µg/mL: C 1,000 µg/mL: Al, Ca, Fe, K, Mg, Na, P, S 20 µg/mL: Mo, Ti	125 mL	N9303828
Interference Check Solution 2 (for SW-846)			
2% HNO ₃	10 µg/mL: Ag, As, Cd, Co, Cr, Cu, Mn, Ni, Zn	125 mL	N9303830
Analytes C (for ILM 05.2)			
2% HNO ₃ /trace Tartaric Acid/trace HF	2 µg/mL: Ag, As, Ba, Be, Cd, Co, Cr, Cu, Hg*, Mn, Ni, Pb, Sb, Se, Tl, V, Zn	125 mL	N9303831

*Supplied in separate bottle

Internal Standard Solutions

Matrix	Content	Volume	Part No.
Multi-Element Internal Standard			
2% HNO ₃	10 µg/mL: Bi, Ho, In, Li6, Sc, Tb, Y	125 mL	N9303834
Multi-Element Internal Standard			
2% HNO ₃	10 µg/mL: Bi, Ho, In, Li6, Sc, Tb, Y	100 mL	N9301722
Internal Standard Mix			
5-10% HNO ₃	10 µg/mL: Bi, Ge, In, Li6, Sc, Tb, Y	125 mL	N9303832
Internal Standard Mix			
5-10% HNO ₃	10 µg/mL: Bi, Ge, In, Li6, Sc, Tb, Y	500 mL	N9303833

Contract Required Detection Limits (CRDL)

Matrix	Content	Volume	Part No.
% HNO ₃ / trace Tartaric Acid/ trace HF	120 µg/mL: Sb 100 µg/mL: Co, V 80 µg/mL: Ni 50 µg/mL: Cu 40 µg/mL: Zn 30 µg/mL: Mn 20 µg/mL: Ag, As, Cr, Tl 10 µg/mL: Be, Cd, Se 6 µg/mL: Pb	125 mL	N9300225

Performance Verification Standards

Matrix	Content	Volume	Part No.
Methanol Blank Solution			
1% Semiconductor Grade		125 mL	N8125037
Chromium in Methanol Solution			
1% Semiconductor Grade Methanol	10 µg/mL: Cr	125 mL	N8125038
Selenium Solution			
5% HNO ₃	10 µg/mL: Se	250 mL	N8125039
NexION 350Q Solution Kit – Non-Cell			
Kit Includes:			N8140503
1% HNO ₃	1 x 250 mL NexION Wash Solution		N8145050
	1 x 500 mL NexION Setup Solution		N8145051
	1 x 500 mL NexION 300Q Non-cell Stability Solution		N8145053
	1 x 100 mL NexION Standard/ DRC Mode Detection Limit Blank Solution		N8145055
	1 x 100 mL NexION Standard/ DRC Mode Detection Limit Solution		N8145056
	1 x 100 mL NexION Dual Detector Solution		N8145059
NexION 350 X/D/S 1000/2000 Solution Kit – Cell Instruments			
Kit Includes:			N8140504
	1 x 250 mL NexION Wash Solution		N8145050
	1 x 500 mL NexION Setup Solution		N8145051
	1 x 250 mL NexION KED Setup Solution		N8145052
	1 x 500 mL NexION 350X/D/S Cell Stability Solution		N8145054
	1 x 100 mL NexION Standard/DRC Mode Detection Limit Blank Solution		N8145055
	1 x 100 mL NexION Standard/DRC Mode Detection Limit Solution		N8145056
	1 x 100 mL NexION KED Mode Detection Limit Blank Solution		N8145057
	1 x 100 mL NexION KED Mode Detection Limit Solution		N8145058
	1 x 100 mL NexION Dual Detector Solution		N8145059

Performance Verification Standards continued

Matrix	Content	Volume	Part No.
NexION Setup Solution			
1% HNO ₃	1 µg/L: Be, Ce, Fe, In, Li, Mg, Pb, U	500 mL	N8145051
1% HNO ₃	10 µg/L: Be, Ce, Fe, In, Li, Mg, Pb, U	500 mL	N8145284
NexION KED Setup Solution			
1% HNO ₃	10 µg/mL: Be, Ce, Fe, In, Li, Mg, Pb, U	500 mL	N8145289
1% HCl	10 µg/L: Co 1 µg/L: Ce	250 mL	N8145052
NexION Fit Spec. Verify Solution			
1% HNO ₃	1 mg/L ± 5 % Li, Be, Mg, Fe, In, Ce, Pb, U	125 mL	N8145049
Internal Stock Solution			
5% HNO ₃	12.5 µg/mL Ni, Sc, Te, Y	100 mL	N8145419
Internal Stock Solution			
5% HNO ₃	12.5 µg/mL Ni, Sc, Te, Y	500 mL	N8145420
Special 1 Pure Plus			
2% HNO ₃	200 µg/mL Ca, K, Na, P 40 µg/mL Mg 4 µg/mL Fe, Zn 200 µg/L Cu 100 µg/L Mn 40 µg/L Cr, Mo, Se	100 mL	N8145421
Special 2 Pure Plus			
5% HNO ₃	1000 µg/mL Ca, K, Na, P 200 µg/mL Mg 20 µg/mL Fe, Zn 1000 µg/L Cr, Mo, Se	100 mL	N8145422
NexION 350Q/2000 Non-cell Stability Solution			
1% HNO ₃	1 µg/L: Cd, Cu, Mg, Pb	500 mL	N8145053
NexION 350X/D/S/1000/2000 Cell Stability Solution			
1% HNO ₃	1 µg/L: Cd, Cr, Fe, Mg, Pb 10 µg/L: Co, Cu, In, Se	500 mL	N8145054
NexION 1000/2000 Cell Stability Solution without Se			
1% HNO ₃	1 µg/L: Cd, Cr, Fe, In, Mg, Pb 10 µg/L: Co, Cu	500 mL	N8151033
NexION 350X/D Internal Standard Stock Solution			
2% HNO ₃	100 µg/mL: Sc 50 µg/mL: Ge 1 µg/mL: Rh, In, Tb	125 mL	N9308592
NexION 350Q Internal Standard Stock Solution			
2% HNO ₃	50 µg/mL: Sc, Ge 10 µg/mL: Rh, In, Tb	125 mL	N9308591
NexION Standard/DRC Mode Detection Limit Blank Solution			
0.5% HNO ₃		100 mL	N8145055
NexION Standard/DRC Mode Detection Limit Solution			
0.5% HNO ₃	1 µg/L: Be, Ca, Co, Fe, In, U	100 mL	N8145056
NexION KED Mode Detection Limit Blank Solution			
1% HCl		100 mL	N8145057
NexION KED Mode Detection Limit Solution			
1% HCl	10 µg/L: V, As, Se	100 mL	N8145058
NexION Dual Detector Solution			
2% HNO ₃	200 µg/L: Al, Ba, Ce, Co, Cu, In, Li, Mg, Mn, Ni, Pb, Tb, U, Zn	100 mL	N8145059

Performance Verification Standards continued

Matrix	Content	Volume	Part No.
NexION AFT Single-Element Solution			
2% HNO ₃	2 µg/L: Fe	100 mL	N8145060
NexION AFT Multi-Element Solution			
2% HNO ₃	2 µg/L: Ag, Al, As, Ba, Be, Bi, Be, Bi, Ca, Cd, Co, Cr, Cs, Cu, Fe, Ga, In, K, Li, Mg, Mn, Na, Ni, Pb, Rb, Se, Sr, Tl, U, V, Zn	100 mL	N8145061
NexION AFT Single-Element Solution (H/He)			
2% HNO ₃	10 µg/L Se	125 mL	N8151037
NexION AFT Multi-Element Solution (H/He)			
2% HNO ₃	10 µg/L Ag, Al, AS, Ba, Be, Bi, Ca, Cd, Co, Cr, Cs, Cu, Fe, Ga, In, K, Li, Mg, Mn, Na, Ni, Pb, Rb, Se, Sr, Tl, U, V, Zn	125 mL	N8151038
Cold Plasma Optimization Solution			
0.1% HNO ₃	1 µg/L Li, Co, Rb, In, Cs, Pb	250 mL	N8151032

Wash Standards and Matrix Blanks

Wash Standards

Matrix	Volume	Part No.
ELAN DRC Wash Solution		
0.5% HNO ₃	250 mL	N8125033
ELAN 9000/6X00/DRC-e Wash Solution		
1% HNO ₃	1,000 mL	N8122038
NexION Wash Solution		
1% HNO ₃	250 mL	N8145050

Matrix Blanks

Matrix	Volume	Part No.
Water Blank		
		N8125033
ASTM® Type I Water, 18 megohm	125 mL	N9303814
ASTM® Type I Water, 18 megohm	250 mL	N9303813
Hydrochloric Acid Blanks		
2% HCl in ASTM® Type I Water	125 mL	N9300238
5% HNO ₃ in ASTM® Type I Water	500 mL	N9308571
Nitric Acid Blanks		
1% HNO ₃ in ASTM® Type I Water	125 mL	N9303732
2% HNO ₃ in ASTM® Type I Water	500 mL	N0773120
2% HNO ₃ in ASTM® Type I Water	500 mL	N9308550
5% HNO ₃ in ASTM® Type I Water	500 mL	N9308571

Isotope Standard

Matrix	Content	Volume	Part No.
Lithium 6 Standard			
2% HNO ₃	100 mg/L: Li6	125 mL	N9303955



Universal Data Calibration Standards Kit

Matrix	Content	Volume	Part No.
Solution Kit			N9306225
Includes 1 bottle of each:			
5% HNO ₃	10 µg/mL: Ce, Dy, Er, Eu, Gd, Ho, La, Lu, Nd, Pr, Sm, Sc, Tb, Th, Tm, Y, Yb	125 mL	N9303816
5% HNO ₃	10 µg/mL: Al, Ag, As, Ba, Be, Bi, Ca, Cd, Co, Cr, Cs, Cu, Fe, Ga, Hg*, In, K, Li, Mg, Mn, Na, Ni, Pb, Rb, Se, Sr, Tl, U, V, Zn	125 mL	
10% HCl/ 1% HNO ₃	10 µg/mL: Au, Hf, Ir, Pd, Pt, Rh, Ru, Sb, Sn, Te	125 mL	
5% HNO ₃	10 µg/mL: Hg*	125 mL	
H ₂ O /trace HF/ trace HNO ₃	10 µg/mL: B, Ge, Mo, Nb, P, Re, S, Si, Ta, Ti, W, Zr	125 mL	

*Supplied in separate bottle

Pharmaceutical Analysis Standards

USP Standards

As a part of our United States Pharmacopeia (USP) compliant offering, we provide calibration and check standards for the analysis of metals in drugs, pharmaceutical substances and raw materials to verify Oral Daily Dose PDE, Parenteral Component Limit and Parenteral Daily Dose PDE.

Our trace metal USP standards can be used to calibrate Arsenic, Cadmium, Lead and Mercury, the four toxic metals as part of the USP regulations. When you couple our accurate and reliable USP standards with your ICP-MS you will remain compliant with the new and changing regulations.

ICH Standards

In conjunction with our United States Pharmacopeia (USP) calibration standards, we offer six calibration standards for the analysis of metals in pharmaceutical materials and products following the International Conference on Harmonization (ICH) guidelines.

The ICH standards verify Elemental Impurities, Precious Metals Impurities and Parenteral Elemental Impurities. Couple our accurate and reliable ICH standards with your ICP-MS and you will remain compliant with the new and changing regulations.

USP and ICH Standards

Matrix	Content	Volume	Part No.
ICH Elemental Impurities Standards Kit – Oral PDEs Kit Includes:			
5% HNO ₃ / 2% HCl	ICH Class 1 Elements + TI – Oral PDE: 30 µg/mL Hg 15 µg/mL As 8 µg/mL TI 5 µg/mL Cd, Pb	125 mL	N9304362
2% HNO ₃	ICH Class 2A Elements – Oral and Parenteral PDEs: 200 µg/mL Ni 100 µg/mL V 50 µg/mL Co	125 mL	N9304363
2% HCl	100 µg/mL Au	125 mL	N9303728
15% HCl	ICH Class 2B Precious Metal Elements (no Os) – All PDEs: 100 µg/mL Ir, Pd, Pt, Rh, Ru	125 mL	N9304364
2% HNO ₃	ICH Class 2B Se and Ag – Oral PDE: 150 µg/mL Ag, Se	125 mL	N9304365
5% HNO ₃ /trace Tartaric Acid/ trace HF	ICH Class 3 Elements – Oral PDEs: 1100 µg/mL Cr 600 µg/mL Sn 300 µg/mL Cu, Mo 140 µg/mL Ba 120 µg/mL Sb 55 µg/mL Li	125 mL	N9304366
2% HNO ₃	Internal Standards – All PDEs: 50 µg/mL Ge 20 µg/mL Ga 1 µg/mL In, Tb	125 mL	N9304367

Matrix	Content	Volume	Part No.
ICH Elemental Impurities Standards Kit – Parenteral PDEs Kit Includes:			
5% HNO ₃ / 2% HCl	ICH Class 1 Elements + TI – Parenteral PDE: 15 µg/mL As 8 µg/mL TI 5 µg/mL Pb 3 µg/mL Hg 2 µg/mL Cd	125 mL	N9304369
2% HNO ₃	ICH Class 2A Elements – Oral and Parenteral PDEs: 200 µg/mL Ni 100 µg/mL V 50 µg/mL Co	125 mL	N9304363
2% HCl	100 µg/mL Au	125 mL	N9303728
15% HCl	ICH Class 2B Precious Metal Elements (no Os) – All PDEs: 100 µg/mL Ir, Pd, Pt, Rh, Ru	125 mL	N9304364
2% HNO ₃	ICH Class 2B Se and Ag – Parenteral PDE: 80 µg/mL Se 10 µg/mL Ag	125 mL	N9304372
2% HNO ₃ /trace Tartaric Acid/ trace HF	ICH Class 3 Elements – Parenteral PDEs: 150 µg/mL Mo 110 µg/mL Cr 60 µg/mL Sn 30 µg/mL Cu 70 µg/mL Ba 25 µg/mL Li 9 µg/mL Sb	125 mL	N9304373
2% HNO ₃	Internal Standards – All PDEs: 50 µg/mL Ge 20 µg/mL Ga 1 µg/mL In, Tb	125 mL	N9304367



USP and ICH Standards continued

Matrix	Content	Volume	Part No.
ICH Elemental Impurities Standards Kit – Inhalational PDEs Kit Includes:			
5% HNO ₃ / 2% HCl	ICH Class 1 Elements + TI – Inhalational PDEs: 8 µg/mL TI 5 µg/mL Pb 2 µg/mL As, Cd 1 µg/mL Hg	125 mL	N9304376
2% HNO ₃	ICH Class 2A Elements – Inhalational PDEs: 5 µg/mL Ni 3 µg/mL Co 1 µg/mL V	125 mL	N9304377
2% HCl	100 µg/mL Au	125 mL	N9303728
15% HCl	ICH Class 2B Precious Metal Elements (no Os) – All PDEs: 100 µg/mL Ir, Pd, Pt, Rh, Ru	125 mL	N9304364
2% HNO ₃	ICH Class 2B Se and Ag – Inhalational PDE: 130 µg/mL Se 7 µg/mL Ag	125 mL	N9304379
2% HNO ₃ /trace Tartaric Acid/ trace HF	ICH Class 3 Elements – Inhalational PDEs: 300 µg/mL Ba 60 µg/mL Sn 30 µg/mL Cu 25 µg/mL Li 20 µg/mL Sb 10 µg/mL Mo 3 µg/mL Cr	125 mL	N9304380
2% HNO ₃	Internal Standards – All PDEs: 50 µg/mL Ge 20 µg/mL Ga 1 µg/mL In, Tb	125 mL	N9304367

Matrix	Content	Volume	Part No.
ICH Class 2B Precious Metal Elements – All PDEs			
15% HCl	ICH Class 2B Precious Metal Elements – All PDEs: 100 µg/mL Ir, Os, Pd, Pt, Rh, Ru	125 mL	N9304382

Matrix	Content	Volume	Part No.
Osmium			
15% HCl	100 µg/mL Os	125 mL	N9304383

Gold Nanoparticle Standards

Fully characterized gold nanospheres designed for Single Particle-ICP-MS. These particle standards have a nearly perfect spherical shape, narrow size (CV < 5%) and particle number distributions (CV < 5%).

Description	Diameter (nm)	Volume	Part No.
Ultra Uniform Gold Nanospheres Particle Standard 1e7 particles/mL, PEG Carboxyl 0.8 kDa	30	25 mL	N8151034
Ultra Uniform Gold Nanospheres Particle Standard 1e7 particles/mL, PEG Carboxyl 0.8 kDa	50	25 mL	N8151035
Ultra Uniform Gold Nanospheres Particle Standard 1e7 particles/mL, PEG Carboxyl 0.8 kDa	100	25 mL	N8151036

Metallo-Organic Standards

PerkinElmer Metallo-Organic Standards provide a comprehensive solution to your application needs.

Our product offering includes:

- Single and multi-element standards for the analysis of wear metals and metal additives in oil
- Reference materials for used oil analysis of fuel, soot, water, acid number, base number or viscosity
- Sulfur standards made from polysulfide oil
- High purity matrix oils and solvents
- Proficiency testing standards with instant feedback

Each product is shipped with a comprehensive Certificate of Analysis. Our Metallo-Organic Standards have been designed to give you the confidence you need when analyzing difficult samples.



Single-Element, Metallo-Organic Standards

Element	Symbol	Matrix	Size	Part No.
Aluminum 1000 µg/g	Al	Hydrocarbon Oil	50 g	N9308200
Aluminum 5000 µg/g	Al	Hydrocarbon Oil	50 g	N9308729
Antimony 1000 µg/g	Sb	Hydrocarbon Oil	50 g	N9308201
Arsenic 1000 µg/g	As	Hydrocarbon Oil	50 g	N9308202
Barium 1000 µg/g	Ba	Hydrocarbon Oil	50 g	N9308203
Beryllium 1000 µg/g	Be	Hydrocarbon Oil	50 g	N9308204
Bismuth 1000 µg/g	Bi	Hydrocarbon Oil	50 g	N9308205
Boron 1000 µg/g	B	Hydrocarbon Oil	50 g	N9308206
Cadmium 1000 µg/g	Cd	Hydrocarbon Oil	50 g	N9308207
Calcium 1000 µg/g	Ca	Hydrocarbon Oil	50 g	N9308208
Calcium 5000 µg/g	Ca	Hydrocarbon Oil	50 g	N9308322
Chromium 1000 µg/g	Cr	Hydrocarbon Oil	50 g	N9308209
Cobalt 1000 µg/g	Co	Hydrocarbon Oil	50 g	N9308210
Copper 1000 µg/g	Cu	Hydrocarbon Oil	50 g	N9308211
Iron 1000 µg/g	Fe	Hydrocarbon Oil	50 g	N9308212
Lanthanum 1000 µg/g	La	Hydrocarbon Oil	50 g	N9308213
Lead 1000 µg/g	Pb	Hydrocarbon Oil	50 g	N9308214
Lithium 1000 µg/g	Li	Hydrocarbon Oil	50 g	N9308215
Magnesium 1000 µg/g	Mg	Hydrocarbon Oil	50 g	N9308216
Manganese 1000 µg/g	Mn	Hydrocarbon Oil	50 g	N9308217
Mercury 1000 µg/g	Hg	Hydrocarbon Oil	50 g	N9308218
Molybdenum 1000 µg/g	Mo	Hydrocarbon Oil	50 g	N9308219

Element	Symbol	Matrix	Size	Part No.
Nickel 1000 µg/g	Ni	Hydrocarbon Oil	50 g	N9308220
Phosphorus 1000 µg/g	P	Hydrocarbon Oil	50 g	N9308221
Potassium 1000 µg/g	K	Hydrocarbon Oil	50 g	N9308222
Scandium 1000 µg/g	Sc	Hydrocarbon Oil	50 g	N9308223
Selenium 1000 µg/g	Se	Hydrocarbon Oil	50 g	N9308224
Silicon 1000 µg/g	Si	Hydrocarbon Oil	50 g	N9308225
Silver 1000 µg/g	Ag	Hydrocarbon Oil	50 g	N9308226
Sodium 1000 µg/g	Na	Hydrocarbon Oil	50 g	N9308227
Strontium 1000 µg/g	Sr	Hydrocarbon Oil	50 g	N9308228
Sulfur 10 µg/g	S	Hydrocarbon Oil	50 g	N9308229
Sulfur 100 µg/g	S	Hydrocarbon Oil	50 g	N9308230
Sulfur 1000 µg/g	S	Hydrocarbon Oil	50 g	N9308231
Thallium 1000 µg/g	Tl	Hydrocarbon Oil	50 g	N9308232
Tin 1000 µg/g	Sn	Hydrocarbon Oil	50 g	N9308233
Titanium 1000 µg/g	Ti	Hydrocarbon Oil	50 g	N9308234
Vanadium 1000 µg/g	V	Hydrocarbon Oil	50 g	N9308235
Yttrium 1000 µg/g	Y	Hydrocarbon Oil	50 g	N9308236
Yttrium 5000 µg/g	Y	Hydrocarbon Oil	50 g	N9308323
Zinc 1000 µg/g	Zn	Hydrocarbon Oil	50 g	N9308237
Zirconium 1000 µg/g	Zr	Hydrocarbon Oil	50 g	N9308238

Lubricant Guide

For more information on our Lubricants consumables offering visit www.PerkinElmer.com/lubricants. You'll find everything from application notes to a comprehensive guide of consumables for all your Lubricants analysis needs.



V-21 Wear Metal Standards

Includes: Ag, Al, B, Ba, Ca, Cd, Cr, Cu, Fe, Mg, Mn, Mo, Na, Ni, P, Pb, Si, Sn, Ti, V, Zn

Description	Matrix	Size	Part No.
V-21 Wear Metals Standard 10 µg/g	Hydrocarbon Oil	100 g	N9308300
V-21 Wear Metals Standard 10 µg/g	Hydrocarbon Oil	200 g	N9308301
V-21 Wear Metals Standard 10 µg/g	Hydrocarbon Oil	400 g	N9308324
V-21 Wear Metals Standard 30 µg/g	Hydrocarbon Oil	100 g	N9308302
V-21 Wear Metals Standard 30 µg/g	Hydrocarbon Oil	200 g	N9308303
V-21 Wear Metals Standard 30 µg/g	Hydrocarbon Oil	400 g	N9308325
V-21 Wear Metals Standard 50 µg/g	Hydrocarbon Oil	100 g	N9308304
V-21 Wear Metals Standard 50 µg/g	Hydrocarbon Oil	200 g	N9308305
V-21 Wear Metals Standard 50 µg/g	Hydrocarbon Oil	400 g	N9308326
V-21 Wear Metals Standard 100 µg/g	Hydrocarbon Oil	100 g	N9308306
V-21 Wear Metals Standard 100 µg/g	Hydrocarbon Oil	200 g	N9308307
V-21 Wear Metals Standard 100 µg/g	Hydrocarbon Oil	400 g	N9308327
V-21 Wear Metals Standard 300 µg/g	Hydrocarbon Oil	100 g	N9308308
V-21 Wear Metals Standard 300 µg/g	Hydrocarbon Oil	200 g	N9308309
V-21 Wear Metals Standard 300 µg/g	Hydrocarbon Oil	400 g	N9308328
V-21 Wear Metals Standard 500 µg/g	Hydrocarbon Oil	100 g	N9308310
V-21 Wear Metals Standard 500 µg/g	Hydrocarbon Oil	200 g	N9308311
V-21 Wear Metals Standard 500 µg/g	Hydrocarbon Oil	400 g	N9308329
V-21 Wear Metals Standard 900 µg/g	Hydrocarbon Oil	100 g	N9308312
V-21 Wear Metals Standard 900 µg/g	Hydrocarbon Oil	200 g	N9308313
V-21 Wear Metals Standard 900 µg/g	Hydrocarbon Oil	400 g	N9308330

V-21+K Wear Metal Standards

Includes: Ag, Al, B, Ba, Ca, Cd, Cr, Cu, Fe, K, Mg, Mn, Mo, Na, Ni, P, Pb, Si, Sn, Ti, V, Zn

Description	Matrix	Size	Part No.
V-21+K Wear Metals Standard 10 µg/g	Hydrocarbon Oil	100 g	N9308355
V-21+K Wear Metals Standard 10 µg/g	Hydrocarbon Oil	200 g	N9308356
V-21+K Wear Metals Standard 30 µg/g	Hydrocarbon Oil	100 g	N9308357
V-21+K Wear Metals Standard 30 µg/g	Hydrocarbon Oil	200 g	N9308358
V-21+K Wear Metals Standard 30 µg/g	Hydrocarbon Oil	400 g	N9308371
V-21+K Wear Metals Standard 50 µg/g	Hydrocarbon Oil	100 g	N9308359
V-21+K Wear Metals Standard 50 µg/g	Hydrocarbon Oil	200 g	N9308360
V-21+K Wear Metals Standard 50 µg/g	Hydrocarbon Oil	400 g	N9308372
V-21+K Wear Metals Standard 100 µg/g	Hydrocarbon Oil	100 g	N9308361
V-21+K Wear Metals Standard 100 µg/g	Hydrocarbon Oil	200 g	N9308362
V-21+K Wear Metals Standard 100 µg/g	Hydrocarbon Oil	400 g	N9308373
V-21+K Wear Metals Standard 300 µg/g	Hydrocarbon Oil	100 g	N9308363
V-21+K Wear Metals Standard 300 µg/g	Hydrocarbon Oil	200 g	N9308364
V-21+K Wear Metals Standard 500 µg/g	Hydrocarbon Oil	100 g	N9308365
V-21+K Wear Metals Standard 500 µg/g	Hydrocarbon Oil	200 g	N9308366
V-21+K Wear Metals Standard 500 µg/g	Hydrocarbon Oil	400 g	N9308374
V-21+K Wear Metals Standard 900 µg/g	Hydrocarbon Oil	100 g	N9308367
V-21+K Wear Metals Standard 900 µg/g	Hydrocarbon Oil	200 g	N9308368

Internal Standards

Description	Matrix	Size	Part No.
Cobalt (Co) Internal Standard, 6%	Mineral Spirits	200 g	N0776107
Cobalt (Co) Internal Standard, 6%	Mineral Spirits	400 g	N9308334
Cobalt (Co) Internal Standard, 5000 µg/g	Hydrocarbon Oil	50 g	N9308258
Cobalt Sulfur-Free Metallo-Organic Concentrate: Co @ approx 3%	Hydrocarbon Oil	400 g	N9304168

V-23 Wear Metal Standards

Includes: Ag, Al, B, Ba, Ca, Cd, Cr, Cu, Fe, K, Mg, Mn, Mo, Na, Ni, P, Pb, Sb, Si, Sn, Ti, V, Zn

Description	Matrix	Size	Part No.
V-23 Wear Metals Standard 10 µg/g	Hydrocarbon Oil	100 g	N9308239
V-23 Wear Metals Standard 10 µg/g	Hydrocarbon Oil	200 g	N0776109
V-23 Wear Metals Standard 10 µg/g	Hydrocarbon Oil	400 g	N9308315
V-23 Wear Metals Standard 30 µg/g	Hydrocarbon Oil	100 g	N9308241
V-23 Wear Metals Standard 30 µg/g	Hydrocarbon Oil	200 g	N9308242
V-23 Wear Metals Standard 30 µg/g	Hydrocarbon Oil	400 g	N9308316
V-23 Wear Metals Standard 50 µg/g	Hydrocarbon Oil	100 g	N9308243
V-23 Wear Metals Standard 50 µg/g	Hydrocarbon Oil	200 g	N0776104
V-23 Wear Metals Standard 50 µg/g	Hydrocarbon Oil	400 g	N9308317
V-23 Wear Metals Standard 100 µg/g	Hydrocarbon Oil	100 g	N9308245
V-23 Wear Metals Standard 100 µg/g	Hydrocarbon Oil	200 g	N0776105
V-23 Wear Metals Standard 100 µg/g	Hydrocarbon Oil	400 g	N9308318
V-23 Wear Metals Standard 300 µg/g	Hydrocarbon Oil	100 g	N9308247
V-23 Wear Metals Standard 300 µg/g	Hydrocarbon Oil	200 g	N9308248
V-23 Wear Metals Standard 300 µg/g	Hydrocarbon Oil	400 g	N9308319
V-23 Wear Metals Standard 500 µg/g	Hydrocarbon Oil	100 g	N9308249
V-23 Wear Metals Standard 500 µg/g	Hydrocarbon Oil	200 g	N0776106
V-23 Wear Metals Standard 500 µg/g	Hydrocarbon Oil	400 g	N9308320
V-23 Wear Metals Standard 900 µg/g	Hydrocarbon Oil	100 g	N9308251
V-23 Wear Metals Standard 900 µg/g	Hydrocarbon Oil	200 g	N9308252
V-23 Wear Metals Standard 900 µg/g	Hydrocarbon Oil	400 g	N9308321

V-26 Wear Metal Standards

Includes: Ag, Al, B, Ba, Bi, Ca, Cd, Cr, Cu, Fe, In, Li, K, Mg, Mn, Mo, Na, Ni, P, Pb, Sb, Si, Sn, Ti, V, Zn

Description	Matrix	Size	Part No.
V-26 Wear Metals Standard 10 µg/g	Hydrocarbon Oil	100 g	N0776130
V-26 Wear Metals Standard 10 µg/g	Hydrocarbon Oil	200 g	N0776131
V-26 Wear Metals Standard 10 µg/g	Hydrocarbon Oil	400 g	N9308743
V-26 Wear Metals Standard 30 µg/g	Hydrocarbon Oil	100 g	N0776132
V-26 Wear Metals Standard 30 µg/g	Hydrocarbon Oil	200 g	N0776133
V-26 Wear Metals Standard 30 µg/g	Hydrocarbon Oil	400 g	N9308745
V-26 Wear Metals Standard 50 µg/g	Hydrocarbon Oil	100 g	N0776134
V-26 Wear Metals Standard 50 µg/g	Hydrocarbon Oil	200 g	N0776135
V-26 Wear Metals Standard 50 µg/g	Hydrocarbon Oil	400 g	N9308747
V-26 Wear Metals Standard 100 µg/g	Hydrocarbon Oil	100 g	N0776136
V-26 Wear Metals Standard 100 µg/g	Hydrocarbon Oil	100 g	N0776137
V-26 Wear Metals Standard 100 µg/g	Hydrocarbon Oil	400 g	N9308742
V-26 Wear Metals Standard 300 µg/g	Hydrocarbon Oil	100 g	N0776138
V-26 Wear Metals Standard 300 µg/g	Hydrocarbon Oil	200 g	N0776139
V-26 Wear Metals Standard 300 µg/g	Hydrocarbon Oil	400 g	N9308744
V-26 Wear Metals Standard 500 µg/g	Hydrocarbon Oil	100 g	N0776140
V-26 Wear Metals Standard 500 µg/g	Hydrocarbon Oil	200 g	N0776141
V-26 Wear Metals Standard 500 µg/g	Hydrocarbon Oil	400 g	N9308746
V-26 Wear Metals Standard 900 µg/g	Hydrocarbon Oil	100 g	N0776142
V-26 Wear Metals Standard 900 µg/g	Hydrocarbon Oil	200 g	N0776143
V-26 Wear Metals Standard 900 µg/g	Hydrocarbon Oil	400 g	N9308748

Setup Solutions

Description	Matrix	Size	Part No.
Setup Solution in Hydrocarbon Oil Contents: Be, Ce, Fe, In, Li, Pb @ 10 µg/g	75 cSt Mineral Oil	100 g	N9308384
Setup Solution in Hydrocarbon Oil Contents: Be, Ce, Fe, In, Li, Pb @ 10 µg/g	75 cSt Mineral Oil	400 g	N9308387

REFERENCE MATERIALS

Metal Additive Standards

Description	Matrix	Size	Part No.
Metal Additive Standard 3: Ca @ 5000 µg/g; P, Zn @ 1600 µg/g	Hydrocarbon Oil	100 g	N9308369
Metal Additive Standard 3: Ca @ 5000 µg/g; P, Zn @ 1600 µg/g	Hydrocarbon Oil	200 g	N9308370
Metal Additive Standard 3: Ca @ 5000 µg/g; P, Zn @ 1600 µg/g	Hydrocarbon Oil	400 g	N9308552
Metal Additive Standard 4: Ca @ 5000 µg/g; Mg, P, Zn @ 1600 µg/g	Hydrocarbon Oil	100 g	N9308259
Metal Additive Standard 4: Ca @ 5000 µg/g; Mg, P, Zn @ 1600 µg/g	Hydrocarbon Oil	200 g	N0776108
Metal Additive Standard 4: Ca @ 5000 µg/g; Mg, P, Zn @ 1600 µg/g	Hydrocarbon Oil	400 g	N9308333
Metal Additives Standard: Ca @ 5000 µg/g; P -Phosphorus @ 1600 µg/g, Zn – Zinc (1600) @ 1600 µg/g	Hydrocarbon Oil	200 g	N9308551



V-Solv™ ICP
Solvent 1 Gallon

Matrix Oils and Solvents

Description	Matrix	Size	Part No.
Hydrocarbon Oil	75 cSt Oil	500 mL	N0776103
Hydrocarbon Oil	75 cSt Oil	1 Gal.	N9308262
Mineral Oil (low sulfur)	20 cSt Mineral Oil	500 mL	N9308263
Mineral Oil (low sulfur)	20 cSt Mineral Oil	1/2 Gal.	N9308264
V-Solv™ ICP Solvent	V-Solv™	1 Gal.	N9308265
V-Solv™ ICP Solvent	V-Solv™	5 Gal.	N9308378
Citrajel Liquid Acid Cleaner		1 Gal.	N0777063
Citrajel Liquid Acid Cleaner		5 Gal.	N0777064
V-Solv™ + Cobalt ICP Solvent	V-Solv™	1 Gal.	N9308198
V-Solv™ + Cobalt ICP Solvent	V-Solv™	5 Gal.	N9308199

Acid Number Standards

Description	Matrix	Size	Part No.
Acid Number (AN) Reference Material, 0.1 mg KOH/g	Hydrocarbon Oil	100 g	N9308160
Acid Number (AN) Reference Material, 0.1 mg KOH/g	Hydrocarbon Oil	400 g	N9308161
Acid Number (AN) Reference Material, 0.5 mg KOH/g	Hydrocarbon Oil	100 g	N9308166
Acid Number (AN) Reference Material, 0.5 mg KOH/g	Hydrocarbon Oil	400 g	N9308167
Acid Number (AN) Reference Material, 1 mg KOH/g	Hydrocarbon Oil	100 g	N9308162
Acid Number (AN) Reference Material, 1 mg KOH/g	Hydrocarbon Oil	400 g	N9308163
Acid Number (AN) Reference Material, 1.5 mg KOH/g	Hydrocarbon Oil	100 g	N9308164
Acid Number (AN) Reference Material, 1.5 mg KOH/g	Hydrocarbon Oil	400 g	N9308165
Acid Number (AN) Reference Material, 2 mg KOH/g	Hydrocarbon Oil	50 g	N9308170
Acid Number (AN) Reference Material, 2 mg KOH/g	Hydrocarbon Oil	400 g	N9308171
Acid Number (AN) Reference Material, 3 mg KOH/g	Hydrocarbon Oil	50 g	N9308168
Acid Number (AN) Reference Material, 3 mg KOH/g	Hydrocarbon Oil	400 g	N9308169

Fuel Dilution Standards

Description	Matrix	Size	Part No.
Blank for Diesel Fuel Dilution Standard	75 cSt Hydrocarbon Oil	100 mL	N9308266
6% w/w Custom Fuel Dilution Standard	75 cSt Hydrocarbon Oil	100 mL	N9308741
Blank for Gas Fuel Dilution Standard	75 cSt Hydrocarbon Oil	100 mL	N9308270
100 µg/g Ethylene Glycol Standard	Multi-grade Diesel Engine Oil	80 mL	N9308388
500 µg/g Ethylene Glycol Standard	Multi-grade Diesel Engine Oil	80 mL	N9308389
600 µg/g Ethylene Glycol QC Standard	Multi-grade Diesel Engine Oil	80 mL	N9308398
1000 µg/g Ethylene Glycol Standard	Multi-grade Diesel Engine Oil	80 mL	N9308396
2000 µg/g Ethylene Glycol Standard	Multi-grade Diesel Engine Oil	80 mL	N9308397
Ethylene Glycol Standards Set	Multi-grade Diesel Engine Oil	6 x 80 mL	N9308399
Ethylene Glycol Standards Set	Multi-grade Diesel Engine Oil	80 mL	N9308379

Devolatilized Diesel Fuel Standards

Description	Matrix	Size	Part No.
2% w/w Devolatilized Diesel Fuel	75 cSt Hydrocarbon Oil	100 mL	N9308151
4% w/w Devolatilized Diesel Fuel	75 cSt Hydrocarbon Oil	100 mL	N9308152
5% w/w Devolatilized Diesel Fuel	75 cSt Hydrocarbon Oil	100 mL	N9308153
10% w/w Devolatilized Diesel Fuel	75 cSt Hydrocarbon Oil	100 mL	N9308154
Custom Fuel Dilution Std. 6% (w/w)	75 cSt Hydrocarbon Oil	100 mL	N9308155
2% w/w Devolatilized Gasoline	75 cSt Hydrocarbon Oil	100 mL	N9308156
5% w/w Devolatilized Gasoline	75 cSt Hydrocarbon Oil	100 mL	N9308157
10% w/w Devolatilized Gasoline	75 cSt Hydrocarbon Oil	100 mL	N9308158

Base Number Standards

Description	Matrix	Size	Part No.
Base Number (BN) Reference Material, 6 mg KOH/g	Hydrocarbon Oil	50 g	N9308554
Base Number (BN) Reference Material, 6 mg KOH/g	Hydrocarbon Oil	400 g	N9308181
Base Number (BN) Reference Material, 10 mg KOH/g	Hydrocarbon Oil	50 g	N9308555
Base Number (BN) Reference Material, 10 mg KOH/g	Hydrocarbon Oil	400 g	N9308173
Base Number (BN) Reference Material, 15 mg KOH/g	Hydrocarbon Oil	50 g	N9308174
Base Number (BN) Reference Material, 30 mg KOH/g	Hydrocarbon Oil	50 g	N9308176
Base Number (BN) Reference Material, 30 mg KOH/g	Hydrocarbon Oil	400 g	N9308177
Base Number (BN) Reference Material, 40 mg KOH/g	Hydrocarbon Oil	50 g	N9308178
Base Number (BN) Reference Material, 70 mg KOH/g	Hydrocarbon Oil	50 g	N9308182
Base Number Standard 15 mg KOH/g	Hydrocarbon Oil	400 g	N9308175
Base Number Standard 30 mg KOH/g	Hydrocarbon Oil	50 g	N9308553
Base Number Standard 40 mg KOH/g	Hydrocarbon Oil	400 g	N9308179
Base Number Standard 70 mg KOH/g	Hydrocarbon Oil	400 g	N9308133



Dilution Oil



Karl Fischer Standards

Karl Fischer Standards

Nominal Water Concentration (%)	Matrix	Size	Part No.
Karl Fischer Water in Oil, 0.05%	10W30 Motor Oil	100 mL	N9308298
Karl Fischer Water in Oil, 0.1%	10W30 Motor Oil	100 mL	N9308279
Karl Fischer Water in Oil, 0.5%	10W30 Motor Oil	100 mL	N9308280
Karl Fischer Water in Oil, 1.0%	10W30 Motor Oil	100 mL	N9308281

Crackle Test Reference Standards

Description	Matrix	Size	Part No.
Crackle Test Reference Standard 0 wt% H ₂ O	10W30 Motor Oil	100 g	N9308337
Crackle Test Reference Standard 0.1 wt% H ₂ O	10W30 Motor Oil	100 g	N9308338
Crackle Test Reference Standard 0.5 wt% H ₂ O	10W30 Motor Oil	100 g	N9308339

Soot Content Standards

Nominal Soot Content Range (%)	Matrix	Size	Part No.
Nominal Soot Content Range: Blank	15W40 Diesel Oil	50 mL	N9308282
Nominal Soot Content Range: 0.5-2%	15W40 Diesel Oil	50 mL	N9308283
Nominal Soot Content Range: 2-4%	15W40 Diesel Oil	50 mL	N9308284
Nominal Soot Content Range: 4-6%	15W40 Diesel Oil	50 mL	N9308285

Soot Content Standard Set

Nominal Soot Content Range (%)	Matrix	Size	Part No.
Nominal Soot Content Range: 0.0, 0.5-2, 2-4, 4-6, 6-9, 9-12wt%	15W40 Diesel Oil	6 x 50 mL	N9308730

OilExpress Standards

Description	Matrix	Size	Part No.
In-Service Lubricants FT-IR Control Standard	15W40 Diesel Oil	100 mL	N9308350
In-Service Lubricants FT-IR Control Standard	15W40 Diesel Oil	500 mL	N9308375
OilExpress 4 Test Oil 120 cSt	PAO Oils	500 mL	N9308351
OilExpress 4 Test Oil 360 cSt	PAO Oils	100 mL	N9308352
OilExpress 4 System Liquid Detergent Additive		100 mL	N9308354
OilExpress 4 System Liquid Detergent Additive		500 mL	N9308376
OilExpress 4 System Liquid Detergent Additive		1 Gal.	N9308380
Pathlength Calibration Fluid (Squalane)		50 mL	N9308377
OilExpress 4 Installation Kit (includes N9308350 , N9308351 , N9308352 , N9308354 , and N9308377)			N9300850

Viscosity Reference Standards

Description	Matrix	Size	Part No.
Viscosity Standard Reference Kit Kit includes: N5316001 , N5316002 , N5316003 , N5316004 , N5316005	Hydrocarbons	5 x 500 mL	N5316000
Nominal Viscosity: 4.5 cSt at 40 °C and 1.6 cSt at 100 °C	Hydrocarbons	500 mL	N9307740
Nominal Viscosity: 10 cSt at 40 °C and 2.7 cSt at 100 °C	Hydrocarbons	500 mL	N5316001
Nominal Viscosity: 30 cSt at 40 °C and 5.3 cSt at 100 °C	Hydrocarbons	500 mL	N5316002
Nominal Viscosity: 30 cSt at 40 °C and 5.3 cSt at 100 °C	Hydrocarbons	1 Gal.	N5316025
Nominal Viscosity: 100 cSt at 40 °C and 16.8 cSt at 100 °C	Hydrocarbons	500 mL	N5316003
Nominal Viscosity: 100 cSt at 40 °C and 16.8 cSt at 100 °C	Hydrocarbons	1 Gal.	N5316024
Nominal Viscosity: 360 cSt at 40 °C and 42 cSt at 100 °C	Hydrocarbons	500 mL	N5316004
Nominal Viscosity: 930 cSt at 40 °C and 82 cSt at 100 °C	Hydrocarbons	500 mL	N5316005

Biodiesel Standards

Description	Matrix	Size	Part No.
Biodiesel Blank	B100 Biodiesel	100 mL	N9308286
Biodiesel Blank	B100 Biodiesel	500 mL	N9308287
Sulfur @ 20 µg/g in Biodiesel	B100 Biodiesel	100 mL	N9308288
Metals in Biodiesel – Ca, K, Mg, Na, P @ 20 µg/g	B100 Biodiesel	100 g	N9308289
Multi-Element Biodiesel Standard 5 µg/g, Ca, K, Mg, Na, P	B100 Biodiesel	100 g	N9308726

Biodiesel Blends

Description	Matrix	Size	Part No.
100% High Cetane Diesel	High Cetane Diesel Fuel	20 mL	N9308290
2% (v/v) Biodiesel	High Cetane Diesel Fuel	20 mL	N9308291
5% (v/v) Biodiesel	High Cetane Diesel Fuel	20 mL	N9308292
10% (v/v) Biodiesel	High Cetane Diesel Fuel	20 mL	N9308293
15% (v/v) Biodiesel	High Cetane Diesel Fuel	20 mL	N9308294
20% (v/v) Biodiesel	High Cetane Diesel Fuel	20 mL	N9308295
100% (v/v) Biodiesel	B100 Biodiesel	20 mL	N9308296

Sulfur Standards

Description	Matrix	Size	Part No.
Polysulfide Oil Blank	13 cSt Mineral Oil	500 mL	N9308390
Sulfur @ 500 µg/g, from Polysulfide Oil	13 cSt Mineral Oil	500 mL	N9308391
Sulfur @ 1000 µg/g, from Polysulfide Oil	13 cSt Mineral Oil	500 mL	N9308392
Sulfur @ 5000 µg/g, from Polysulfide Oil	13 cSt Mineral Oil	500 mL	N9308393
Sulfur @ 1 wt%, from Polysulfide Oil	13 cSt Mineral Oil	500 mL	N9308394
Sulfur @ 5 wt%, from Polysulfide Oil	13 cSt Mineral Oil	500 mL	N9308395
Sulfur @ 0 µg/g (Blank)	#2 Diesel Fuel	500 mL	N9308714
Sulfur @ 5 µg/g, from Polysulfide Oil	#2 Diesel Fuel	500 mL	N9308715
Sulfur @ 10 µg/g, from Polysulfide Oil	#2 Diesel Fuel	500 mL	N9308716
Sulfur @ 15 µg/g, from Polysulfide Oil	#2 Diesel Fuel	500 mL	N9308717
Sulfur @ 20 µg/g, from Polysulfide Oil	#2 Diesel Fuel	500 mL	N9308718
Sulfur @ 25 µg/g, from Polysulfide Oil	#2 Diesel Fuel	500 mL	N9308719
Sulfur @ 50 µg/g, from Polysulfide Oil	#2 Diesel Fuel	500 mL	N9308720
Sulfur @ 100 µg/g, from Polysulfide Oil	#2 Diesel Fuel	500 mL	N9308721
Sulfur @ 500 µg/g, from Polysulfide Oil	#2 Diesel Fuel	500 mL	N9308722
Sulfur @ 1000 µg/g, from Polysulfide Oil	#2 Diesel Fuel	500 mL	N9308723
Sulfur @ 1500 µg/g, from Polysulfide Oil	#2 Diesel Fuel	500 mL	N9308724
Sulfur at 3.00wt% in Heavy Mineral Oil	75 cSt Mineral Oil	100 mL	N9307739
Sulfur @10 µg/g in B100 Biodiesel	B100 Biodiesel	100 mL	N9308727

Petroleum Physical Test Standard

Description	Matrix	Size	Part No.
ASTM D86 Distillation Standard	Diesel Fuel	500 mL	N9308728

Detection Limit Calibration Standard

Description	Matrix	Size	Part No.
Detection Limits Calibration Standard: a, Mg @ 5 µg/g; La, Li, Mn, Ni, Sr, Zn @ 50 µg/g; As, K @ 250 µg/g	Hydrocarbon Oil	4 oz.	N9307102

Coolant Standards

Matrix	Content	Volume	Part No.
Custom Standard HI 1A			
3% HNO ₃ (v/v)	Al @ 10 µg/mL, Mg @ 20 µg/mL, Ca @ 32 µg/mL, Cu, Fe, Pb, Zn @ 50 µg/mL, B @ 1000 µg/mL, P @2000 µg/mL, K @ 5000 µg/mL, Na @10,000 µg/mL	500 mL	N9308341
Custom Standard QC 1A			
3% HNO ₃ (v/v)	Al, Cu @5 µg/mL, Mg @ 10 µg/mL, Zn @ 20 µg/mL, Fe, Pb @ 25 µg/mL, Ca @ 50 µg/mL, B @ 250 µg/mL, P @1000 µg/mL, K @ 2500 µg/mL, Na @ 5000 µg/mL	500 mL	N9308342
Custom Standard LO 1A			
3% HNO ₃ (v/v)	Al, Cu @ 2 µg/mL, Mg, Zn @ 4 µg/mL, Fe, @ 5 µg/mL, Ca, Pb@ 10 µg/mL, B @ 50 µg/mL, P @ 400 µg/mL, K, Na @ 1000 µg/mL	500 mL	N9308343
Custom Standard QC 1B			
3% HNO ₃ (v/v)/ trace HF	Sn @ 10 µg/mL, Si @ 30 µg/mL, Mo @ 50 µg/mL	500 mL	N9308344
Custom Standard LO 1B			
3% HNO ₃ (v/v)/ trace HF	Sn @ 5 µg/mL, Si @ 10 µg/mL, Mo @ 20 µg/mL	500 mL	N9308345
Custom Standard HI 1B			
3% HNO ₃ (v/v)/ trace HF	Sn @ 20 µg/mL, Mo, Si @ 100 µg/mL	500 mL	N9308346

Proficiency Testing Standards

Proficiency Testing Program

The Proficiency Testing Program offered by PerkinElmer has been designed to provide laboratories with a method of monitoring their analytical performance as measured against Certified Reference Materials (CRMs).



Proficiency Testing Standards

1. Analyze a sample
2. Report the results online
3. Receive an instant response to submitted values

Confirm the accuracy of your analytical results, quickly, easily and definitively.

Description	Size	Part No.
PTP Standard for Elemental Analysis of Oils	25 g	N9308314

Note: Analyze a sample for up to 23 common elements and report the concentrations in µg/g (ppm). Enter all elements or only those that are of interest to you. Results are color-coded pass/fail indications in green (pass), yellow (borderline) and red (fail).

Description	Size	Part No.
Sample for Particle Count Analysis	125 mL	N9308725

Note: Particle count PTP test standards includes 8 channels (4,6,8,14,21,38, 50 and 70 µm). One bottle for ISO 11171 only.

Description	Size	Part No.
Viscosity PTP Test Standard	50 mL	N9308540

Note: Report viscosity values in cSt at 40 °C, 100 °C, or both

ICP-MS Single Cell Sample Introduction Kits

The Single Cell Application Module within PerkinElmer's Syngistix™ for ICP-MS software is the ideal tool for laboratories analyzing metal content in cells, either from bioaccumulation of metals or metallic nanoparticles in solution or measuring the intrinsic metal content of the cell. This unique combination of hardware and software module allows the differentiation and quantification between the media and cellular fractions of the same analyte. In a single analysis, cell metal or particulate content, cell-containing metal concentration, mass per cell and mass distribution can all be determined without the need for subsequent data processing. Coupled with the NexION® series ICP-MS, the Syngistix Single Cell Application Module is the world's first single cell ICP-MS dedicated software, delivering speed, flexibility, automation and ease-of-use.



Single Cell Micro DX Autosampler



Asperon Spray Chamber



Description	Qty.	Part No.
Single Cell Kit for NexION 1000/2000		N8150032
Kit Includes:		
Asperon™ Spray Chamber	1	N8152493
Spray Chamber Drain Line	1	N8152494
Spray Chamber Addition Gas Tee 1/8 Fitting	1	N8152495
Nebulizer HEN	1	N8152496
Sample Line for HEN MEINHARD® Nebulizer	1	N8152489
UV Light Shield	1	N8152497
Plasma Light Shield	1	N8152377
Fixed 2.0 mm Injector UHP Quartz Torch	1	N8152428
Torch Cassette White	1	N8152432
Torch Injector Nut	1	N8152451
Syngistix Single Cell Software	1	N8150321
CTFE Male Barb Fitting	2	N8145017
CTFE Female Barb Fitting	2	N8145018
Orange/Red 0.19 mm i.d. PVC Pkg.12	1	N8152401
MP ² PVC Flared 0.19mm Orange/Red Pkg.12	1	N8145195
Autosampler Probe 0.15 mm	1	N077221

Description	Part No.
Single Cell Automation Kit for NexION 1000/2000	N8150039
Kit Includes:	
Includes Single Cell Micro DX Autosampler. Does not include Single Cell Kit (N8150032)	

Description	Qty.	Part No.
Single Cell Kit for NexION 350		N8140032
Kit Includes:		
Asperon™ Spray Chamber	1	N8152493
Spray Chamber Drain Line	1	N8152494
Sample Line for HEN MEINHARD® Nebulizer	1	N8152489
Spray Chamber Gas Fitting	1	N8142045
Nebulizer Hen	1	N8142046
UV Light Shield	1	N8142047
Quartz Injector 2 mm	1	N8145508
Syngistix Single Cell Software	1	N8150321
CTFE Male Barb Fitting	2	N8145017
CTFE Female Barb Fitting	2	N8145018
0.19 mm ID Orange/Red Flared PVC Pkg. 12	1	N0773111
Autosampler Probe, 0.15 mm	1	N0777221
Not Included in the Kit		
Make-up Gas Mass Flow Controller Upgrade		W1028686

Description	Part No.
Single Cell Automation Kit for NexION 300/350	N8140039
Kit Includes:	
Includes Single Cell Micro DX Autosampler. Does not include Single Cell Kit (N8140032)	

Sample Preparation Blocks and Titan MPS

Sample preparation is one of the most critical steps in the analytical process. Often accounting for 60% of your timetable, it has a fundamental impact on laboratory throughput and analytical performance. Any errors within the sample preparation process will undermine the quality of your data at all subsequent stages of your analysis. At PerkinElmer, we provide you with a portfolio of sample preparation solutions that ensure sample preparation success.

Quick Reference Index Page

▶ Sample Preparation Blocks and Controllers	131
▶ SPB Start Up Kits	132
▶ DigiFILTERs	132
▶ DigiTUBES	133
▶ Watch Glasses	133
▶ Titan MPS Systems and Accessories	135
▶ Turntables	136
▶ Vessels and Vessel Caps	136
▶ Consumable Run Kits	137

Sample Preparation Blocks and Controllers

Better laboratory practices demand modern techniques in sample preparation. In the past, hot plates were used to digest samples where common digestion problems involved rusting, cross contamination of digestion system to sample, and poor sample temperature control.



▶ [VIEW PAGE](#)

Titan MPS Systems

With the Titan MPS™ microwave sample preparation system, we're delivering on the promise of a simple, safe, cost-effective microwave – one that provides the quick return on investment that labs are looking for in these times of constrained budgets. The Titan MPS microwave sample preparation system delivers the instrument-ready solutions you need for high throughput and reliable results.



▶ [VIEW PAGE](#)

Tubes and Vessels

PerkinElmer offers a complete selection of consumables and supplies for your Sample Preparation products.

▶ [VIEW PAGE](#)



Open Digestion

Ideal for: Liquid and solid samples in regulated industries.

Common Applications: water, soil and food testing.

Overview: Open vessel, atmospheric pressure digestion is a common approach to sample preparation for regulatory and compliance laboratories. With the ability to prepare large quantities of samples, open digestion is great for labs with modest digestion requirements that rely on high throughput. Hot block digestion using open vessels meets the regulatory requirements for sample extraction and a number of approved methods are in place to support this.

All PerkinElmer sample preparation blocks are manufactured under a certified ISO 9001: 2008 Quality Management System to meet our high quality requirements.

Upgrade from a Hot Plate: Better laboratory practices demand modern techniques in sample preparation. In the past, hot plates were used to digest samples where common digestion problems involved low throughput, dealing with fragile beakers, cleanliness of glassware, rusting and corrosion, cross contamination of digestion system to sample, loss of volatile elements and poor sample temperature control.

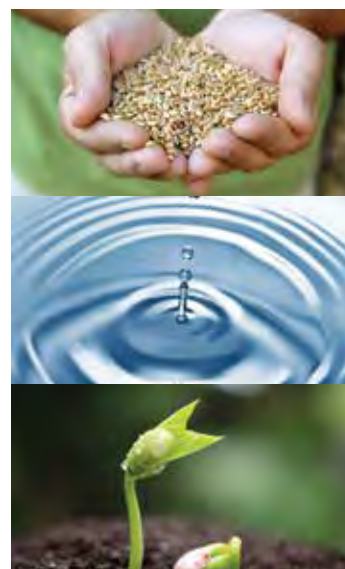

Sample Preparation Blocks

The SPB series of block digestion systems offers the latest in graphite block technology in many different packages. Graphite blocks are PTFE-coated to resist aggressive corrosive attack for guaranteed long life in harsh laboratory environments.

Our sample blocks operate with either a SPB Digital Controller or SPB Touch Controller*. Please select a controller below and the appropriate Start Up Kit* which includes RackLock DigiTUBE®s, disposable watch glasses, DigiFILTER™s and much more. Each SPB Block includes one set of racks.

Description	Capacity	Part No.
SPB 15-40, (115 V/230 V)	40 Tubes/15 mL	N9300800
SPB 15-108, (115 V/230 V)	108 Tubes/15 mL	N9300801
SPB 50-24, (115 V/230 V)	24 Tubes/50 mL	N9300802
SPB 100-12, (115 V/230 V)	12 Tubes/100 mL	N9300805
SPB 50-48, (115 V/230 V)	48 Tubes/50 mL	N9300803
SPB 100-30, (115 V/230 V)	30 Tubes/100 mL	N9300806
SPB 50-72, (230 V)	72 Tubes/50 mL	N9300804
SPB 100-42, (230 V)	42 Tubes/100 mL	N9300807

*Sold separately



Controllers

The user friendly SPB Digital Controller includes programmable features such as: temperature set-point to 0.1 °C, even sample heating and evaporation results, timer shutdown option and programmable alarm for end of cycle.

The SPB Touch Controller includes all of the SPB Digital Controller features and more. Added features include: a graphical representation of the heating profile in real-time to identify the current stage of the method heating program. Safety features include the ability of the controller to monitor the heating cycle of the block to prevent run away situations. The controller allows for the SPB Probe to be calibrated to meet your SOP requirements.

The SPB Probe, used with either the Digital or Touch models, can directly monitor and control the block's heating rate via sample temperature feedback to the controller.

Description	Part No.
SPB Digital Controller	N9300808
SPB Touch Controller	N9300809



Start Up Kits

PerkinElmer's SPB Start Up kits contain all consumable items required to operate the system including: RackLock DigiTUBE®s and Caps, disposable Watch Glasses, DigiFILTER™s, RackLock Racks and Storage Racks.

Description	DigiTUBEs /Caps	Watch Glasses	Racks	Part No.
Start Up Kit for SPB 15-40	540	—	2	N9308704
Start Up Kit for SPB 15-108	540	—	2	N9308706
Start Up Kit for SPB 50-24	500	1000	1	N9308017
Start Up Kit for SPB 100-12	200	500	1	N9308011
Start Up Kit for SPB 50-48	500	1000	2	N9308002
Start Up Kit for SPB 100-30	200	500	2	N9308013
Start Up Kit for SPB 50-72	500	1000	3	N9308025
Start Up Kit for SPB 100-42	200	500	2	N9308015



Automatic Shut-Off System

Designed to shut-off SPB systems with no lab supervision. Ideal for overnight digestions and evaporations where samples require volume reductions (volume control ± 2.5 mL). Increase lab efficiency by automatically digesting samples off-hours. Select appropriate Probe for Tube use.

Description	Qty.	Part No.
TempSET, without Probe	1	N9300810
TempSET Probe for 50 mL Tubes	1	N9308023
TempSET Probe for 100 mL Tubes	1	N9308029
TempSET Probe Holder for 100 mL Tubes	1	N9308065



Temperature Probes

Why use a thermometer to monitor and manually adjust sample temperature when a SPB Probe will automatically do the job? The SPB Probe provides direct control and monitoring of actual sample temperature via a corrosion-resistant, PFA-coated temperature probe. Available with different holders in a 6 in. configuration for use with 50 and 100 mL DigiTUBEs. Each probe is supplied with five Probe Watch Glasses and a probe holder.

Description	Qty.	Part No.
SPB Probe 6 in. for 15 mL Tubes	1	N9308707
SPB Probe 6 in. for 50 mL Tubes	1	N9308018
SPB Probe 6 in. for 100 mL Tubes	1	N9308009
SPB Probe Watch Glass (replacement) for 50 mL Tubes	25	N9308041
SPB Probe Watch Glass (replacement) for 100 mL Tubes	25	N9308073
SPB Probe Holder for DigiTUBEs 15 mL	1	N9308703
SPB Probe Holder for DigiTUBEs 50 mL	1	N9308044
SPB Probe Holder for DigiTUBEs 100 mL	1	N9308045



DigiFILTER

The vacuum assisted DigiFILTER assembly provides a quick and easy way to filter samples prior to analysis. Increase lab productivity by filtering particulates from digested samples in a matter of seconds directly from the digestion tube. Available with a 0.45 or 1.0 μ hydrophilic PTFE membrane. Field Filtration Kit conforms to Item 8.2 in the EPA 200.7, 200.8 and 200.9 Methods.

Description	Qty.	Part No.
DigiFILTER 0.45 micron for 50 mL DigiTUBEs	100	N9308031
DigiFILTER 1.0 micron for 50 mL DigiTUBEs	100	N9308032
Field Filtration Kit 0.45 for 50 mL DigiTUBEs Contains: 25 0.45 μ DigiFILTERs, 30 x 50 mL DigiTUBEs, 1 x 6 mL bottle of PlasmaPURE® Nitric acid, 1 x 50 mL storage rack, 1 Sharpie® pen and 2 x 60 mL plastic syringes	1	N9308033
DigiFILTER Manifold	1	N9308034

Tubes, Caps and Watch Glasses

PerkinElmer offers 50 and 100 mL, disposable, sample digestion tubes with easy-to-read graduations. Accurate 50 or 100 mL graduation is calibrated to meet Class A specifications to allow normalization directly in the tube. RackLock design allows for easy, one-handed closure of leak-free screw cap. All-in-one tubes eliminate the need for five separate vessels: Digestion beakers, volumetric flasks, graduated cylinders, autosampler tubes and storage containers.



DigiTUBEs

DigiTUBE	Dimensions (OD/ID)
15 mL	12 mm x 11 mm
50 mL	30 mm x 28 mm
100 mL	46 mm x 44 mm

Description	Qty.	Part No.
DigiTUBEs 15 mL with RackLock (incl. caps)	1620	N9308711
DigiTUBEs 15 mL with RackLock (no caps)	1620	N9308712
DigiTUBEs 15 mL with RackLock (incl. caps)	540	N9308713
DigiTUBEs 50 mL with RackLock (incl. caps)	750	N9308008
DigiTUBEs 50 mL non-RackLock (incl. caps)	750	N9308037
DigiTUBEs 50 mL with RackLock (no caps)	750	N9308340
DigiTUBEs 100 mL with RackLock (incl. caps)	300	N9308016
DigiTUBEs 100 mL non-RackLock (incl. caps)	300	N9308066
PTFE Digestion Tube 50 mL (incl. Blue caps)	6	N9308024
Tube, Quartz, 62.5 mL, Uncalibrated	6	N9308048
Tube, Borosilicate, 62.5 mL, Uncalibrated	6	N9308049
Tube, Borosilicate, 62.5 mL, Calibrated at 50 mL	6	N9308050

VersaTube™

A unique, patented tube with attached cap – simplifying digestion analysis and no watch glasses are required.

- Integrated cap and vial – single unit design of cap and vial which is easily manipulated with one hand.
- Ability to vent samples with cap – the attached cap can ‘lock’ open at an angle, which enables venting of your sample if desired. No watch glasses required.
- Certified accuracy of graduations and levels of trace metals – graduations in 5 mL increments to 50 mL, certification of accuracy available.
- Heat resistant homopolymer polypropylene – for good heat resistance and minimal background interference.
- Etched cap surface for writing – provides labeling area on the cap for sample identification.
- Ready to use out of the box – limits possible contamination with improved efficiency.



Description	Qty.	Part No.
VersaTube 50 mL	500	N9308383



Screw Caps

Description	Qty.	Part No.
Screw Caps, Blue, for 15 mL DigiTUBEs	540	N9308705
Screw Caps, Clear, for 15 mL DigiTUBEs	540	N9308708
Screw Caps, Orange, for 50 mL DigiTUBEs	250	N9308058
Screw Caps, Red, for 50 mL DigiTUBEs	250	N9308059
Screw Caps, Clear, for 50 mL DigiTUBEs	250	N9308060
Screw Caps, Yellow, for 50 mL DigiTUBEs	250	N9308056
PTFE Screw Cap for PTFE 50 mL Digestion Tube	6	N9308027



Watch Glasses

Description	Qty.	Part No.
Disposable Watch Glasses, 50 mL	1000	N9308003
Disposable Watch Glasses, 100 mL	500	N9308030

SAMPLE PREPARATION

SPB Block Racks

For busy labs, additional acid resistant, polycarbonate Racks are available for all SPB systems. Exclusive RackLock feature locks DigiTUBE®s in position within the rack allowing for easy, one-handed closure of screw cap.



Foam Storage Rack
Part No. **N9308382**



DigiTUBE Rack

Storage Racks

Description	Qty.	Part No.
40-Position Rack for SPB 15-40, 15 mL	1	N9308700
54-Position Rack for SPB 15-108, 15 mL	1	N9308701
12-Position Rack for SPB-100-12, 100 mL	1	N9308067
15-Position Rack for SPB-100-30, 100 mL	1	N9308068
21-Position Rack for SPB-100-42, 100 mL	1	N9308069
24-Position Rack for SPB-50-24, 50 mL	1	N9308070
24-Position Rack for SPB-50-48 and SPB-50-72, 50 mL	1	N9308042

Description	Qty.	Part No.
Foam Storage Rack 15 mL	5	N9308702
Plastic Storage Rack 50 mL	5	N9308381
Foam Storage Rack 100 mL	5	N9308382

Fume Hoods and Accessories

The bench top fume hoods for SPB systems are the right choice for trace-metal digestions. Made from clear, acid resistant polycarbonate with a solid surface material base, the fume hood eliminates the risk of trace-metal contamination common with traditional fume hoods. HEPA® filters ensure clean input air. The fume hood can be connected to an in-house laboratory exhaust system or used with the SPB blower unit (**N9308022**). Fume hoods come flatpacked to save transport costs and can be assembled in minutes without tools.



SPBVAC Block

Description	Part No.
Fume Hood for SPB 50-24/100-12, 50-48 / 100-30 23.5 in. D x 26 in. W x 20 in. H	N9308000
Fume Hood for SPB 50-72/100-42 28 in. D x 27 in. W x 20 in. H Filter for SPB Fume Hoods N9308078	N9308001
Fume Hood II for Autosampler 23.5 in. D x 26 in. W x 25 in. H	N9308036
SPBVAC™ Evacuation Hood, mounts directly on SPB 50-48/SPB 100-30	N9308021
SPB Blower Unit, for use with all systems	N9300811
Vacuum Pump 20 L/min 115 V	N9308035
Vacuum Pump 60 L/min 115 V	N9308063
Vacuum Pump 17 L/min 230 V	N9308331
Vacuum Pump 58 L/min 230 V	N9308332



Part No.
N9308063

Microwave Digestion

Ideal for: Difficult sample types and regulated laboratories.

Common Applications: Plant waste streams, alloys, pigments, simple and precious metal ores and heavy organic samples.

Overview: Microwave digestion provides high-performance, pressure digestion using sealed vessels to deliver complete sample digestion, allowing total elemental measurement. Able to digest difficult sample types quickly and completely, microwave digestion provides the most accurate sample preparation. Using ultra-clean sealed digestion vessels, the Titan MPS avoids loss of volatile analytes and prevents sample contamination from the working environment. With its high performance, microwave digestion is ideal for mining/geologic, environmental, petrochemical and pharmaceutical industries.

The Titan MPS microwave sample preparation system delivers the instrument-ready solutions you need for high throughput and reliable results. With its Direct Pressure Control™ (DPC) and Direct Temperature Control™ (DTC) sensing technologies, the Titan MPS system accurately monitors digestion reactions and the sample temperature in each digestion vessel to provide outstanding reaction control and deliver consistent digestion results.



Titan MPS Systems

Before you prepare your first sample, you'll notice the difference: The Titan MPS is a top-loading microwave sample preparation system protected by hardware interlocks to ensure safety during operation. And it's simple to load and unload samples, which keeps everyone more productive – and saves your lab time and money.

Description	Part No.
Titan MPS Standard Pressure 16-Position, (230V 50/60Hz) Includes: 16-Position turntable, gas containment manifold, 16 standard pressure 75 mL (40 bar) digestion vessels, 15 vessel caps without pressure sensor, 1 vessel cap with pressure sensor, a lip seal forming tool, exhaust hose, consumables for approximately 500 runs, power cord (US)	N3130100
Titan MPS High Pressure 8-Position, (230V 50/60Hz) Includes: 8-Position turntable, gas containment manifold, 8 high pressure 100 mL (100 bar) digestion vessels, 8 TFM sample vessel inserts, 8 ceramic pressure jackets, 7 vessel caps without pressure sensor, 1 vessel cap with pressure sensor, a vessel opening station, a lip seal forming tool, exhaust hose, consumables for approximately 500 runs, power cord (US)	N3130110



System Accessories

Description	Part No.
External Exhaust System 230V 50/60 Hz Optional accessory for exhausting Titan MPS oven cavity in laboratories that do not have exhaust systems. Includes one 1.5 m exhaust tube. ID 76 mm, OD 82 mm	N3131009
Exhaust Tube 1.5 m (one included with Titan)	N3134015
Titan MPS Bench The Titan MPS bench is a heavy-duty Chemsurf laminated rolling cart. The top working surface is constructed with durable Chemsurf material, a chemically-resistant laminate specifically designed for applications in laboratories with routine exposure to chemicals. A full lower shelf with durable Chemsurf laminate provides storage space for digestion vessels and other Titan MPS spares and accessories. Locking 4 in. diameter casters provide stability and easy movement. Dimensions: 32 in. D x 30 in. W x 29 in. H	N0777900

SAMPLE PREPARATION



Part No.
N3131010



Part No.
N3131011



Part No.
N3132011



Part No.
N3132013



Part No.
N3132015

Turntables

Description	Part No.
16-Position Turntable with Standard 75 mL (40 Bar) Digestion Vessels, with DPC (complete)	N3131010
16-Position Turntable with Standard 75 mL (40 Bar) Digestion Vessels, without DPC (complete)	N3131005
16-Position Turntable for Standard 75 mL (40 Bar) Digestion Vessels (turntable only)	N3131006
8-Position Turntable with High Pressure 100 mL (100 Bar) Digestion Vessels, with DPC (complete)	N3131011
8-Position Turntable with High Pressure 100 mL (100 Bar) Digestion Vessels, without DPC (complete)	N3131007
8-Position Turntable for High Pressure 100 mL (100 Bar) Digestion Vessels (turntable only)	N3131008



Part No.
N3133017



Part No.
N3133019

Accessories

Description	Part No.
High Pressure 100 mL (100 Bar) Digestion Vessel Opening Station	N3133017
Single Lip Seal Forming Tool for Standard 75 mL (40 Bar) Digestion Vessel Pressure Seals	N3132015
8-Position Lip Seal Forming Tool for Standard 75 mL (40 Bar) Digestion Vessel Pressure Seals. Forms up to 8 Seals Simultaneously	N3132014
8-Position Lip Seal Forming Tool for High Pressure 100 mL (100 Bar) Digestion Vessel Pressure Seals. Forms up to 8 Seals Simultaneously	N3133018
Single Lip Seal Forming Tool for High Pressure 100 mL (100 Bar) Digestion Vessel Pressure Seals. Forms 1 Seal	N3133019
PTFE 2 mL Sample Weighing Cup for Use in Standard 75 mL (40 Bar) or High Pressure 100 mL (100 Bar) Digestion Vessel, Qty. 1	N3134009
PTFE 2 mL Sample Weighing Cup for Use in Standard 75 mL (40 Bar) or High Pressure 100 mL (100 Bar) Digestion Vessel, Qty. 16	N3134010
Vessel Cap Disassembly Tools for Standard 75 mL (40 Bar) Digestion Vessel	N3134011
Vessel Cap Disassembly Tools for High Pressure 100 mL (100 Bar) Digestion Vessel	N3134012

Vessels and Vessel Caps

Description	Qty.	Part No.
Standard 75 mL (40 Bar) Digestion Vessel with DPC (Complete) Includes: Pressure Seal, Vessel Cap with DPC, Rupture Disc and Vessel Base	1	N3132010
Standard 75 mL (40 Bar) Digestion Vessel without DPC. Includes: Pressure Seal, Vessel Cap, Rupture Disc and Vessel Base	1	N3132009
Standard 75 mL (40 Bar) Digestion Vessel TFM Base (base only)	1	N3132011
TFM Cap for Standard 75 mL (40 Bar) Digestion Vessels without Pressure Sensor	1	N3132012
TFM DPC Cap for Standard 75 mL (40 Bar) Digestion Vessels with Pressure Sensor	1	N3132013
High Pressure 100 mL (100 Bar) Digestion Vessel without DPC (complete) Includes: Pressure seal, Vessel cap, Rupture Disc, TFM Vessel Insert, Ceramic Pressure Jacket and Vessel Base	1	N3133012
High Pressure 100 mL (100 Bar) Digestion Vessel with DPC (complete) Includes: Pressure seal, Closure Cap with DPC, Rupture Disc, TFM Vessel Insert, Ceramic Pressure Jacket and Vessel Base	1	N3133013
High Pressure 100 mL (100 Bar) Digestion Vessel Base (base only)	1	N3133014
TFM Cap for High Pressure 100 mL (100 Bar) Digestion Vessels without Pressure Sensor	1	N3133015
TFM DPC for High Pressure 100 mL (100 Bar) Digestion Vessels with Pressure Sensor	1	N3133016



Vessel Rack Holder

Vessel rack holder for Titan 75 mL vessels. Acrylic box holds eight 75 mL vessels.

Description	Part No.
75 mL Vessel Rack Holder	N3134094



Spares and Replacement Parts

Description	Part No.
Rupture Disc for Standard 75 mL (40 Bar) Digestion Vessels. Made of aluminum, set of 25 pcs	N3132001
Rupture Disc for High Pressure 100 mL (100 Bar) Digestion Vessels. Made of titanium, set of 10 pcs	N3133022
Pressure Seal for Standard 75 mL (40 Bar) Digestion Vessels. Made of TFM, set of 10 pcs	N3132002
Pressure Seal for High Pressure 100 mL (100 Bar) Digestion Vessels. Made of TFM, set of 5 pcs	N3133023
DPC Glass Prism for Standard or High Pressure Digestion Vessels	N3132004
DPC Glass-Ring for Standard 75 mL (40 Bar) Digestion Vessel	N3132003
DPC Glass-Ring for High Pressure 100 mL (100 Bar) Digestion Vessel	N3133003
DPC Polarization Foil for Digestion Vessel Caps with Pressure Control for Standard 75 mL (40 Bar) and High Pressure 100 mL (100 Bar) Digestion Vessel, set of 24 pcs	N3132005
DPC TFM Cap Insert for Standard 75 mL (40 Bar) Digestion Vessel	N3132006
DPC TFM Cap Insert for High Pressure 100 mL (100 Bar) Digestion Vessel	N3133006
DPC Clamp Screw for Glass Prism for Standard 75 mL (40 Bar) Digestion Vessel	N3132007
DPC ClampScrew for Glass Prism for High Pressure 100 mL (100 Bar) Digestion Vessel	N3133007
DPC Viton O-Ring (25 x 3 mm) for Digestion Vessel caps with Pressure Control for Standard 75 mL (40 Bar) Digestion Vessel, Qty. 1. Two are required per vessel cap	N3132008
DPC O-Ring for Digestion Vessel Caps with Pressure Control for High Pressure 100 mL (100 Bar) Digestion Vessel, Qty. 1. Two are required per vessel cap	N3133008
TFM Sample Vessel Insert for High Pressure 100 mL (100 Bar) Digestion Vessel	N3133009
Ceramic Pressure Jacket for High Pressure 100 mL (100 Bar) Digestion Vessel	N3133010
PEEK Ring Nut for High Pressure 100 mL (100 Bar) Digestion Vessel closure cap. (Left handed threads)	N3133011
PEEK Ring Nut Removal Tool	N3133021
Turntable Base Ring	N3134013



Gas Containment Manifold Spares

Description	Part No.
End Cap Plug for Gas Containment Manifold. Sealing Plug for 8 and 16-Position Gas Containment Manifold to seal the gas collection system at unused vessel positions	N3134004
Clamping Screw (PTFE) for the Top Seal of the 8 and 16-Position Gas Containment Manifold	N3134002
Lip Seal Ring of the Gas Containment Manifold. PTFE Sealing Ring for use with 8 and 16-Position Gas Containment Manifolds. Seals the top PFA gas tube to the Gas Containment Manifold	N3134000
Tube for Connection of Vessel to Gas Containment Manifold (PTFE). PTFE connecting tube for connection to digestion vessels with 8 and 16-Position Gas Containment Manifold	N3134005
Connector for Gas Containment Manifold to Digestion Vessel. PTFE connector for use with 8 and 16-Position Gas Containment Manifold	N3134007
Gas Containment Manifold PFA Vent Line 1 m	N3134014
Gas Containment Manifold Vent Line Replacement O-Ring (Qty. 2)	N3134072



Part No. **N3132000**

Consumable Run Kits

Description	Part No.
Run Kit for Standard 75 mL (40 Bar) Digestion Vessels Consumables for Approximately 2500 Digestions with Standard 75 mL (40 Bar) Digestion Vessels Includes: 10 Pressure Seals (N3132002), 4 Rupture Discs (N3132001), 5 Lip Seal Rings of the Gas Containment Manifold (N3134000)	N3132000
Run Kit for High Pressure 100 mL (100 Bar) Digestion Vessels Consumables for Approximately 2500 Digestions with High Pressure 100 mL (100 Bar) Digestion Vessels Includes: 10 Pressure Seals (N3133023); 7 Rupture Discs (N3133022), 50 PEEK Ring Nuts (N3133011) 5 Lip Seal Rings of the Gas Containment Manifold (N3134000)	N3133024

Education Services to Help Accelerate Your Science



Invest in Instrument Training

You are under tremendous pressure to meet tight budget constraints while performing more experiments than ever. Due to these dynamics, instrument training can seem like a luxury versus a necessity, and important benefits can be overlooked.

Choose the Option That's Right for You:

Classroom Training

Conducted by faculty at PerkinElmer Centers of Excellence

- Courses ranging from the basics to advanced techniques
- Hands-on experience in a laboratory environment
- Peer networking and collaboration
- Small class size to ensure individual attention
- 1-5 day options

Basic Training: Operation Essentials

Conducted by a certified Service Engineer in your lab

- For the beginner to intermediate user
- Courses adapted to meet your lab's needs
- System overview and basic principles
- Hands-on training using your instruments
 - Operational techniques
 - Instrument optimization/maintenance
 - Software operations/data acquisition
- 1-3 day options; up to four users per session

Advanced: Optimization Training and Applications

Conducted by a specialized Field Application Scientist in your lab

- For the experienced user
- Courses designed to address your unique challenges
- Customized hands-on training
 - In-depth instrument and software operations
 - Method optimization
 - Application-specific, consultative training
- 1-5 day options; up to four users per session

PerkinElmer Education Services enables you to:

- Keep your instrument running at peak performance with less downtime.
- Discover new instrument capabilities.
- Advance your knowledge base and skill set.
- Overcome the unique challenges of your application.

For more information including custom training options:

Email OnSiteTraining@PerkinElmer.com Visit www.perkinelmer.com/OneSourceTraining

PerkinElmer OneSource Service Contracts



Improve your instrument investment and avoid the high costs associated with instrument failure with a OneSource® service plan. Unexpected instrument failure not only disrupts laboratory productivity, but can be expensive to fix. Choosing a service contract that provides breakdown coverage can help protect you from unexpected costs.

Regular preventive maintenance will help optimize your instrumentation, increasing the efficiency of your laboratory and extending the lifetime of your instrument. Consider combining your scheduled preventive maintenance with instrument qualification in a single visit to help minimize disruption to your laboratory.

We offer the most robust compliance solution in the industry. With our suite of qualification services covering many technologies, from a classical paper-based solution to a metrology-based approach, we can help your laboratory produce accurate and compliant results, day after day, deliver consistent digestion results.

- Ensure against the cost of unexpected instrument failure.
- Ensure optimum instrument performance.
- Control service costs.
- End users produce accurate and reproducible results.

Choose the OneSource Plan That's Right for your Laboratory

Platinum

For laboratories where instrument uptime is critical to performance. Includes a proactive alert system, for enabled instruments, that triggers corrective actions to help avoid equipment downtime and unnecessary expenses.

Gold

Enhance laboratory productivity by maintaining instrument efficiency with priority response, remote technical support and regular preventive maintenance.

Bronze

An excellent and cost-effective way to extend all the benefits of a first year instrument warranty.

Features	Bronze Plan	Gold Plan	Platinum Plan
Response Time ¹	Priority over Billable	Priority Response	Highest Level Priority
PerkinElmer Certified Repair Parts ²	✓	✓	✓
Travel To Your Location ³	✓	✓	✓
Emergency Breakdown Visits	✓	✓	✓
Preventive Maintenance Visits	N/A	1 or 2 PM visits	1 or 2 PM visits
Technical And Remote Support	✓	✓	✓
Software Updates ⁴	✓	✓	✓
Radian™ Remote Monitoring ⁵	✓	✓	✓
OPTIONS			
Premium Qualification Solutions	N/A	optional	optional
24 Hour Response Time ⁶	N/A	N/A	optional
Training Discount ⁷	eligible for 5% discount	eligible for 10% discount	eligible for 15% discount
Upgrades Discount ⁸	eligible for 10% discount	eligible for 15% discount	eligible for 20% discount
Discount on New Purchase of Power Protection Unit ⁸	eligible for 10% discount	eligible for 15% discount	eligible for 20% discount
Consumables Discount ⁸	eligible for 5% discount	eligible for 10% discount	eligible for 15% discount

1. Priority response varies by region and is based on a 'best effort' basis. Please consult your local service engineers for additional information.

2. Excludes all consumables. Certain parts may also be excluded based on instrument type. Please contact your local service engineer for details.

3. Zone 1 travel is 100% included in all Service Plans. Travel outside Zone 1 may incur additional travel costs.

4. Software updates do not include software upgrades.

5. For Radian enabled instruments. Service Contract discount available on instruments monitored by Radian.

6. Only available to select Platinum Plan customers. Please consult your local service manager for availability and pricing.

7. Excludes training related to the following products: Informatics, diagnostics, all imaging instruments, automation and liquid handling, high content screening, radiometric detection, newborn screening, and microplate readers.

8. Discounts may not be available for all products or product lines. Please consult your local service engineers for additional information.

Visit www.perkinelmer.com/servicecontracts



PART NUMBER INDEX

Part No.	Page	Part No.	Page	Part No.	Page
00470258.....	94	09200271.....	24-26	09920379.....	76
00470988.....	21	09200272.....	24-25	09920483.....	24-25
00472014.....	21	09200273.....	24-26	09920515.....	48, 72
00472020.....	42	09200274.....	24-26	09920516.....	72
00472022.....	42, 55-56	09200275.....	21, 25	09920517.....	72
00473292.....	77	09200276.....	24, 25	09920518.....	48, 72
00473539.....	48, 52, 72	09200277.....	21, 25	09920545.....	48
00473543.....	48, 52, 72	09200278.....	25	09920546.....	48
00473550.....	96	09200341.....	25	09921003.....	47
00473552.....	96	09200342.....	25	09921028.....	57, 59
00473578.....	48	09200369.....	25	09921036.....	61
00570559.....	94	09200486.....	21, 27	09921045.....	48, 72
00570567.....	94	09200518.....	59, 63	09921057.....	61
00570948.....	21	09200593.....	51	09921061.....	59
00570984.....	21, 25, 27	09210011.....	74, 76, 78	09921062.....	59, 61
00572561.....	21	09210012.....	76, 78	09923037.....	96
00572615.....	21	09220410.....	59, 63	09923448.....	96
00572624.....	21	09902001.....	47	09923464.....	95
02506483.....	48	09902005.....	26	09923517.....	95
02506495.....	84-85	09902006.....	59	09923536.....	96
02506516.....	57, 76, 86	09902015.....	24-26, 59	09926068.....	24
02507987.....	21	09902033.....	47-48, 52, 72	09926070.....	59, 63
02508080.....	96	09902045.....	59	09926083.....	26
02509115.....	95	09902047.....	24	09926127.....	24-25
02900540.....	112	09902102.....	24, 26	09985708.....	26, 47-48, 72
02901518.....	17	09902123.....	83-84	09985723.....	72
03030106.....	94	09902131.....	59	09989859.....	61
03030133.....	27	09902143.....	61	09992731.....	61
03030135.....	27	09902147.....	21	09995097.....	95
03030204.....	94	09902151.....	47	09995098.....	95
03030264.....	94	09902155.....	59, 61	172-8805.....	34
03030284.....	94	09902207.....	57, 59, 63	180-7400.....	34
03030299.....	27	09902219.....	21	180-7401.....	34
03030349.....	94	09902223.....	58-59	180-7404.....	34
03030352.....	26-27	09902236.....	21	180-7444.....	34
03030353.....	26	09902239.....	26	190-6003.....	34
03030354.....	24, 26-27	09902240.....	21	206-50587.....	34
03030358.....	25	09902247.....	59	206-50588.....	34
03030402.....	26-27	09902473.....	26	206-50602.....	34
03030404.....	27	09903094.....	57, 86	206-50603.....	34
03030405.....	27	09903103.....	48	206-5887-02RI.....	34
03030433.....	26-27	09903104.....	48	45-0004-00.....	34
03030447.....	94	09903150.....	57	63-100011-00.....	34
03030448.....	94	09903199.....	48	63-100012-00.....	34
03030793.....	17	09903456.....	86	63-100012-EL.....	34
03030997.....	17	09903464.....	86	63-100013-00.....	34
03030998.....	17	09903465.....	86	63-100015-00.....	34
03031456.....	26	09903471.....	48	63-100016-00.....	34
03031460.....	24, 26	09903799.....	38	63-100017-00.....	34
03031573.....	20	09904845.....	95	63-100018-00.....	34
03031802.....	24, 26	09904846.....	95	63-100019-00.....	34
03031806.....	24, 26	09904991.....	51	63-100035-00.....	34
03031808.....	26	09905147.....	82	63-100036-00.....	34
03031810.....	24, 26	09907120.....	95	63-100037-00.....	34
03031812.....	24, 26	09907925.....	31	9423 393 95011.....	34
03031920.....	26	09908265.....	24, 26-27, 47-48, 55, 76	9423 393 95031.....	34
03033124.....	26	09908585.....	86, 96	9423 393 95041.....	34
09200064.....	61	09908587.....	76, 96	9423 393 95071.....	34
09200078.....	59	09919737.....	85	9423 393 95161.....	34
09200253.....	21	09920186.....	48	9423 490 20101.....	34

PART NUMBER INDEX

Part No.	Page	Part No.	Page	Part No.	Page
99-0059-00	34	B0193772	37	B0507921	36
99-0060-00	34	B0193873	36	B0507949	36
99-0061-00	34	B0194048	37	B0507957	37-38, 57
99-0342-00	34	B0194049	37	B0507959	37
B0017998	37	B0196704	36	B0507960	37
B0018283	37, 57, 101	B0196850	36, 57	B0507962	37
B0029792	37	B0196857	36, 57	B0508306	37, 57
B0029796	37	B0196882	36, 57	B0508310	37, 57, 96
B0046948	37	B0196963	100	B0508520	101
B0048139	37, 57, 101	B0196966	100	B0508594	38
B0066549	36	B0198005	31	B0508901	104
B0070126	37	B0198097	37-38, 57	B0509065	31
B0080259	33	B0198099	37	B0509095	38
B0087056	28	B0198100	37	B0509479	37
B0087354	39	B0198111	38	B0509554	101
B0087600	28	B0198201	36	B0509555	101
B0091504	32	B0199034	37, 96	B0509590	38
B0094032	39	B0199035	36	B0509612	37
B0094138	39	B0199233	36, 86	B0510032	37
B0094140	39	B0500748	31	B0510268	28
B0094321	39	B0501000	37	B0510334	36
B0094413	39	B0501022	25, 27	B0510370	36
B0094415	39	B0501025	25	B0510397	28
B0097693	39	B0501026	25	B0510398	28
B0097694	39	B0501044	100	B0810377	61
B0098452	39	B0501056	101	B0851900	31
B0098453	39	B0501236	31	B3000055	100
B0098640	39	B0501315	37	B3000132	101
B0101164	28	B0501580	36	B3000133	101
B0102332	28	B0501594	37	B3000135	101
B0104281	28	B0501595	37	B3000151	100
B0104344	28	B0501696	95	B3000152	100
B0105197	32	B0502706	95	B3000157	100
B0105973	28	B0504033	30	B3000158	100
B0105974	28	B0504035	31	B3000159	100
B0119079	28	B0504036	31	B3000160	100
B0121092	32	B0505057	32	B3000161	100
B0128495	33	B0505086	24-26	B3000240	38
B0129258	28	B0505480	27	B3000243	36
B0129303	28	B0505590	27	B3000251	38
B0132799	28	B0505650	38	B3000274	36
B0135653	32	B0506058	37, 96	B3000342	32
B0137111	32	B0506060	37	B3000350	39
B0148615	17	B0506666	25	B3000641	30
B0165332	25	B0506716	36	B3000653	30
B0172053	100	B0506722	31	B3000655	30
B0174378	25-26	B0506737	96	B3001254	32
B0187258	37	B0507020	37	B3001256	33
B0190634	33, 112	B0507021	37	B3001262	32
B0190635	33, 112	B0507226	112	B3001264	32
B0190672	25	B0507486	36	B3001485	28
B0191058	37-38, 57	B0507487	36	B3001505	28
B0191059	37-38, 57	B0507692	37, 96	B3001506	28
B0191060	37, 100	B0507708	25	B3001507	28
B0193160	37-38, 96	B0507791	38	B3001566	28
B0193161	37, 57, 96	B0507792	38	B3001567	28
B0193233	104	B0507914	38	B3001647	101
B0193234	104	B0507918	36, 57	B3001769	100
B0193235	104	B0507919	36, 101	B3001770	100
B0193342	36, 38, 57	B0507920	36	B3001771	100

PART NUMBER INDEX

Part No.	Page	Part No.	Page	Part No.	Page
B3001772	100	N0681688	52	N0770911	55
B3002006	28	N0690269	63	N0770916	59
B3002007	28	N0690271	51	N0770944	61
B3002046	28	N0690668	61	N0770965	57
B3002102	31	N0690670	47, 55	N0771116	61
B3002103	31	N0690672	61	N0771500	55, 57-58
B3120405	31	N0690676	47-48	N0771501	51, 55, 57
B3121301	33	N0690769	63	N0771526	63
B3130086	33	N0690772	61	N0771527	63
B3140236	101	N0691578	94	N0771529	101
B3140361	31	N0691579	114, 118	N0771531	55, 57, 62
B3140362	31	N0691580	118	N0771536	61
B3140617	101	N0691581	111, 118	N0771561	58
B3140618	101	N0691595	96	N0771650	89
B3140621	101	N0691678	61	N0771725	106
B3140622	101	N0691689	61	N0771726	106
B3140715	101	N0691743	118	N0772005	57-58
B3140721	96, 101	N0691745	111, 118	N0772006	57
B3140730	96, 101	N0691907	90	N0772008	58
B3140760	39	N0695362	55, 62	N0772017	50
B3141064	112	N0695426	57	N0773084	61
B3150169	17	N0695442	62	N0773090	61
B3150458	24	N0695449	62	N0773106	106
B3150462	24-25	N0695460	62	N0773111	96
B3150525	24-25, 27	N0695461	62	N0773112	96, 98
B3150531	24-25	N0695468	61	N0773113	86, 96
M8152475	80	N0695469	61	N0773115	96
MZ321146	91	N0695476	96	N0773116	96
MZ321147	91	N0695494	62	N0773117	96
N0370392	21, 27	N0695495	62, 76-77	N0773118	96
N0370393	27	N0770322	61	N0773119	96
N0370394	26-27	N0770336	47, 55, 57	N0773120	118, 121
N0370398	26	N0770338	55-56, 58	N0773197	43
N0370399	26	N0770343	58	N0774067	98
N0371485	26	N0770344	58	N0774068	98
N0371492	26	N0770357	52, 55-56	N0774069	69
N0371493	26	N0770358	47, 54-55, 57	N0774070	57, 60
N0371505	26, 47	N0770389	51, 57	N0774077	43, 69
N0371520	26, 27	N0770420	57	N0774080	43, 69
N0371522	26, 27	N0770437	59	N0774085	101
N0400058	21, 27	N0770438	63	N0774088	101
N0400100	20	N0770546	47, 55-56	N0774095	104
N0400101	20	N0770600	51, 55	N0774096	104
N0400102	20	N0770603	63	N0774101	51
N0400103	20	N0770605	55	N0775014	62
N0401171	21	N0770606	55	N0775177	55-56, 62
N0580531	95	N0770607	55	N0775220	95
N0581497	61	N0770609	51, 55	N0775223	62
N0582152	118	N0770610	47, 55	N0775224	62
N0582184	62	N0770613	51	N0775225	62
N0582185	62	N0770614	51, 57	N0775226	62
N0582186	62	N0770689	57	N0775227	62
N0582251	95	N0770720	47	N0775228	62
N0680275	61	N0770730	56	N0775247	62
N0680375	57	N0770731	56	N0775289	56-58
N0680504	47, 55, 69, 74	N0770732	57	N0775297	56-58
N0680612	72	N0770755	53	N0775300	61
N0681470	118	N0770756	53	N0775325	95
N0681574	42, 68	N0770757	53	N0775330	44
N0681631	77	N0770910	55	N0775331	49

Part No.	Page	Part No.	Page	Part No.	Page
N0775340	69	N0777044	62	N0777236	103
N0775341	69	N0777049	45	N0777237	103
N0775342	69, 86	N0777051	60	N0777238	103
N0775343	69	N0777052	60	N0777239	103
N0775344	69	N0777053	60	N0777242	103
N0775345	43	N0777054	60	N0777243	103
N0775346	43	N0777055	60, 79	N0777244	103
N0775347	43	N0777061	43, 69, 98	N0777245	103
N0775348	43	N0777062	101	N0777247	103
N0775349	43	N0777063	126	N0777248	103
N0775350	73	N0777064	126	N0777249	103
N0775351	50	N0777095	90, 95	N0777250	103
N0775352	51, 86	N0777099	104	N0777251	103
N0775355	51	N0777110	96	N0777252	103
N0775356	51	N0777111	44	N0777253	103
N0775358	49, 72	N0777112	44	N0777258	105
N0776006	51	N0777113	44	N0777283	81, 99
N0776007	51	N0777114	44	N0777284	99
N0776014	57, 63	N0777115	44	N0777285	102
N0776025	57	N0777116	44	N0777286	102
N0776027	58	N0777117	44	N0777287	68
N0776028	58	N0777148	101	N0777288	68
N0776052	50, 56	N0777149	101	N0777289	81
N0776053	51	N0777150	101	N0777294	70
N0776090	51, 57	N0777151	101	N0777295	70
N0776091	57, 63	N0777152	101	N0777297	81, 99
N0776093	57, 62	N0777153	101	N0777298	101
N0776103	126	N0777154	101	N0777319	89
N0776104	125	N0777155	101	N0777328	95
N0776105	125	N0777156	104	N0777342	89
N0776106	125	N0777159	104	N0777354	53
N0776107	125	N0777167	104	N0777355	53
N0776108	126	N0777168	104	N0777356	53
N0776109	125	N0777174	89	N0777357	53
N0776115	104	N0777175	89	N0777359	95
N0776116	104	N0777176	89	N0777360	95
N0776117	104	N0777177	89	N0777366	76
N0776118	104	N0777196	89	N0777368	101
N0776130	125	N0777214	46, 71, 102	N0777373	62
N0776131	125	N0777215	46, 71, 102	N0777374	62
N0776132	125	N0777216	46, 71, 102	N0777375	45, 70
N0776133	125	N0777217	46, 71, 102	N0777376	45, 70
N0776134	125	N0777218	46, 71, 102	N0777392	105
N0776135	125	N0777219	45	N0777393	105
N0776136	125	N0777220	70	N0777396	105
N0776137	125	N0777221	102, 129	N0777397	103
N0776138	125	N0777222	102	N0777398	103
N0776139	125	N0777223	46, 71, 102	N0777402	105
N0776140	125	N0777224	102	N0777403	105
N0776141	125	N0777225	46, 71, 102	N0777404	105
N0776142	125	N0777226	102	N0777405	105
N0776143	125	N0777227	102	N0777406	105
N0776200	90	N0777228	103	N0777407	105
N0777031	44	N0777229	103	N0777410	77
N0777032	44	N0777230	103	N0777413	43, 44
N0777034	74	N0777231	103	N0777414	42
N0777035	74	N0777232	103	N0777415	79
N0777036	50	N0777233	103	N0777416	79
N0777042	85, 96	N0777234	103	N0777417	79
N0777043	96	N0777235	103	N0777419	79

PART NUMBER INDEX

Part No.	Page	Part No.	Page	Part No.	Page
N0777420	79	N0777610	64	N0777729	93
N0777430	81	N0777611	64	N0777731	51, 57
N0777434	71	N0777612	64, 65	N0777734	44
N0777435	43, 69	N0777613	93	N0777735	44
N0777436	43, 69	N0777618	65	N0777736	44
N0777437	43, 69	N0777630	62	N0777737	44
N0777438	51, 74	N0777631	62	N0777738	44
N0777439	51, 74	N0777632	62	N0777743	65
N0777441	96	N0777633	62	N0777744	65
N0777442	96	N0777634	62	N0777769	68
N0777443	96	N0777635	50	N0777771	103
N0777444	85, 96	N0777637	50	N0777772	103
N0777445	96	N0777638	50	N0777777	81
N0777446	96	N0777639	103	N0777783	106
N0777447	96	N0777640	103	N0777784	106
N0777457	77	N0777641	103	N0777785	106
N0777460	42, 68	N0777642	103	N0777788	106
N0777461	98	N0777643	103	N0777798	93
N0777462	43, 69, 98	N0777644	103	N0777813	105
N0777463	43, 69, 98	N0777658	68	N0777814	105
N0777464	43, 69, 98	N0777659	68	N0777815	105
N0777465	98	N0777660	68	N0777818	105
N0777466	98	N0777661	68	N0777819	105
N0777476	96	N0777664	81	N0777820	105
N0777479	81	N0777665	81	N0777821	105
N0777480	81	N0777666	81	N0777822	103
N0777484	69	N0777667	81	N0777823	103
N0777485	69	N0777676	45	N0777824	53
N0777486	69	N0777681	93	N0777826	46, 71, 102
N0777487	44	N0777682	93	N0777827	46, 71, 102
N0777488	44	N0777687	89	N0777828	45, 70
N0777489	44	N0777689	93	N0777829	99
N0777494	50	N0777690	92	N0777830	99
N0777495	50	N0777691	104	N0777836	53
N0777496	52	N0777692	104	N0777840	60
N0777497	52, 55	N0777693	104	N0777841	60
N0777508	60	N0777694	104	N0777842	60
N0777509	60	N0777695	104	N0777843	60
N0777510	60	N0777696	104	N0777844	51-52
N0777511	93	N0777697	104	N0777845	43, 69
N0777512	43, 44, 69	N0777698	104	N0777846	43, 69
N0777513	43, 69	N0777699	104	N0777847	43, 69
N0777514	43, 69	N0777700	104	N0777848	98
N0777518	96	N0777701	104	N0777870	29
N0777521	96	N0777702	104	N0777871	29
N0777522	102	N0777703	104	N0777874	96
N0777523	102	N0777704	104	N0777880	60
N0777547	101	N0777705	104	N0777881	64
N0777561	96	N0777706	104	N0777882	64
N0777565	101	N0777707	42, 54-56	N0777883	64
N0777568	101	N0777710	95	N0777900	106, 135
N0777599	104	N0777711	96	N0777901	104
N0777602	64	N0777712	49, 72	N0777920	91
N0777603	64	N0777713	44	N0777930	106
N0777604	64	N0777714	44	N0777940	104
N0777605	64	N0777715	60	N0777941	104
N0777606	64	N0777717	101	N0777942	104
N0777607	64	N0777719	93	N0780128	58-59
N0777608	64	N0777727	93	N0780130	55-56, 58
N0777609	64	N0777728	93	N0780132	57-58
				N0780133	58

PART NUMBER INDEX

Part No.	Page	Part No.	Page	Part No.	Page
N0780437	59	N0790373	52	N0810861	60
N0780546	47, 54-56	N0790384	52, 56	N0810862	65
N0780606	55	N0790412	57	N0810863	65
N0780607	55	N0790437	59, 63	N0810870	65
N0780608	57	N0790439	61	N0810871	65
N0780616	56	N0790440	59, 63	N0811287	42
N0780617	56	N0790441	59, 63	N0811288	42
N0780676	47	N0790442	60	N0811289	43
N0780759	53	N0790606	54	N0811291	43
N0780760	53	N0790607	54	N0811292	43
N0780761	53	N0790608	56	N0811293	43
N0780825	89	N0790609	56	N0811294	43
N0780826	89	N0790610	57	N0811298	43
N0781007	57, 62	N0790611	54	N0811299	43
N0781008	62	N0790953	53	N0811300	43
N0781009	62	N0790959	53	N0811301	43
N0781013	62	N0790960	65	N0811302	43
N0781014	55-56, 62	N0790964	65	N0811303	43
N0781015	62	N0790965	65	N0811305	43
N0781016	62	N0791125	58	N0811306	43
N0781017	62	N0791163	63	N0811307	43
N0781018	62	N0791180	62	N0811308	43
N0781019	62	N0791181	62	N0811900	51
N0781050	62	N0791182	54, 57, 62	N0811901	51
N0781097	56, 58	N0791183	54, 56, 62-63	N0811902	59
N0781598	49	N0791184	62	N0811903	59
N0782004	62	N0791185	62	N0811904	60
N0782005	62	N0791186	62	N0811906	59
N0782006	62	N0791187	62	N0811907	59
N0782007	62	N0791188	62	N0811908	58
N0782008	62	N0791189	62	N0811912	60
N0782009	62	N0791190	62	N1010215	26
N0782010	62	N0791300	60	N2010245	27
N0782012	50	N0791301	60	N2010246	25, 27
N0782014	50	N0791303	60	N2010247	26-27
N0782019	103	N0791333	59, 63	N2010250	25, 27
N0782035	89	N0791334	58, 59	N2010255	38
N0782036	89	N0791352	51, 54, 56-57	N2010262	38
N0782060	106	N0791438	42, 51, 57	N2011074	21
N0786010	89	N0791499	54	N2020005	89
N0786011	89	N0791841	51	N2020006	89
N0786019	53	N0791842	51	N2020007	89
N0786020	53	N0791843	42	N2024131	71
N0786021	62	N0791847	52	N2024132	71
N0786022	62	N0791848	52	N2024191	81
N0786030	99	N0791849	62	N2025300	19
N0786036	99	N0791850	62	N2025301	19
N0786043	71	N0791851	62	N2025302	19
N0790131	54, 56, 58	N0810128	54, 58	N2025303	19
N0790138	54, 58	N0810194	61	N2025304	19
N0790141	54, 56-57, 63	N0810214	58	N2025305	19
N0790143	63	N0810346	61	N2025306	19
N0790154	63	N0810439	61	N2025307	19
N0790156	56, 63	N0810606	54	N2025308	19
N0790188	94	N0810607	54	N2025309	19
N0790189	94	N0810609	54	N2025310	19
N0790196	61	N0810856	53	N2025311	19
N0790214	58	N0810857	53	N2025312	19
N0790249	54, 57-58	N0810858	53	N2025313	19
N0790296	52, 56	N0810860	53	N2025314	19

PART NUMBER INDEX

Part No.	Page	Part No.	Page	Part No.	Page
N2025315	19	N3050114	14	N3050206	15
N2025316	19	N3050115	14	N3050208	15
N2025317	19	N3050118	14	N3050209	15
N2025318	19	N3050119	14	N3050212	15
N2025319	19	N3050121	14	N3050213	15
N2025320	19	N3050122	14	N3050214	15
N2025321	19	N3050123	14	N3050217	15
N2025322	19	N3050124	14	N3050218	15
N2025323	19	N3050126	14	N3050302	15
N2025324	19	N3050128	14	N3050303	14
N2025325	19	N3050129	14	N3050305	14
N2025326	19	N3050130	14	N3050309	14
N2025327	19	N3050133	14	N3050314	14
N2025328	19	N3050134	14	N3050315	14
N2025329	19	N3050135	14	N3050319	14
N2025330	19	N3050137	14	N3050321	14
N2025331	19	N3050138	14	N3050326	14
N2025332	19	N3050139	14	N3050339	14
N2025333	19	N3050141	14	N3050344	14
N2025334	19	N3050142	14	N3050345	14
N2025335	19	N3050144	14	N3050348	15
N2025336	19	N3050145	14	N3050352	14
N2025337	19	N3050146	14	N3050357	14
N2025338	19	N3050148	15	N3050365	14
N2025339	19	N3050149	14	N3050370	14
N2025340	19	N3050150	14	N3050391	15
N2025341	19	N3050152	14	N3050605	17
N2025342	19	N3050155	14	N3050611	17
N2025343	19	N3050157	14	N3050615	17
N2025344	19	N3050158	14	N3050620	17
N2025345	19	N3050161	14	N3050630	17
N2025346	19	N3050162	14	N3050634	17
N2025347	19	N3050165	14	N3050655	17
N2025348	19	N3050166	14	N3050657	17
N2025349	19	N3050168	14	N3050664	17
N2025350	19	N3050170	14	N3050670	17
N2025351	19	N3050171	15	N3050672	17
N2025352	19	N3050172	15	N3050675	17
N2025353	19	N3050173	15	N3050680	17
N2025354	19	N3050174	14	N3050683	17
N2025355	19	N3050175	15	N3050691	17
N2025356	19	N3050176	15	N3050860	17
N2025357	19	N3050177	15	N3050861	17
N2025358	19	N3050178	15	N3050862	17
N2025359	19	N3050180	15	N3050863	17
N2025360	19	N3050182	15	N3050864	17
N2025361	19	N3050183	15	N3050865	17
N2025362	19	N3050184	15	N3050866	17
N2025363	19	N3050186	15	N3050867	17
N2025364	19	N3050187	15	N3050868	17
N2025365	19	N3050189	15	N3050869	17
N2025366	19	N3050190	15	N3050870	17
N3050102	15	N3050191	15	N3050871	17
N3050103	14	N3050192	15	N3050872	17
N3050105	14	N3050197	17	N3050873	17
N3050107	14	N3050201	15	N3050874	17
N3050108	14	N3050202	15	N3051050	17
N3050109	14	N3050203	15	N3110147	30
N3050110	14	N3050204	15	N3130100	135
N3050111	14	N3050205	15	N3130110	135

PART NUMBER INDEX

Part No.	Page	Part No.	Page	Part No.	Page
N3131005	136	N3150525	27	N8121045	69
N3131006	136	N3151205	24-25	N8121046	69
N3131007	136	N3160133	24	N8121056	69
N3131008	136	N3160143	27	N8121057	69
N3131009	135	N3160144	27	N8121061	69
N3131010	136	N3160146	25, 27	N8121068	91
N3131011	136	N3160152	27	N8121069	91, 106
N3132000	137	N3160153	24, 27	N8121086	83
N3132001	137	N3160154	24, 27	N8122004	82
N3132002	137	N3160156	27	N8122006	76, 79, 85-86
N3132003	137	N3160157	27	N8122007	78
N3132004	137	N3160158	27	N8122010	78
N3132005	137	N3160159	27	N8122012	76, 96
N3132006	137	N3160188	21, 27	N8122014	118
N3132007	137	N3160189	21, 27	N8122017	118
N3132008	137	N3160192	27	N8122038	118, 121
N3132009	136	N3160193	27	N8122188	73
N3132010	136	N3160194	27	N8122192	70, 76
N3132011	136	N3160231	17	N8122239	48, 72
N3132012	136	N3160505	21, 27	N8122308	82
N3132013	136	N3160506	21	N8122350	46, 71
N3132014	136	N3160511	21, 27	N8122351	46, 71, 76
N3132015	136	N3160545	21	N8122356	74
N3133003	137	N3160683	21, 27	N8122357	76
N3133006	137	N3160809	21	N8122358	78
N3133007	137	N3160811	17	N8122359	78
N3133008	137	N3161006	24	N8122382	45, 70
N3133009	137	N3161057	24	N8122383	45, 70
N3133010	137	N3161224	21	N8122384	45, 70
N3133011	137	N3161240	20	N8122389	76
N3133012	136	N3180626	17	N8122394	78
N3133013	136	N5316000	127	N8122410	76
N3133014	136	N5316001	127	N8122411	76-78
N3133015	136	N5316002	127	N8122412	76-78
N3133016	136	N5316003	127	N8122413	77-78
N3133017	136	N5316004	127	N8122452	76
N3133018	136	N5316005	127	N8122460	42, 68
N3133019	136	N5316024	127	N8122461	42, 68
N3133021	137	N5316025	127	N8122462	42, 68
N3133022	137	N8102011	68	N8122463	103
N3133023	137	N0810433	57	N8122464	103
N3133024	137	N8120100	78	N8125001	82
N3134000	137	N8120116	78	N8125010	118
N3134002	137	N8120124	74	N8125029	77, 86
N3134004	137	N8120511	83, 86	N8125030	118
N3134005	137	N8120512	83, 86	N8125031	118
N3134007	137	N8120515	72, 86	N8125032	118
N3134009	136	N8120516	72, 76	N8125033	118, 121
N3134010	136	N8120518	86	N8125034	118
N3134011	136	N8120519	86	N8125035	118
N3134012	136	N8120522	118	N8125037	118, 120
N3134013	137	N8120541	118	N8125038	118, 120
N3134014	137	N8120610	86	N8125039	120
N3134015	135	N8120611	86	N8125040	118
N3134072	137	N8121035	49, 72	N8125041	118
N3134094	136	N8121036	42, 68	N8125050	82
N3150131	17	N8121037	42, 68	N8126041	86
N3150188	27	N8121038	42, 68	N8126045	57
N3150230	21	N8121039	42, 68	N8140032	129
N3150303	17	N8121043	105	N8140360	78

PART NUMBER INDEX

Part No.	Page	Part No.	Page	Part No.	Page
N8140503	120	N8145109	77	N8145174	97
N8140504	120	N8145110	77	N8145175	97
N8140507	76	N8145111	77	N8145176	97
N8140511	76	N8145112	77	N8145177	97
N8140513	85	N8145113	77	N8145178	97
N8140527	78	N8145114	77	N8145179	97
N8140747	76	N8145115	77	N8145180	97
N8140748	76	N8145116	77	N8145181	97
N8140749	76	N8145117	77	N8145182	97
N8141230	106	N8145118	77	N8145183	97
N8141315	79	N8145119	74	N8145184	97
N8141420	74	N8145120	74	N8145185	97
N8141425	76	N8145121	74	N8145186	97
N8142000	74	N8145122	74	N8145187	97
N8142001	76	N8145125	105	N8145188	97
N8142002	76	N8145129	103	N8145189	97
N8142003	75	N8145130	103	N8145190	97
N8142011	106	N8145131	103	N8145191	97
N8142012	106	N8145132	105	N8145192	97
N8142045	129	N8145133	105	N8145193	97
N8142046	129	N8145134	105	N8145194	97
N8142047	129	N8145135	45, 70	N8145195	97, 129
N8145000	82	N8145136	45, 70	N8145196	97
N8145003	82	N8145137	45, 70	N8145197	97
N8145011	68	N8145138	45, 70	N8145198	97
N8145012	68	N8145139	46, 71	N8145199	97
N8145013	73, 85	N8145140	46, 71	N8145200	97
N8145014	73, 85	N8145141	46, 71, 102	N8145201	97
N8145015	68, 85	N8145142	46, 71, 102	N8145202	97
N8145016	68, 85	N8145143	46, 71, 102	N8145203	97
N8145017	68, 71, 85, 99, 129	N8145144	46, 71, 102	N8145204	97
N8145018	68, 71, 81, 85, 99, 129	N8145145	97	N8145205	97
N8145027	82	N8145146	97	N8145206	97
N8145028	83	N8145147	97	N8145207	97
N8145049	120	N8145148	97	N8145208	97
N8145050	120-121	N8145149	97	N8145209	97
N8145051	118, 120	N8145150	84, 97	N8145210	97
N8145052	120	N8145151	97	N8145211	97
N8145053	120	N8145152	97	N8145212	97
N8145054	120	N8145153	97	N8145213	97
N8145055	120	N8145154	97	N8145214	97
N8145056	120	N8145155	97	N8145215	97
N8145057	120	N8145156	97	N8145216	97
N8145058	120	N8145157	97	N8145217	97
N8145059	120	N8145158	97	N8145218	97
N8145060	121	N8145159	97	N8145219	97
N8145061	121	N8145160	97	N8145220	97
N8145072	77	N8145161	97	N8145236	49, 72
N8145074	87	N8145162	97	N8145237	99
N8145075	87	N8145163	97	N8145238	99
N8145079	105	N8145164	97	N8145275	46, 71, 102
N8145099	75	N8145165	97	N8145280	87
N8145101	70	N8145166	97	N8145281	87
N8145102	46, 71	N8145167	97	N8145284	118, 120
N8145103	46, 71	N8145168	97	N8145289	120
N8145104	46, 71	N8145169	97	N8145309	75
N8145105	105	N8145170	97	N8145310	75
N8145106	79	N8145171	97	N8145314	75
N8145107	77	N8145172	97	N8145315	49, 72
N8145108	77	N8145173	84, 97	N8145316	49, 72

PART NUMBER INDEX

Part No.	Page	Part No.	Page	Part No.	Page
N8145317	103	N8150035	80	N8151066	112
N8145318	79	N8150036	81	N8151067	112
N8145319	83	N8150037	81	N8151068	112
N8145320	83	N8150038	80	N8151069	112
N8145321	74	N8150040	80	N8151070	69
N8145329	89	N8150054	84	N8151071	69
N8145338	77	N8150055	84	N8151072	69
N8145339	77	N8150056	84	N8151073	69
N8145340	75	N8150057	84	N8151074	69
N8145344	102	N8150058	84	N8151075	69
N8145345	68	N8150060	80-81	N8151076	69
N8145346	42, 68	N8150279	78	N8151077	69
N8145347	42, 68	N8150321	129	N8151078	69
N8145348	105	N8150390	87, 89	N8151079	69
N8145349	105	N8150391	87, 89	N8151093	112
N8145350	105	N8150427	72	N8151094	112
N8145351	105	N8150428	72	N8151095	112
N8145352	105	N8150429	72	N8151096	112
N8145353	105	N8150445	75	N8151097	112
N8145354	103	N8150446	75	N8151098	112
N8145358	48	N8150450	74, 80	N8152136	84, 95
N8145359	48	N8150468	87	N8152167	84, 95
N8145360	48	N8150469	87	N8152359	81
N8145361	48	N8150478	87	N8152364	81
N8145362	48	N8150479	87	N8152372	68, 80
N8145363	48	N8150743	72	N8152373	68, 80
N8145364	48	N8151032	121	N8152374	74, 80-81
N8145365	42, 48	N8151033	120	N8152375	73, 80, 84
N8145368	45, 70	N8151034	123	N8152376	77, 81, 84
N8145400	89	N8151035	123	N8152377	80-81, 129
N8145407	91	N8151036	123	N8152378	80-81
N8145419	120	N8151037	121	N8152379	79-81, 84
N8145420	120	N8151038	121	N8152380	81
N8145421	120	N8151039	112	N8152382	75, 80-81
N8145422	120	N8151040	112	N8152383	73, 80
N8145446	75	N8151041	112	N8152384	68
N8145457	49	N8151042	112	N8152385	68
N8145461	42, 68	N8151043	112	N8152386	68, 80, 99
N8145462	42, 68	N8151044	112	N8152387	68, 99
N8145463	42	N8151045	112	N8152388	68, 84, 99
N8145464	42	N8151046	112	N8152389	73, 80-81, 84
N8145465	42	N8151047	112	N8152390	74
N8145466	42	N8151048	112	N8152401	97, 129
N8145473	105	N8151049	112	N8152402	97
N8145474	105	N8151050	112	N8152403	97
N8145475	105	N8151051	112	N8152404	97
N8145476	105	N8151052	112	N8152405	84, 97
N8145503	68, 80, 84	N8151053	112	N8152406	97
N8145504	102	N8151054	112	N8152407	97
N8145508	129	N8151055	112	N8152408	97
N8145516	74	N8151056	112	N8152409	97
N8145517	74	N8151057	112	N8152410	97
N8145518	74	N8151058	112	N8152411	97
N8145520	99	N8151059	112	N8152412	97
N8145531	70	N8151060	112	N8152413	97
N8145536	81	N8151061	112	N8152414	97
N8150031	80	N8151062	112	N8152415	84, 97
N8150032	129	N8151063	112	N8152420	71, 80, 102
N8150033	80	N8151064	112	N8152421	99
N8150034	80	N8151065	112	N8152422	99

PART NUMBER INDEX

Part No.	Page	Part No.	Page	Part No.	Page
N8152423	80-81, 99	N8152591	71, 102	N9300144	109
N8152424	73, 81, 84	N8152592	71, 102	N9300145	109
N8152425	73, 80-81	N8152593	71, 102	N9300146	109
N8152426	74, 80	N8152594	71, 102	N9300147	109
N8152427	79	N8152595	71, 102	N9300148	109, 116
N8152428	79, 81, 84, 129	N8152596	79	N9300149	109
N8152429	77, 80	N8152603	77	N9300150	109
N8152430	80-81	N8152604	77	N9300151	109
N8152431	80-81	N8152606	77	N9300152	109, 116
N8152432	81, 129	N8152616	80	N9300153	109, 116
N8152433	81	N8152683	72	N9300154	109
N8152434	80-81	N8152692	72	N9300155	109
N8152435	80-81	N8152720	74	N9300157	109
N8152437	81	N9300065	26	N9300158	109
N8152438	81	N9300067	47	N9300160	109
N8152439	81	N9300068	94	N9300161	109, 116
N8152440	81	N9300100	109, 116	N9300162	109, 116
N8152441	81	N9300101	109, 116	N9300163	109
N8152442	81	N9300102	109	N9300165	109, 116
N8152443	77, 79-81	N9300103	109	N9300166	109
N8152444	77	N9300104	109	N9300167	109, 116
N8152445	77	N9300105	109	N9300168	109
N8152446	77	N9300106	109	N9300169	109
N8152447	77, 80	N9300107	109	N9300170	109
N8152448	80	N9300108	109, 116	N9300171	109
N8152449	74, 80	N9300109	109	N9300172	109
N8152451	77, 79-81, 84, 129	N9300110	109	N9300173	109
N8152452	80-81, 102	N9300111	109	N9300174	109
N8152453	68, 80, 84, 99	N9300112	109, 116	N9300175	109
N8152455	70, 80-81, 84	N9300113	109	N9300176	109
N8152456	74, 80-81, 84	N9300114	109, 116	N9300177	109
N8152465	84, 95	N9300115	109	N9300178	109
N8152472	79-80, 84	N9300116	109	N9300179	109, 116
N8152473	79-80, 84	N9300117	109	N9300180	109
N8152474	73, 79-81	N9300118	109	N9300181	109
N8152476	77, 79	N9300119	109	N9300182	109
N8152478	70	N9300120	109	N9300183	109
N8152479	70	N9300121	109	N9300184	109, 116
N8152480	70	N9300122	109	N9300200	114, 117
N8152489	129	N9300123	109	N9300201	114, 117
N8152493	73, 129	N9300124	109	N9300202	114, 117
N8152494	129	N9300125	109	N9300203	114, 117
N8152495	129	N9300126	109, 116	N9300204	114, 117
N8152496	129	N9300127	109	N9300205	117, 119
N8152497	129	N9300128	109	N9300207	109, 117, 119
N8152532	80-81	N9300129	109, 116	N9300208	117, 119
N8152533	80-81	N9300130	109	N9300211	117
N8152535	81	N9300131	109, 116	N9300212	117
N8152536	81	N9300132	109, 116	N9300213	117
N8152551	74, 80	N9300133	109	N9300214	117
N8152571	99	N9300134	109	N9300215	117
N8152582	71	N9300135	109	N9300216	117
N8152583	71	N9300136	109, 116	N9300217	117
N8152584	71	N9300137	109	N9300218	116, 119
N8152585	71	N9300138	109	N9300219	116, 119
N8152586	71	N9300139	109	N9300220	116, 119
N8152587	71, 102	N9300140	109	N9300221	116, 118-119
N8152588	71, 102	N9300141	109, 116	N9300223	117
N8152589	71, 102	N9300142	109	N9300224	119
N8152590	71, 102	N9300143	109	N9300225	120

PART NUMBER INDEX

Part No.	Page	Part No.	Page	Part No.	Page
N9300226	116, 119	N9303736	109	N9303796	109
N9300227	116, 119	N9303737	109	N9303797	119
N9300228	116, 119	N9303738	109	N9303798	109
N9300229	116, 119	N9303739	111	N9303799	109
N9300230	114	N9303740	109	N9303800	109
N9300231	113	N9303741	111	N9303801	109
N9300232	113	N9303742	109	N9303802	109
N9300233	113	N9303743	109	N9303803	109
N9300234	113	N9303744	109	N9303804	109
N9300235	113, 116	N9303745	109	N9303806	109
N9300236	113	N9303746	109	N9303807	109
N9300238	113, 121	N9303747	109	N9303808	109
N9300239	113	N9303748	109	N9303809	109
N9300241	117	N9303749	111	N9303810	109
N9300244	112	N9303750	109	N9303811	109
N9300253	115	N9303751	111	N9303812	109
N9300260	112	N9303752	109	N9303813	121
N9300280	114	N9303753	111	N9303814	113, 121
N9300281	114	N9303754	109	N9303816	115, 118, 121
N9300283	111	N9303755	109	N9303818	118
N9300651	32	N9303756	109	N9303819	115
N9300800	131	N9303757	111	N9303821	115, 119
N9300801	131	N9303758	109	N9303822	115, 119
N9300802	131	N9303759	109	N9303823	115, 119
N9300803	131	N9303760	109	N9303824	115, 119
N9300804	131	N9303761	109	N9303825	118
N9300805	131	N9303762	109	N9303826	118
N9300806	131	N9303763	109	N9303827	115
N9300807	131	N9303764	111	N9303828	119
N9300808	131	N9303765	109	N9303829	115
N9300809	131	N9303766	109	N9303830	119
N9300810	132	N9303767	109	N9303831	119
N9300811	134	N9303768	109	N9303832	120
N9300850	127	N9303769	109	N9303833	120
N9301205	104	N9303770	109	N9303834	120
N9301398	95	N9303771	109	N9303835	116
N9301399	95	N9303772	109	N9303836	116
N9301710	95	N9303773	109	N9303837	114
N9301711	95	N9303774	109	N9303838	109
N9301712	95	N9303775	109	N9303839	114, 116
N9301714	95	N9303776	109	N9303840	114, 116
N9301715	95	N9303777	109	N9303841	114
N9301720	113	N9303778	109	N9303842	109
N9301721	115, 118	N9303779	109	N9303843	115, 118
N9301722	120	N9303780	109	N9303844	109
N9302197	95	N9303781	109	N9303940	113
N9302199	95	N9303782	109	N9303941	113
N9302946	118	N9303783	109	N9303942	113
N9303445	33, 112	N9303784	109	N9303943	113
N9303725	109	N9303785	109	N9303944	113
N9303726	109	N9303786	109	N9303945	113
N9303727	109	N9303787	109	N9303946	113
N9303728	122-123	N9303788	109	N9303948	114
N9303729	109	N9303789	109	N9303949	113
N9303730	109	N9303790	109	N9303952	117
N9303731	109, 111	N9303791	109	N9303953	119
N9303732	121	N9303792	109	N9303954	113
N9303733	109	N9303793	109	N9303955	121
N9303734	109	N9303794	109	N9304110	111
N9303735	109	N9303795	109	N9304111	111

PART NUMBER INDEX

Part No.	Page	Part No.	Page	Part No.	Page
N9304112	111	N9304239	110	N9304299	111
N9304113	111	N9304240	110	N9304300	111
N9304114	111	N9304241	110	N9304301	111
N9304115	111	N9304242	110	N9304302	111
N9304116	111	N9304243	110	N9304303	111
N9304117	111	N9304244	110	N9304304	111
N9304118	111	N9304245	110	N9304305	111
N9304119	111	N9304246	110	N9304306	111
N9304120	111	N9304247	110	N9304307	111
N9304121	111	N9304248	110	N9304308	111
N9304122	111	N9304249	110	N9304309	111
N9304123	111	N9304250	110	N9304310	111
N9304124	111	N9304251	110	N9304311	111
N9304125	111	N9304252	110	N9304312	111
N9304126	111	N9304253	110	N9304313	111
N9304127	111	N9304254	110	N9304314	111
N9304128	111	N9304255	110	N9304315	111
N9304129	111	N9304256	110	N9304316	111
N9304130	114	N9304257	110	N9304317	111
N9304131	114	N9304258	110	N9304318	111
N9304168	125	N9304259	110	N9304319	111
N9304200	110	N9304260	110	N9304320	111
N9304201	110	N9304261	110	N9304321	111
N9304202	110	N9304262	110	N9304322	111
N9304203	110	N9304263	110	N9304323	111
N9304204	110	N9304264	110	N9304324	111
N9304205	110	N9304265	110	N9304325	111
N9304206	110	N9304266	110	N9304326	111
N9304207	110	N9304267	110	N9304327	111
N9304208	110	N9304268	110	N9304328	111
N9304209	110	N9304269	110	N9304329	111
N9304210	110	N9304270	110	N9304330	111
N9304211	110	N9304271	110	N9304331	111
N9304212	110	N9304272	110	N9304332	111
N9304213	110	N9304273	110	N9304333	111
N9304214	110	N9304274	110	N9304334	111
N9304215	110	N9304275	110	N9304335	111
N9304216	110	N9304276	110	N9304336	111
N9304217	110	N9304277	110	N9304337	111
N9304218	110	N9304278	110	N9304338	111
N9304219	110	N9304279	110	N9304339	111
N9304220	110	N9304280	110	N9304340	111
N9304221	110	N9304281	110	N9304341	111
N9304222	110	N9304282	110	N9304342	111
N9304223	110	N9304283	110	N9304343	111
N9304224	110	N9304284	110	N9304344	111
N9304225	110	N9304285	110	N9304345	111
N9304226	110	N9304286	110	N9304346	111
N9304227	110	N9304287	110	N9304347	111
N9304228	110	N9304288	110	N9304348	111
N9304229	110	N9304289	110	N9304349	111
N9304230	110	N9304290	110	N9304350	111
N9304231	110	N9304291	110	N9304351	111
N9304232	110	N9304292	111	N9304352	111
N9304233	110	N9304293	111	N9304353	111
N9304234	110	N9304294	111	N9304354	111
N9304235	110	N9304295	111	N9304355	111
N9304236	110	N9304296	111	N9304356	111
N9304237	110	N9304297	111	N9304357	111
N9304238	110	N9304298	111	N9304358	111

Part No.	Page	Part No.	Page	Part No.	Page
N9304359	111	N9304646	32	N9308003	133
N9304360	111	N9304647	32	N9308008	133
N9304361	122	N9304648	30	N9308009	132
N9304362	122	N9306016	38	N9308011	132
N9304363	122	N9306067	95	N9308013	132
N9304364	122-123	N9306225	121	N9308015	132
N9304365	122	N9306345	29	N9308016	133
N9304366	122	N9306346	29	N9308017	132
N9304367	122-123	N9306752	92	N9308018	132
N9304368	122	N9306755	92-93	N9308021	134
N9304369	122	N9306757	93	N9308023	132
N9304372	122	N9306758	92	N9308024	133
N9304373	122	N9307102	128	N9308025	132
N9304375	123	N9307103	115	N9308027	133
N9304376	123	N9307104	116	N9308029	132
N9304377	123	N9307105	116	N9308030	133
N9304379	123	N9307106	116	N9308031	132
N9304380	123	N9307107	116	N9308032	132
N9304382	123	N9307108	116	N9308033	132
N9304383	123	N9307109	117	N9308034	132
N9304384	109	N9307110	117	N9308035	134
N9304385	109	N9307111	115	N9308036	134
N9304600	34	N9307112	115	N9308037	133
N9304601	34	N9307113	113	N9308041	132
N9304602	34	N9307114	113	N9308042	134
N9304603	34	N9307115	113	N9308044	132
N9304604	34	N9307116	113	N9308045	132
N9304605	34	N9307117	111	N9308048	133
N9304606	34	N9307118	115	N9308049	133
N9304607	34	N9307119	115	N9308050	133
N9304608	34	N9307503	92	N9308056	133
N9304609	34	N9307504	92	N9308058	133
N9304610	34	N9307509	92	N9308059	133
N9304611	34	N9307511	92	N9308060	133
N9304612	34	N9307512	92	N9308063	134
N9304613	34	N9307517	92	N9308065	132
N9304614	34	N9307519	92	N9308066	133
N9304615	34	N9307521	92	N9308067	134
N9304616	34	N9307522	92	N9308068	134
N9304618	34	N9307523	92	N9308069	134
N9304619	34	N9307738	115	N9308070	134
N9304620	34	N9307739	128	N9308073	132
N9304621	34	N9307740	127	N9308133	127
N9304622	34	N9307741	114	N9308150	93
N9304623	34	N9307760	92	N9308151	126
N9304624	34	N9307805	115	N9308152	126
N9304625	34	N9307806	115	N9308153	126
N9304626	34	N9307807	115	N9308154	126
N9304627	34	N9307808	115	N9308155	126
N9304628	34	N9307809	117	N9308156	126
N9304629	34	N9307810	117	N9308157	126
N9304630	34	N9307830	30	N9308158	126
N9304631	34	N9307831	30	N9308160	126
N9304632	34	N9307832	30	N9308161	126
N9304633	34	N9307833	30	N9308162	126
N9304634	34	N9307834	32	N9308163	126
N9304642	30	N9307835	32	N9308164	126
N9304643	30	N9308000	134	N9308165	126
N9304644	30	N9308001	134	N9308166	126
N9304645	30	N9308002	132	N9308167	126

PART NUMBER INDEX

Part No.	Page	Part No.	Page	Part No.	Page
N9308168	126	N9308248	125	N9308329	125
N9308169	126	N9308249	125	N9308330	125
N9308170	126	N9308251	125	N9308331	134
N9308171	126	N9308252	125	N9308332	134
N9308173	127	N9308258	125	N9308333	126
N9308174	127	N9308259	126	N9308334	125
N9308175	127	N9308262	126	N9308337	127
N9308176	127	N9308263	126	N9308338	127
N9308177	127	N9308264	126	N9308339	127
N9308178	127	N9308265	126	N9308340	133
N9308179	127	N9308266	126	N9308341	128
N9308181	127	N9308270	126	N9308342	128
N9308182	127	N9308279	127	N9308343	128
N9308198	126	N9308280	127	N9308344	128
N9308199	126	N9308281	127	N9308345	128
N9308200	124	N9308282	127	N9308346	128
N9308201	124	N9308283	127	N9308350	127
N9308202	124	N9308284	127	N9308351	127
N9308203	124	N9308285	127	N9308352	127
N9308204	124	N9308286	128	N9308354	127
N9308205	124	N9308287	128	N9308355	125
N9308206	124	N9308288	128	N9308356	125
N9308207	124	N9308289	128	N9308357	125
N9308208	124	N9308290	128	N9308358	125
N9308209	124	N9308291	128	N9308359	125
N9308210	124	N9308292	128	N9308360	125
N9308211	124	N9308293	128	N9308361	125
N9308212	124	N9308294	128	N9308362	125
N9308213	124	N9308295	128	N9308363	125
N9308214	124	N9308296	128	N9308364	125
N9308215	124	N9308298	127	N9308365	125
N9308216	124	N9308300	125	N9308366	125
N9308217	124	N9308301	125	N9308367	125
N9308218	124	N9308302	125	N9308368	125
N9308219	124	N9308303	125	N9308369	126
N9308220	124	N9308304	125	N9308370	126
N9308221	124	N9308305	125	N9308371	125
N9308222	124	N9308306	125	N9308372	125
N9308223	124	N9308307	125	N9308373	125
N9308224	124	N9308308	125	N9308374	125
N9308225	124	N9308309	125	N9308375	127
N9308226	124	N9308310	125	N9308376	127
N9308227	124	N9308311	125	N9308377	127
N9308228	124	N9308312	125	N9308378	126
N9308229	124	N9308313	125	N9308379	126
N9308230	124	N9308314	128	N9308380	127
N9308231	124	N9308315	125	N9308381	134
N9308232	124	N9308316	125	N9308382	134
N9308233	124	N9308317	125	N9308383	133
N9308234	124	N9308318	125	N9308384	125
N9308235	124	N9308319	125	N9308387	125
N9308236	124	N9308320	125	N9308388	126
N9308237	124	N9308321	125	N9308389	126
N9308238	124	N9308322	124	N9308390	128
N9308239	125	N9308323	124	N9308391	128
N9308241	125	N9308324	125	N9308392	128
N9308242	125	N9308325	125	N9308393	128
N9308243	125	N9308326	125	N9308394	128
N9308245	125	N9308327	125	N9308395	128
N9308247	125	N9308328	125	N9308396	126

Part No.	Page	Part No.	Page	Part No.	Page
N9308397	126	N9309006	35	WE017142	83
N9308398	126	N9309007	35	WE018034	82, 86
N9308399	126	N9309008	35	WE021137	83, 86
N9308540	128	N9309009	35	WE021140	83, 86
N9308541	113	N9309010	35	WE021816	78, 85-86
N9308542	113	N9309011	35	WE023948	77, 85-86
N9308543	113	N9309012	35	WE023951	77-78
N9308544	114	N9309013	35	WE024371	68
N9308545	114	N9309017	35	WE024375	68, 84-85
N9308546	114	N9309019	35	WE024782	77
N9308547	114	N9309020	35	WE025221	73, 86
N9308548	114	N9309021	35	WE027005	77
N9308549	114	N9309024	35	WE027030	77
N9308550	121	N9309025	35	WE027484	83
N9308551	126	N9309026	35	WE027802	83, 86
N9308552	126	N9309027	35	WE027803	83, 86
N9308553	127	N9309028	35	WE029011	82
N9308554	127	N9309029	35		
N9308555	127	N9309030	35		
N9308571	121	N9309031	35		
N9308591	115, 120	N9309032	35		
N9308592	115, 120	N9309033	35		
N9308700	134	N9309034	35		
N9308701	134	N9309035	35		
N9308702	134	N9309036	35		
N9308703	132	N9309066	35		
N9308704	132	N9309103	35		
N9308705	133	W1008384	79		
N9308706	132	W1008572	78		
N9308707	132	W1008573	78		
N9308708	133	W1010620	82		
N9308711	133	W1012406	77, 78, 85-86		
N9308712	133	W1012408	76, 78		
N9308713	133	W1012409	76, 78		
N9308714	128	W1013195	82		
N9308715	128	W1013266	76, 78		
N9308716	128	W1013361	82		
N9308717	128	W1013545	76, 78		
N9308718	128	W1017871	82		
N9308719	128	W1020668	79		
N9308720	128	W1020672	79		
N9308721	128	W1020996	86		
N9308722	128	W1024879	76		
N9308723	128	W1026356	83-85		
N9308724	128	W1026907	83-85		
N9308725	128	W1033612	83-85		
N9308726	128	W1033614	83-85		
N9308727	128	W1033995	83-85		
N9308728	128	W1034694	83		
N9308729	124	W1036712	85, 95		
N9308730	127	W1036713	85, 95		
N9308741	126	W1037485	79		
N9308742	125	W1040148	83-85		
N9308743	125	WE012411	78		
N9308744	125	WE013060	74, 78		
N9308745	125	WE014034	86		
N9308746	125	WE014081	74		
N9308747	125	WE014777	82		
N9308748	125	WE015554	79		
N9309004	35	WE016558	90		

ALPHABETICAL INDEX

1/4 in. (6.4 mm) External Screw Thread.....	36	Calibration Standards Set for Method 6010.....	116
148-Position Tray.....	28	Capricorn Argon Humidifier with Bypass	49
88-Position Tray.....	28	Carbon Fiber Probes for ST Nebulizers	46
AA Test Mix.....	112	Carbon Fiber Supported Autosampler Probes for ST Nebulizers.....	71
AA Ultra Quiet Oil-Less Air Compressor	29	Cassette Torch Mount	79
Accessory Carts.....	106	Catalyst Tube	35
Acetylene Regulator	94	Ceramic Hybrid XLT Quartz Torch.....	59
Acid Number Standards.....	126	Ceramic Pressure Jacket.....	137
Adapters with External Thread.....	36	Cetac ASX Autosamplers and Prep Station	89
Air Compressors.....	29, 64	Cetac Autosampler Racks.....	101
Air Dryer Filter Assembly with R250 Regulator	95	Cetac Autosampler Supplies.....	101
Air Regulator.....	94	Cetac Carbon Fiber Autosampler Probes.....	101
Alternate Reductant Kit.....	38	Cetac Stainless Steel Autosampler Probe	101
Alumina Injectors	62	Cetac Ultem Autosampler Probes	101
Amalgamator Tube.....	35	Check Valves	28
Antifoaming Silicone Emulsion	112	Chiller Noise Enclosure	91
apex High Temperature Nebulizers.....	70	Chillers.....	90
apex PFA Nebulizers	45	Cinnabar™ Cyclonic Spray Chamber.....	50
Aqueous Standards	109	Compressors	29, 64
Argon/Nitrogen Regulator	94	Concentric Nebulizers.....	42, 68
Ari Mist Nebulizers	44	Cone Removal Tool.....	83
Ari Mist Nebulizer Replacement Parts	44	ConeGuard Thread Protectors	83
Asperon™ Spray Chamber.....	73	Cones	83
Atomax Hollow Cathode Lamps	18-19	Conical Bottom Tubes with Graduation	104
Autosamplers.....	89	Conikal™ Nebulizer	43
Autosampler Cups.....	28	Connectors for MicroMist and SeaSpray Nebulizers	69
Autosampler Supplies.....	100	Consumable Run Kits	137
Autosampler Tubes.....	104	Contact Cylinders.....	33
Avio Injector Assembly	63	Contract Lab Program Modification Set.....	115
Avio Injector Assembly Replacement Parts	63	Contract Required Detection Limits (CRDL)	120
Avio Torch	58	Coolant Standards.....	128
Background Corrector Sources	17	Cooling Systems.....	90
Baffled Cyclonic Spray Chambers	51, 73	Copper Ignitor Tape.....	58
Balston® 95A Acetylene Filter	95	Corrosion-Resistant Probes	100
Balston® Air Filter Assembly Type A-82.....	95	Crackle Test Reference Standards.....	127
Base Number Standards	127	Cross-Flow Replacement GemTips and Spares	72
Basic Spares Kit	35	Cyclonic Spray Chambers	50
Benches and Accessory Carts.....	106	Cyclonic/Concentric Kits.....	56
Biodiesel Blends.....	128	D-Torch™ Demountable Torch	60, 79
Biodiesel Standards	128	D-Torch™ and Replacement Parts	60
Blower and Vent Assembly for AA and ICP	94	Demountable and Fixed Quartz Torches.....	79
Burner Head Adjustment Tool.....	20	Demountable Quartz Torches	58, 79
Burner Head Cleaning Tool.....	20	Detection Limit Calibration Standard	128
Burner Heads	20	Detectors	82
Burner System Components	20	Devolatized Diesel Fuel Standards	126
C2 Cyclonic Spray Chambers.....	50	DigiFILTER.....	132
Calibration Standards for Method 200.7	116		

DigiTUBE Caps	133	FIAS/FIMS Cell Replacement Parts	36
DigiTUBES	133	Fixed One Piece Injectors/Torches	59, 77
DPC Clamp Screw for Glass Prism	137	Flangeless Ferrule	38
DPC Glass Prism	137	Flashback Arrestor	39
DPC Glass-Ring for High Pressure 100 mL (100 Bar) Digestion Vessel	137	Flow Injection Connectors	36
DPC Glass-Ring for Standard 75 mL (40 Bar) Digestion Vessel	137	Flow Injection Furnace Supplies	37
DPC O-Ring for Digestion Vessel Caps	137	Flow Injection Sampling Supplies	38
DPC Polarization foil for Digestion Vessel caps	137	Flow Injection System	36
DPC TFM Cap Insert	137	Fuel Dilution Standards	126
DPC Viton O-Ring (25 x 3 mm) for Digestion Vessel caps	137	Fume Hoods	134
DuraMist Nebulizers	44, 69	Furnace Autosampler Trays	28
DV Oxygen Addition Kit	57	Furnace Sampling Probe	28
EDL Driver Assemblies	17	Fused Silica Obstruction Removal Kit	49
EDL Driver Components	17	Gas Containment Manifold Spares	137
Eight Position Lip Seal Forming Tool for High Pressure 100 mL (100 Bar) Digestion Vessel Pressure Seals	136	Gas/Liquid Separator	37
Eight Position Lip Seal Forming Tool for Standard 75 mL (40 Bar) Digestion Vessel Pressure Seals	136	GemClean Cross-Flow II Nebulizer Replacement Parts	72
ELAN Baffled Quartz Cyclonic PC3 Spray Chambers	74	GemClean Nebulizer	72
ELAN Consumable Kits	86	GemCone Nebulizer Replacement Parts	47
ELAN® DRC II Spares Kit	86	GemCone Nebulizers	47
ELAN® DRC-e/9000 Spares Kit	86	GemTip Cross-Flow II Nebulizer Tip Kits	47
Electrically Heated Mantle (Cell) Adapter Cables	38	GemTip Cross-Flow II Nebulizers	47
Electrodeless Discharge Lamps	16-17	GemTip Cross-Flow II Nebulizer Replacement Parts	48
Elegra Argon Humidifier	49	GemTip Nebulizer O-Ring Kit	47
End Cap for Concentric Glass, GemCone and Similar Nebulizers	55	GemTip Nebulizers	47
End Cap for Concentric Nebulizers	69	GemTip Nebulizers for AAnalyst	26
Environmental Analysis Standards	115	Geological Sample Introduction Kit	80
Environmental EPA Set	117	GFAAS Mixed Standard	112
Environmental Method Sets	115	Glass Cyclonic Sample Introduction System for ELAN	86
Environmental Standard Kits	115	Glass Gas/Liquid Separator	37
ESI Autosampler Probes	102, 129	Glass Spray Chambers	50
ESI Autosampler Rack	103	Glycerol	112
ESI Autosampler Supplies	102	Gold Nanoparticle Standards	123
ESI Demountable Injectors	62	Graphite Cooling Ring for Quartz Cells	39
ESI DX Autosamplers	89	Graphite Furnace Accessories and Spare Parts	31
Exhaust Tube 1.5 m	135	Graphite Furnace Autosampler Cups	28
Extended Run Battery Cabinets	93	Graphite Tubes with Advanced Platform	32
Extended Spares Parts Kit	35	Grooved Pyrocoated Graphite Tubes	32
External Exhaust System 230V 50/60 Hz	135	Heated Racks	103
FAST High Productivity Systems	75, 87	HF Resistant Spray Chambers	52
FAST Valve Connecting Lines	68	HF Sample Introduction Kit	76
FAST Valve Connecting Lines for MEINHARD® Plus Nebulizers	42	HF-Resistant Internal Standard Kit	98
FIAS Accessories Case	38	HGA Contact Removal Tool	33
		HGA Graphite Tubes	32
		HGA Instrument Mirror	33
		High Efficiency Demountable Quartz Torch	79
		High Efficiency MicroFlow Nebulizers	45, 70

ALPHABETICAL INDEX

High Pressure 100 mL (100 Bar) Digestion Vessel	
Opening Station	136
High-Sensitivity Nebulizer Parts	25
High Vacuum Silicon Grease	82
High-Sensitivity Nebulizer with Pt/Ir Capillary	22
Hose Assemblies	94
Humidifiers	49, 72
Hydride Accessory Kit	57
Hyper Skimmer Cone and Spares	83
ICH Standards	122-123
ICP Filter Replacement Parts	95
ICP-MS Single Cell Sample Introduction Kits	129
ICP-OES Solutions	118
Immersion Tube (Pipette Tip)	39
Initial Calibration Verification Standards	119
Injector Adapter Kits and O-Rings	78
Injector Assemblies	78
Injector Support Adapter O-Ring Kits	63
Injector Support Adapter O-Rings	78
Injector Support Adapters	63, 78
Injectors	62, 77
Injectors for Demountable Torches	77
Instrument Benches	106
Instrument Calibration Standards	118
Instrument Calibration Standards for CLP	119
Instrument Filters	95
Instrument Setup Solutions	118
Interference Check Standards	119
Interference Solutions for Method 200.7	116
Interference Solutions for Method 6010	116
Internal Standard Addition Kits	99
Internal Standard Addition Tees	99
Internal Standard Kits	98
Internal Standard Mix	115
Internal Standard Set for Method 6010 and 200.7	116
Internal Standard Solutions	120
Internal Standards	125
Ion Lens	82
Ion Optics	82
IsoMist Temperature Controlled Spray Chambers	53, 76
Isotope Standard	121
Kalrez O-Ring Kits for Sampling Accessories	27
Karl Fischer Standards	127
L'vov Platforms	33
Lamp Adapters	17
Large Racks	103
Load Coils	78
LumiCoil™ Plasma Load Coil	78
Lumina Hollow Cathode Lamps	14
Mass Spectrometer Hardware	82
Matrix Blanks	121
Matrix Modifiers for Graphite Furnace AA	31, 33, 112
Matrix Oils and Solvents	126
MEINHARD® Nebulizers	42, 68
Mercury Analyzer Supplies	35
Mercury/Hydride Systems	39
Metal Additive Standards	126
Metal Ball Joint Clip	51
Metal Body Corrosion-Resistant Nebulizers	23
Metal Body Nebulizer Parts	24, 26
Metal Body Platinum Alloy Nebulizers	23
Metal Body Stainless Steel Nebulizers	23
Metallo-Organic Standards	108, 124
MHS-15	39
Micro Racks	103
MicroMist Nebulizer Replacement Parts	43
MicroMist™ Nebulizers	43, 69
Microtiter Plates	103
Mira Mist® Nebulizers	44
Mira Mist® Nebulizer Replacement Parts	44
Mixed Calibration Standards	114
Mixing Block	37
Mixing Manifold for Glass Gas/Liquid Separator	37
Mixing/Separation Assembly	37
Modified THGA Contact Cylinders	31
Mounting Block	55
MP² Two-Stop Peristaltic Pump Tubing	97
Multi-Element Standards	113-114
Nafion® Single Tube Dryer	38
Nebulizers	22, 42, 68
Nebulizer Accessories	27
Nebulizer Assemblies	24
Nebulizer Capillary Tubing	27
Nebulizer Cleaners	49, 72
Nebulizer Cleaning Wires	27
Nebulizer Clip	42
Nebulizer Grease	27
Nebulizer Selection Guide	43
Nebulizer Solution Fitting	42
Nebulizers and Assemblies Quick Reference	27
Nebulizers with Integrated Probes	46
NexION Consumable Kits	84
NexION O-Ring Free Baffled Cyclonic PC³ Spray Chambers	74
Nickel Boats	35

Nickel Sampler and Skimmer Cones.....	83	PFA MicroFlow Nebulizers with Integrated Autosampler Probes.....	46
Nitrogen Purge Gas Generator	61	PFA MicroFlow Nebulizers with Integrated Autosampler Probes (Carbon Fiber Support).....	102
Nitrous Oxide Regulator	94	PFA MicroFlow Nebulizers with Integrated Autosampler Probes (Ultem Support)	102
Noise Enclosures for Vacuum Pumps.....	91	PFA MicroFlow Nebulizers with Integrated Autosampler Probes for NexION 300/350.....	71
Non HF-Resistant Internal Standard Kit	98	PFA MicroFlow Nebulizers with Integrated Capillaries for NexION 300/350.....	71
Non-Coded Intensitron Lamp Plug Adapter	17	PFA Nebulizer Obstruction Removal Kit.....	72
Non-PFA Bottles and Vials.....	105	PFA Nebulizer Replacement Parts.....	70
Oil-Less Air Compressors	64	PFA Nebulizers.....	70
OilExpress Standards	127	PFA Nebulizers with Integrated Autosampler Probes for NexION 1000/2000	71
On-Line Conditioned Uninterruptable Power Supply Systems	93	PFA Nebulizers with Integrated Capillaries for NexION 1000/2000	71
Online Mixing Kits.....	48	PFA Nebulizers with Integrated Fluoropolymer Capillaries.....	46
OpalMist Nebulizers	44, 69	PFA Sample Vessels.....	105
Organics Kits.....	57	PFA Spray Chambers	52, 74
Organics Sample Introduction Kit (Orange).....	80	PFA-Platinum HF-Resistant Sample Introduction Kit.....	80
Organics Sample Introduction System.....	54	PFA-ST Nebulizer	45, 70
Original SimulScan Dual-Stage Detector	82	PFA-ST Self-aspirating Nebulizer for prepFAST Systems	45
Oxygen Addition Kits.....	57	PFA-ST3 Nebulizer	45, 70
Oxygen Port Spray Chamber.....	51	Pharmaceutical Analysis Standards	122
Parker Balston® 73-099 AA Gas Purifier	95	PinAAcle Burner System Components.....	21
Parker Balston® Replacement Filters.....	95	PinAAcle High-Sensitivity Nebulizer.....	22
PC ³ Peltier Coolers.....	75-76	PinAAcle Nebulizers and Assemblies Quick Reference	27
PC ³ Peltier Temperature Controlled Spray Chambers.....	53	Plastic Body GemTip™ Nebulizers	23
PC ³ Replacement Spray Chambers.....	74	Plastic Body Nebulizer Parts for AAnalyst AA Instruments	25
PC ^{3x} Peltier Controlled Heated or Cooled Thermally Stabilized Inlet Systems.....	75	Plastic Body Nebulizer Parts for PinAAcle AA Instrument.....	24
PC ^{3x} Thermally Stabilized Inlet System.....	75	Platinum Sampler and Skimmer Cones	83
Pearl Nebulizer Cleaner	49	Pliers and Accessories	28
PEEK Ari Mist	44	Plug Connector; Mixing Manifold to Gas/Liquid Separator	37
PEEK Mira Mist.....	44	PolyCon™ Nebulizer	44
PEEK Ring Nut for High Pressure 100 mL	137	PolyPro-ST Nebulizer.....	45, 70
PEEK Ring Nut Removal Tool.....	137	Polyscience Replacement Air Filters.....	95
Performance Verification Standards	120-121	PolyScience® WhisperCool™ Refrigerated Chiller	90
<i>pergo</i> Argon Nebulizer	49, 72	Power Conditioners.....	92
Peristaltic Pump Tubing.....	96	Power Conditioners and UPS Systems.....	92
PerkinElmer AS-90/90A/90plus Sample Racks	101	prepFAST Autodilution and Autocalibration Systems.....	65, 87
PerkinElmer AS-91 Sample Racks.....	101	Pressure Seal for High Pressure 100 mL (100 Bar) Digestion Vessels	137
PerkinElmer AS-93plus/S10 Rinsing Kit	101	Pressure Seal for Standard 75 mL (40 Bar) Digestion Vessels	137
PerkinElmer AS-93plus/S10 Sample Racks.....	101	Proficiency Testing Standards.....	128
PerkinElmer AS-9x/S10 Sampling Probe Assemblies	100	PTFE 2 mL Sample Weighing Cup	136
PerkinElmer Autosampler Supplies.....	100-101		
PerkinElmer S10 Autosampler.....	89		
PerkinElmer S10 Autosampler Probes for ST Nebulizers.....	71		
PerkinElmer SMS 100 Mercury Analyzer	35		
Petroleum Physical Test Standard	128		
PFA Bottles and Vials	105		
PFA Gas Quick Connect.....	42		
PFA Injector Assemblies	78		

ALPHABETICAL INDEX

PTFE Membrane	37	Sample Introduction Kit for NexION 2000 Base Configuration (Blue)	80
PTFE Mira Mist	44	Sample Introduction Kit for NexION 2000 Core Configuration (Green)	80
PTFE Probes	100	Sample Introduction Kit for NexION 2000 Productivity Configuration (Black)	81
PTFE Sample Capillaries	70	Sample Introduction Kit for NexION 2000 Semi-Conductor Configuration	81
PTFE Tubing	37	Sample Introduction Kits	56, 76
PTFE Tubing Assemblies	37	Sample Introduction Kits for NexION 1000/2000	80
Pump Magazines	38	Sample Introduction Quick Change Torch Modules	54
Purge Component Replacement Parts	61	Sample Loops	37
Purge Extension Windows	61	Sample Preparation Blocks and Controllers	131
PVC Tubing	37	Sampler and Skimmer Cone O-Rings	83
PVDF Autosampler Vials	105	Sampler and Skimmer Cones	83
Pyrocoated Advanced Platform Graphite Tubes	32	Sampling Probe Assembly Components	100
Pyrocoated Graphite Tube with L'vov Platform	33	Sapphire Injectors	62, 77
Pyrocoated Graphite Tubes with Integrated Platforms	32, 33	Scott Spray Chambers	52, 74
Pyrocoated Graphite Tubes	32	Scott Spray Chamber Replacement Parts	52
Quality Control Standards	114	Scott/Cross-Flow II Kits	56
Quartz Ball Joint Injectors	77	Screw Caps	133
Quartz Cells	39	SeaSpray™ Nebulizers	43, 69
Quartz Cyclonic Sample Introduction System for ELAN	86	SeaSpray™ Nebulizer Replacement Parts	43
Quartz Injectors	62, 77	Setup Solutions	125
Quartz Spray Chambers	50	ShadowStop	82
Quick Change Torch Module Cyclonic Spray Chamber/Concentric Nebulizer	54	Silicone Sleeve for Quartz Cells	39
Quick Change Torch Module Scott Spray Chamber/Cross-Flow Nebulizer	54	Silicone Tubing	37
Quick-Change Torch Module for HF Analysis	55	SimulScan Dual-Stage Detector	82
Quick-Change Torch Module for Oil Analysis	55	Single Cell Kits	129
Quick-Change Torch Module Support Stand	55	Single Lip Seal Forming Tool for High Pressure 100 mL (100 Bar) Digestion Vessel Pressure Seals	136
Quick-Change Torch Module with Cyclonic Spray Chamber and Concentric Nebulizer	55	Single Lip Seal Forming Tool for Standard 75 mL (40 Bar) Digestion Vessel Pressure Seals	136
Quick-Change Torch Module with Scott Spray Chamber and GemTip Cross-Flow II Nebulizer	55	Single-Element Standards	109
Rack Covers	103	Single-Element, Metallo-Organic Standards	124
Reagent Containers	28	Single-Slot Air-Acetylene 10 cm	20
Reagents	112	Single-Slot Air-Acetylene 5 cm	20
Red Filter	17	Single-Slot Nitrous Oxide-Acetylene 5 cm	20
Reductant Reservoir	39	Slurry™ Nebulizer	44
RF Load Coil Accessories	61, 78	SMARTintro Sample Introduction Modules and Cassettes	81
RF Load Coils	61	SmartTune Standards	118
Round Bottom Tubes	104	SMS 100 Consumables and Supplies	35
Rupture Disc for High Pressure 100 mL (100 Bar) Digestion Vessels	137	Solvent Resistant Yellow Peristaltic Pump Tubing	37
Rupture Disc for Standard 75 mL (40 Bar) Digestion Vessels	137	Soot Content Standard Set	127
Sample Capillaries for ST Nebulizers	45	Soot Content Standards	127
Sample Flask	39	Spares and Replacement Parts	137
Sample Introduction Cassettes Only	81	Spares Kits	35
Sample Introduction Kit for NexION 1000 ICP-MS	80	SPB Automatic Shut-Off System	132

SPB Block Racks.....	134
SPB Controllers.....	131
SPBVAC Block.....	134
Spike Standards.....	114
Spray Chamber Accessories.....	51
Spray Chamber Replacement Parts.....	51, 74
Spray Chamber, End Cap and Associated Parts.....	52
Spray Chambers.....	66, 73
Stainless Steel Probes.....	100
Standard Pump Tubing.....	97
Standard Racks.....	103
Standard THGA Graphite Contact Cylinders.....	31
Standard THGA Graphite Tubes.....	30
Standard THGA Graphite Tubes with End Caps.....	30
Start Up Kits.....	132
Storage Racks.....	134
Sulfur Standards.....	128
Super Racks.....	103
Supplies.....	39
Supplies Small Diameter Lamp Adapter Kit.....	17
Switching Valves.....	38
Syringe Flush Kit.....	49, 72
Temperature Controlled Spray Chambers.....	53, 75-76
Temperature Probes.....	132
TFM Sample Vessel Insert.....	137
The Eluo™ Nebulizer Cleaner.....	49, 72
THGA Contact Cylinders.....	31
THGA Graphite Tubes.....	30
THGA Graphite Tubes with Advanced Platform™.....	30
THGA Instrument Mirror.....	31
Three-slot Air-acetylene 10 cm.....	20
Three-Stop Peristaltic Pump Tubing.....	37, 96
Titan MPS Bench.....	135
Titan MPS Systems.....	130, 135
Torch Alignment Tool.....	79
Torch Body Assemblies.....	58
Torch Body Assembly Replacement Parts.....	58
Torch Bonnet.....	58
Torch Injector Replacement Parts.....	77
Torch O-Ring Kits.....	59
Torches.....	66, 58, 79
Toxicity Characteristic Leachate Procedure (TCLP) Standard.....	117
Transfer Hose.....	39
Triton® X-100 Wetting Agent.....	112
Tubes.....	133
Tubes and Vessels.....	130
Tubing.....	37
Turntable Base Ring.....	137
Turntables.....	136
Twinnabar™ Cyclonic Spray Chamber.....	50
Two-Stop Peristaltic Pump Tubing.....	96
UltraClean THGA Graphite Tubes.....	31
Universal Data Calibration Standards Kit.....	121
UPS Systems.....	93
USP Standards.....	122-123
UV Light Shields.....	73
V Oxygen Addition Kit.....	57
V-21 Wear Metal Standards.....	125
V-21+K Wear Metal Standards.....	125
V-23 Wear Metal Standards.....	125
V-26 Wear Metal Standards.....	125
Vacuum Pump Fluid.....	82
Vacuum Pump Noise Enclosure.....	91
Vacuum Pump Noise Reduction Cover.....	91
VeeSpray™ Nebulizer.....	44
VersaTube™.....	133
Vessel Cap Disassembly Tools for High Pressure 100 mL (100 Bar) Digestion Vessel.....	136
Vessel Cap Disassembly Tools for Standard 75 mL (40 Bar) Digestion Vessel.....	136
Vessel Caps.....	136
Vessel Rack Holder.....	136
Vessels.....	136
Viscosity Reference Standards.....	127
Wash Standards.....	121
Watch Glasses.....	133
Water Pollutant Standards.....	117
Wilkerson® Air Dryer Filter Accessories*.....	95

PerkinElmer, Inc.
940 Winter Street
Waltham, MA 02451 USA
P: (800) 762-4000 or
(+1) 203-925-4602
www.perkinelmer.com



For a complete listing of our global offices, visit www.perkinelmer.com/ContactUs

Copyright ©2020, PerkinElmer, Inc. All rights reserved. PerkinElmer is a trademark of PerkinElmer, Inc. All other trademarks are the property of their respective owners.

013993B_02